



Precision Low-Drift 2.048 V/2.500 V SOT-23 Voltage References

ADR380/ADR381

FEATURES

Initial Accuracy: ± 5 mV/ ± 6 mV max
Initial Accuracy Error: $\pm 0.24\%$ / $\pm 0.24\%$
Low TCV₀: 25 ppm/ $^{\circ}$ C max
Load Regulation: 70 ppm/mA
Line Regulation: 25 ppm/V
Wide Operating Range:
2.4 V–18 V for ADR380
2.8 V–18 V for ADR381
Low Power: 120 μ A max
High Output Current: 5 mA
Wide Temperature Range: -40° C to $+85^{\circ}$ C
Tiny 3-Lead SOT-23 Package with Standard Pinout

APPLICATIONS

Battery-Powered Instrumentation
Portable Medical Instruments
Data Acquisition Systems
Industrial Process Control Systems
Hard Disk Drives
Automotive

PIN CONFIGURATION

3-Lead SOT-23
(RT Suffix)

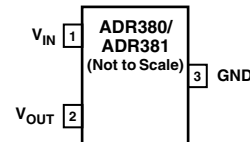

Table I. ADR38x Products

Part Number	Nominal Output Voltage (V)
ADR380	2.048
ADR381	2.500

GENERAL DESCRIPTION

The ADR380 and ADR381 are precision 2.048 V and 2.500 V bandgap voltage references featuring high accuracy, high stability, and low-power consumption in a tiny footprint. Patented temperature drift curvature correction techniques minimize nonlinearity of the voltage change with temperature. The wide operating range and low-power consumption make them ideal for 3 V–5 V battery-powered applications.

The ADR380 and ADR381 are micropower, Low Dropout Voltage (LDV) devices that provide a stable output voltage from supplies as low as 300 mV above the output voltage. They are specified over the industrial (-40° C to $+85^{\circ}$ C) temperature range. ADR380/ADR381 is available in the tiny 3-lead SOT-23 package.

REV. 0

Information furnished by Analog Devices is believed to be accurate and reliable. However, no responsibility is assumed by Analog Devices for its use, nor for any infringements of patents or other rights of third parties which may result from its use. No license is granted by implication or otherwise under any patent or patent rights of Analog Devices.

One Technology Way, P.O. Box 9106, Norwood, MA 02062-9106, U.S.A.
Tel: 781/329-4700 World Wide Web Site: <http://www.analog.com>
Fax: 781/326-8703 © Analog Devices, Inc., 2001

ADR380/ADR381—SPECIFICATIONS

ADR380 ELECTRICAL CHARACTERISTICS (@ $V_{IN} = 5.0\text{ V}$, $T_A = 25^\circ\text{C}$ unless otherwise noted.)

Parameter	Symbol	Conditions	Min	Typ	Max	Unit
Output Voltage	V_O		2.043	2.048	2.053	V
Initial Accuracy Error	V_{OERR}		-5		+5	mV
Temperature Coefficient	TCV_O	$-40^\circ\text{C} < T_A < +85^\circ\text{C}$ $0^\circ\text{C} < T_A < 70^\circ\text{C}$	-0.24	5	+0.24	%
Minimum Supply Voltage Headroom	$V_{IN} - V_O$	$I_L \leq 3\text{ mA}$		300		mV
Line Regulation	$\Delta V_O / \Delta V_{IN}$	$V_{IN} = 2.5\text{ V to } 15\text{ V}$ $-40^\circ\text{C} < T_A < +85^\circ\text{C}$		10	25	ppm/V
Load Regulation	$\Delta V_O / \Delta I_{LOAD}$	$V_{IN} = 3\text{ V}$, $I_{LOAD} = 0\text{ mA to } 5\text{ mA}$ $-40^\circ\text{C} < T_A < +85^\circ\text{C}$			70	ppm/mA
Quiescent Current	I_{IN}	No Load $-40^\circ\text{C} < T_A < +85^\circ\text{C}$		100	120	μA
Voltage Noise	e_N	0.1 Hz to 10 Hz		5		$\mu\text{V p-p}$
Turn-On Settling Time	t_R			20		μs
Long-Term Stability	ΔV_O	1000 Hrs		50		ppm
Output Voltage Hysteresis	V_{O_HYS}			40		ppm
Ripple Rejection Ratio	RRR	$f_{IN} = 60\text{ Hz}$		85		dB
Short Circuit to GND	I_{SC}			25		mA

Specifications subject to change without notice.

ADR380 ELECTRICAL CHARACTERISTICS (@ $V_{IN} = 15.0\text{ V}$, $T_A = 25^\circ\text{C}$ unless otherwise noted.)

Parameter	Symbol	Conditions	Min	Typ	Max	Unit
Output Voltage	V_O		2.043	2.048	2.053	V
Initial Accuracy Error	V_{OERR}		-5		+5	mV
Temperature Coefficient	TCV_O	$-40^\circ\text{C} < T_A < +85^\circ\text{C}$ $0^\circ\text{C} < T_A < 70^\circ\text{C}$	-0.24	5	+0.24	%
Minimum Supply Voltage Headroom	$V_{IN} - V_O$	$I_L \leq 3\text{ mA}$		300		mV
Line Regulation	$\Delta V_O / \Delta V_{IN}$	$V_{IN} = 2.5\text{ V to } 15\text{ V}$ $-40^\circ\text{C} < T_A < +85^\circ\text{C}$		10	25	ppm/V
Load Regulation	$\Delta V_O / \Delta I_{LOAD}$	$V_{IN} = 3\text{ V}$, $I_{LOAD} = 0\text{ mA to } 5\text{ mA}$ $-40^\circ\text{C} < T_A < +85^\circ\text{C}$			70	ppm/mA
Quiescent Current	I_{IN}	No Load $-40^\circ\text{C} < T_A < +85^\circ\text{C}$		100	120	μA
Voltage Noise	e_N	0.1 Hz to 10 Hz		5		$\mu\text{V p-p}$
Turn-On Settling Time	t_R			20		μs
Long-Term Stability	ΔV_O	1000 Hrs		50		ppm
Output Voltage Hysteresis	V_{O_HYS}			40		ppm
Ripple Rejection Ratio	RRR	$f_{IN} = 60\text{ Hz}$		85		dB
Short Circuit to GND	I_{SC}			25		mA

Specifications subject to change without notice.

SPECIFICATIONS

ADR381 ELECTRICAL CHARACTERISTICS (@ $V_{IN} = 5.0\text{ V}$, $T_A = 25^\circ\text{C}$ unless otherwise noted.)

Parameter	Symbol	Conditions	Min	Typ	Max	Unit
Output Voltage	V_O		2.494	2.5	2.506	V
Initial Accuracy Error	V_{OERR}		-6		+6	mV
			-0.24		+0.24	%
Temperature Coefficient	TCV_O	$-40^\circ\text{C} < T_A < +85^\circ\text{C}$		5	25	ppm/ $^\circ\text{C}$
		$0^\circ\text{C} < T_A < 70^\circ\text{C}$		3	21	ppm/ $^\circ\text{C}$
Minimum Supply Voltage Headroom	$V_{IN} - V_O$	$I_L \leq 2\text{ mA}$		300		mV
Line Regulation	$\Delta V_O / \Delta V_{IN}$	$V_{IN} = 2.8\text{ V to } 15\text{ V}$ $-40^\circ\text{C} < T_A < +85^\circ\text{C}$		10	25	ppm/V
Load Regulation	$\Delta V_O / \Delta I_{LOAD}$	$V_{IN} = 3.5\text{ V}$, $I_{LOAD} = 0\text{ mA to } 5\text{ mA}$ $-40^\circ\text{C} < T_A < +85^\circ\text{C}$			70	ppm/mA
Quiescent Current	I_{IN}	No Load $-40^\circ\text{C} < T_A < +85^\circ\text{C}$		100	120	μA
					140	μA
Voltage Noise	e_N	0.1 Hz to 10 Hz		5		$\mu\text{V p-p}$
Turn-On Settling Time	t_R			20		μs
Long-Term Stability	ΔV_O	1000 Hrs		50		ppm
Output Voltage Hysteresis	V_{O_HYS}			75		ppm
Ripple Rejection Ratio	RRR	$f_{IN} = 60\text{ Hz}$		85		dB
Short Circuit to GND	I_{SC}			25		mA

Specifications subject to change without notice.

ADR381 ELECTRICAL CHARACTERISTICS (@ $V_{IN} = 15.0\text{ V}$, $T_A = 25^\circ\text{C}$ unless otherwise noted.)

Parameter	Symbol	Conditions	Min	Typ	Max	Unit
Output Voltage	V_O		2.494	2.5	2.506	V
Initial Accuracy Error	V_{OERR}		-6		+6	mV
			-0.24		+0.24	%
Temperature Coefficient	TCV_O	$-40^\circ\text{C} < T_A < +85^\circ\text{C}$		5	25	ppm/ $^\circ\text{C}$
		$0^\circ\text{C} < T_A < 70^\circ\text{C}$		3	21	ppm/ $^\circ\text{C}$
Minimum Supply Voltage Headroom	$V_{IN} - V_O$	$I_L \leq 2\text{ mA}$		300		mV
Line Regulation	$\Delta V_O / \Delta V_{IN}$	$V_{IN} = 2.8\text{ V to } 15\text{ V}$ $-40^\circ\text{C} < T_A < +85^\circ\text{C}$		10	25	ppm/V
Load Regulation	$\Delta V_O / \Delta I_{LOAD}$	$V_{IN} = 3.5\text{ V}$, $I_{LOAD} = 0\text{ mA to } 5\text{ mA}$ $-40^\circ\text{C} < T_A < +85^\circ\text{C}$			70	ppm/mA
Quiescent Current	I_{IN}	No Load $-40^\circ\text{C} < T_A < +85^\circ\text{C}$		100	120	μA
					140	μA
Voltage Noise	e_N	0.1 Hz to 10 Hz		5		$\mu\text{V p-p}$
Turn-On Settling Time	t_R			20		μs
Long-Term Stability	ΔV_O	1000 Hrs		50		ppm
Output Voltage Hysteresis	V_{O_HYS}			75		ppm
Ripple Rejection Ratio	RRR	$f_{IN} = 60\text{ Hz}$		85		dB
Short Circuit to GND	I_{SC}			25		mA

Specifications subject to change without notice.

ADR380/ADR381

ABSOLUTE MAXIMUM RATINGS¹

Supply Voltage	18 V
Output Short-Circuit Duration to GND	
$V_{IN} > 15\text{ V}$	10 sec
$V_{IN} \leq 15\text{ V}$	Indefinite
Storage Temperature Range	
RT Package	-65°C to +150°C
Operating Temperature Range	
ADR380/ADR381	-40°C to +85°C
Junction Temperature Range	
RT Package	-65°C to +150°C
Lead Temperature Range (Soldering, 60 Sec)	300°C

Package Type	θ_{JA} ²	θ_{JC}	Unit
3-Lead SOT-23 (RT)	333	—	°C/W

NOTES

¹Absolute maximum ratings apply at 25°C, unless otherwise noted.

² θ_{JA} is specified for the worst case conditions, i.e., θ_{JA} is specified for device soldered in circuit board for surface-mount packages.

ORDERING GUIDE

Model	Temperature Range	Package Description	Package Option	Top Mark	Output Voltage	Number of Parts per Reel
ADR380ART-REEL7	-40°C to +85°C	SOT-23	RT-3	R2A	2.048	3,000
ADR380ART-REEL	-40°C to +85°C	SOT-23	RT-3	R2A	2.048	10,000
ADR381ART-REEL7	-40°C to +85°C	SOT-23	RT-3	R3A	2.500	3,000
ADR381ART-REEL	-40°C to +85°C	SOT-23	RT-3	R3A	2.500	10,000

CAUTION

ESD (electrostatic discharge) sensitive device. Electrostatic charges as high as 4000 V readily accumulate on the human body and test equipment and can discharge without detection. Although the ADR380/ADR381 features proprietary ESD protection circuitry, permanent damage may occur on devices subjected to high-energy electrostatic discharges. Therefore, proper ESD precautions are recommended to avoid performance degradation or loss of functionality.

PIN CONFIGURATION

3-Lead SOT-23 (RT Suffix)

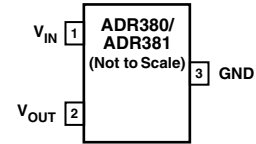

PARAMETER DEFINITIONS

Temperature Coefficient

The change of output voltage over the operating temperature change and normalized by the output voltage at 25°C, expressed in ppm/°C. The equation follows:

$$TCV_o [ppm/°C] = \frac{V_o(T_2) - V_o(T_1)}{V_o(25°C) \times (T_2 - T_1)} \times 10^6$$

where:

$$V_o(25°C) = V_o \text{ at } 25°C.$$

$$V_o(T_1) = V_o \text{ at Temperature 1.}$$

$$V_o(T_2) = V_o \text{ at Temperature 2.}$$

Line Regulation

The change in output voltage due to a specified change in input voltage. It includes the effects of self-heating. Line Regulation is expressed in either percent per volt, parts-per-million per volt, or microvolts per volt change in input voltage.

Load Regulation

The change in output voltage due to a specified change in load current. It includes the effects of self-heating. Load Regulation is expressed in either microvolts per milliampere, parts-per-million per milliampere, or ohms of dc output resistance.

Long-Term Stability

A typical shift in output voltage over 1000 hours at a controlled temperature. The graphs (TPC 24 and TPC 25) show a sample of parts measured at different intervals in a controlled environment of 50°C for 1000 hours.

$$\Delta V_o = V_o(t_0) - V_o(t_1)$$

$$\Delta V_o [ppm] = \frac{V_o(t_0) - V_o(t_1)}{V_o(t_0)} \times 10^6$$

where:

$$V_o(t_0) = V_o \text{ at Time 0.}$$

$$V_o(t_1) = V_o \text{ after 1000 hours' operation at a controlled temperature.}$$

Note that 50°C was chosen since most applications we have experienced run at a higher temperature than 25°C.

Thermal Hysteresis

The change of output voltage after the device is cycled through temperature from +25°C to -40°C to +85°C and back to +25°C. This is a typical value from a sample of parts put through such a cycle.

$$V_{o_HYS} = V_o(25°C) - V_{o_TC}$$

$$V_{o_HYS} [ppm] = \frac{V_o(25°C) - V_{o_TC}}{V_o(25°C)} \times 10^6$$

where:

$$V_o(25°C) = V_o \text{ at } 25°C.$$

$$V_{o_TC} = V_o \text{ at } 25°C \text{ after temperature cycle at } +25°C \text{ to } -40°C \text{ to } +85°C \text{ and back to } +25°C.$$

Typical Performance Characteristics

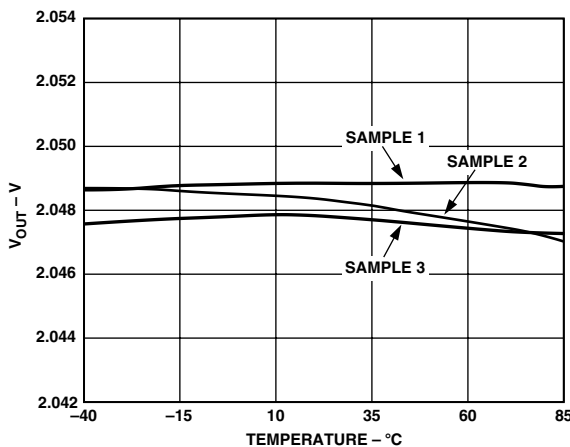

TPC 1. ADR380 Output Voltage vs. Temperature

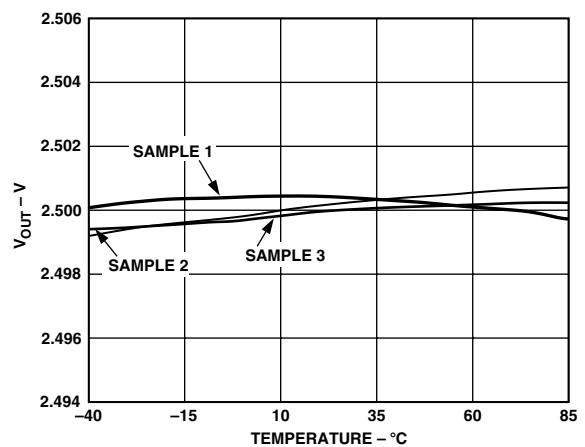

TPC 2. ADR381 Output Voltage vs. Temperature

ADR380/ADR381—Typical Performance Characteristics

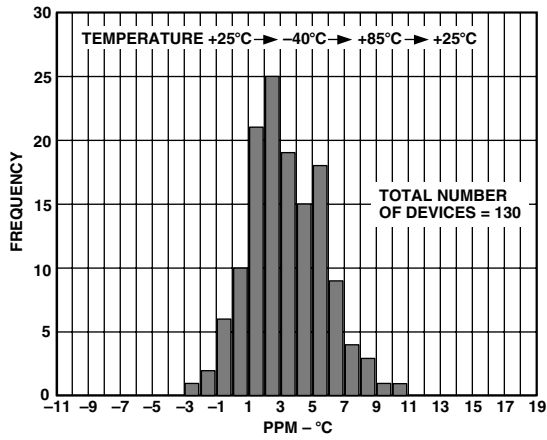

TPC 3. ADR380 Output Voltage Temperature Coefficient

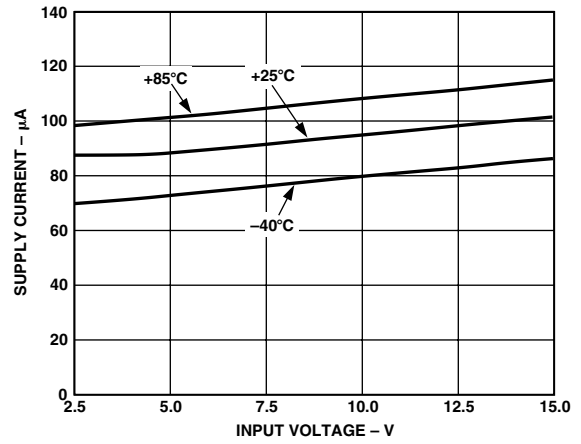

TPC 6. ADR381 Supply Current vs. Input Voltage

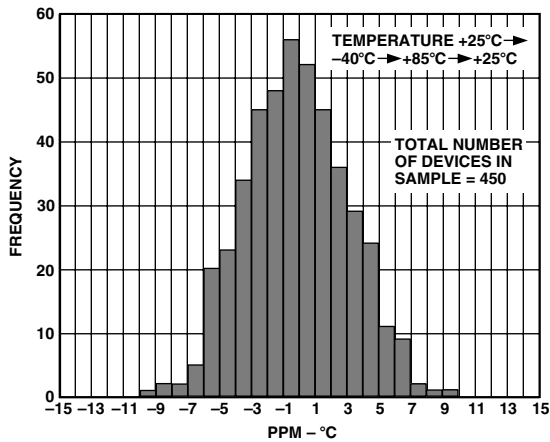

TPC 4. ADR381 Output Voltage Temperature Coefficient

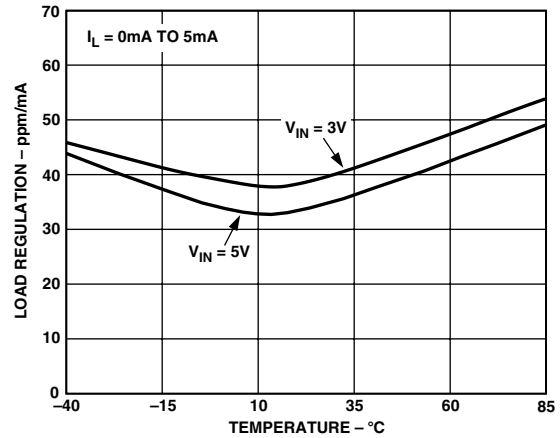

TPC 7. ADR380 Load Regulation vs. Temperature

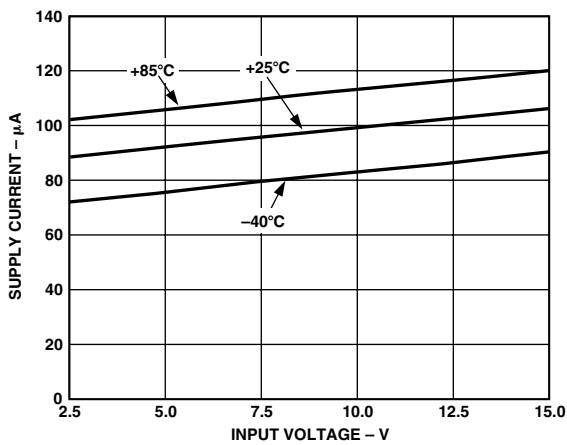

TPC 5. ADR380 Supply Current vs. Input Voltage

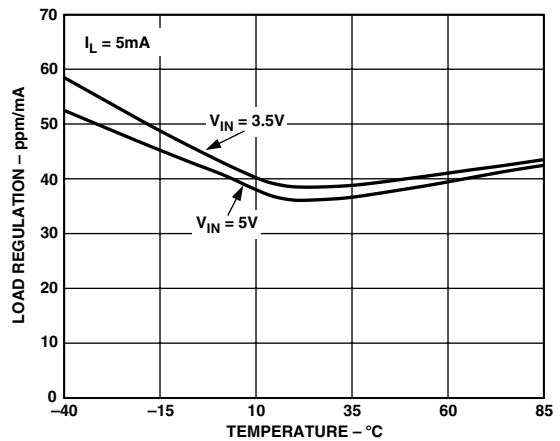

TPC 8. ADR381 Load Regulation vs. Temperature

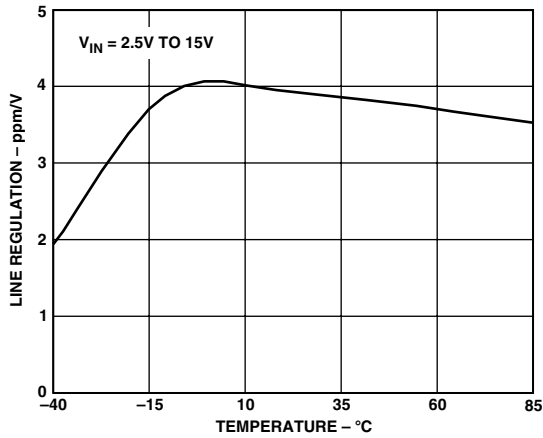

TPC 9. ADR380 Line Regulation vs. Temperature

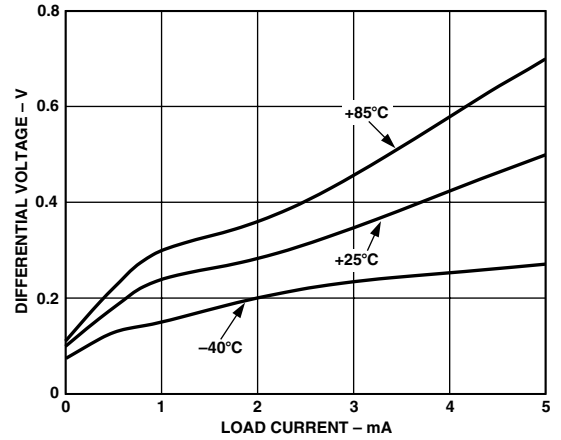

TPC 12. ADR381 Minimum Input/Output Voltage Differential vs. Load Current

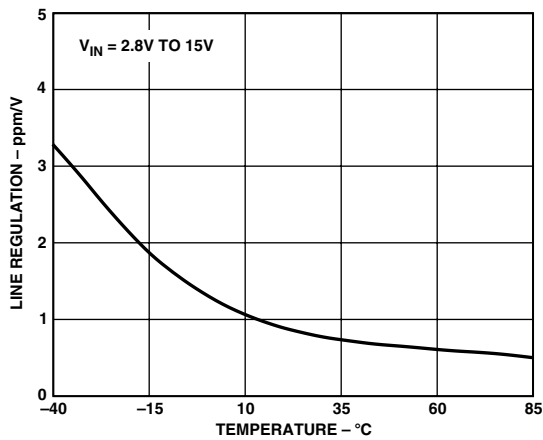

TPC 10. ADR381 Line Regulation vs. Temperature

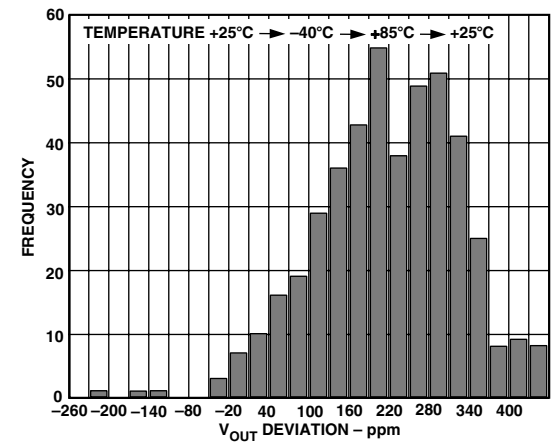

TPC 13. ADR381 V_{OUT} Hysteresis

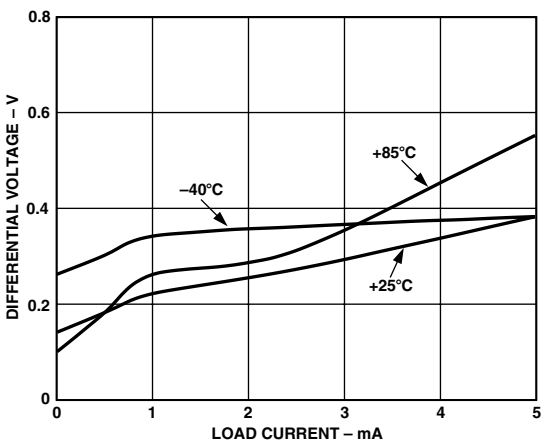

TPC 11. ADR380 Minimum Input/Output Voltage Differential vs. Load Current

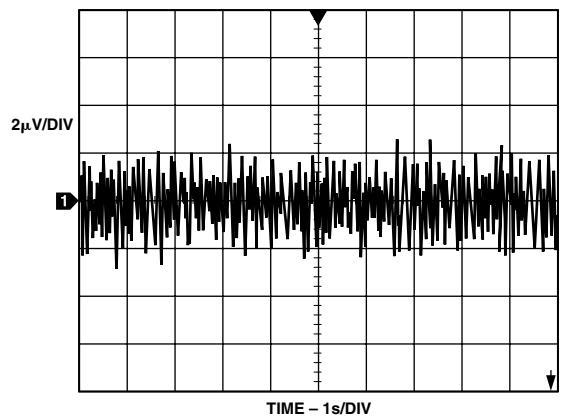

TPC 14. ADR381 Typical Noise Voltage 0.1 Hz to 10 Hz

ADR380/ADR381

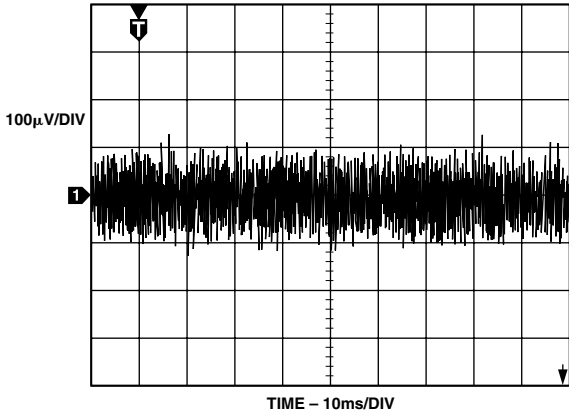

TPC 15. ADR381 Typical Noise Voltage 10 Hz to 10 kHz

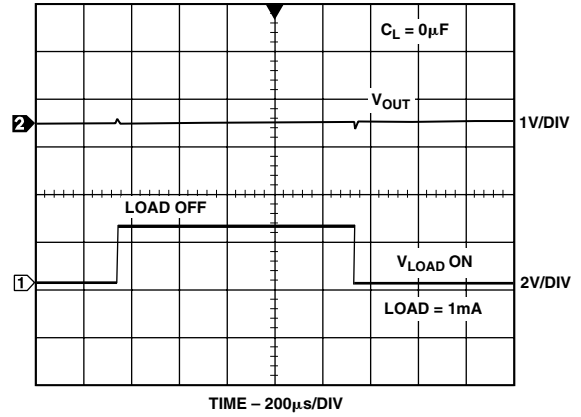

TPC 18. ADR381 Load Transient Response with $C_L = 0 \mu\text{F}$

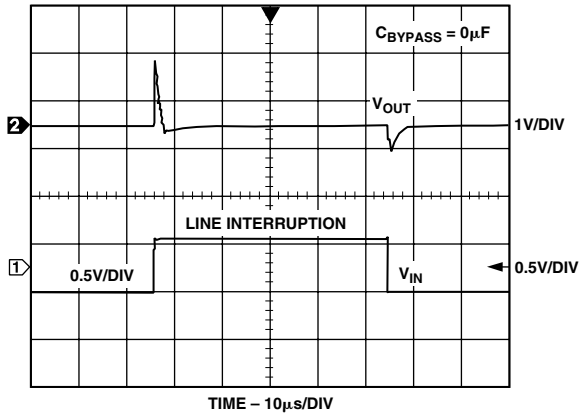

TPC 16. ADR381 Line Transient Response

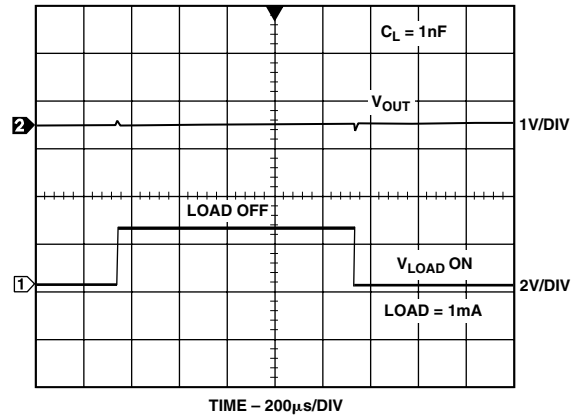

TPC 19. ADR381 Load Transient Response with $C_L = 1 \text{ nF}$

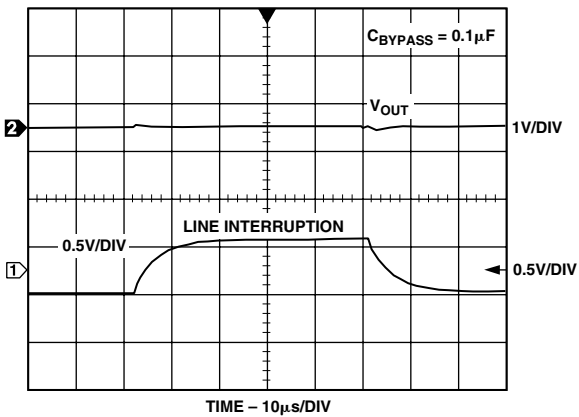

TPC 17. ADR381 Line Transient Response

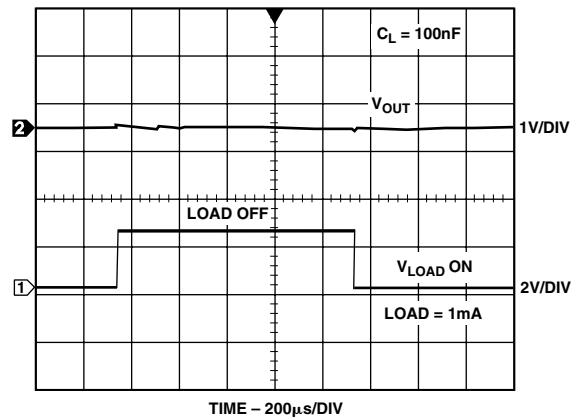

TPC 20. ADR381 Load Transient Response with $C_L = 100 \text{ nF}$

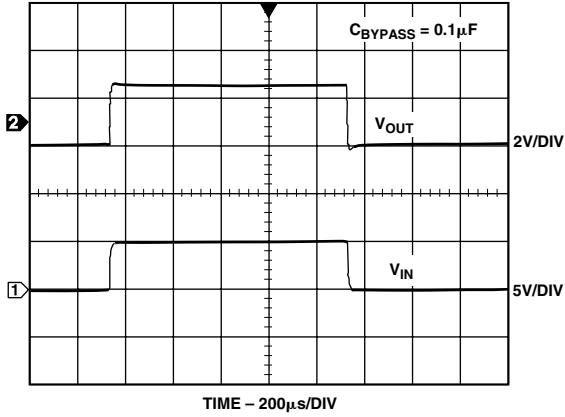

TPC 21. ADR381 Turn-On/Turn-Off Response at 5 V

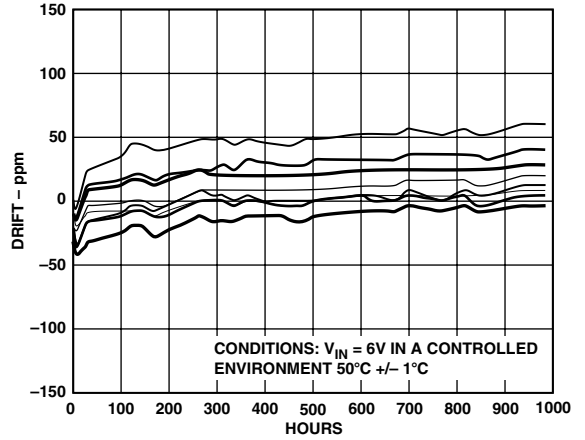

TPC 24. ADR380 Long-Term Drift

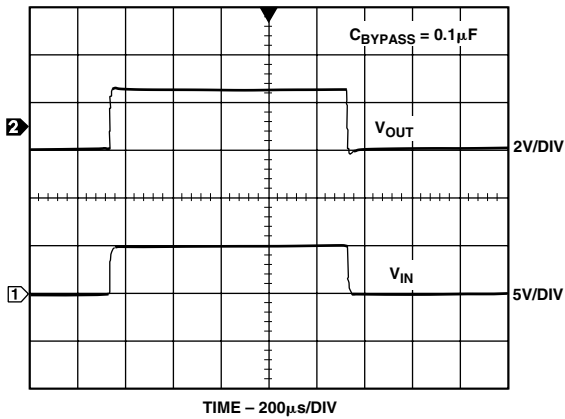

TPC 22. ADR381 Turn-On/Turn-Off Response at 5 V

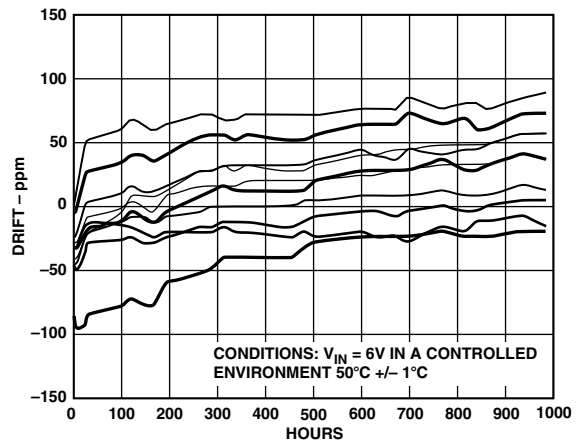

TPC 25. ADR381 Long-Term Drift

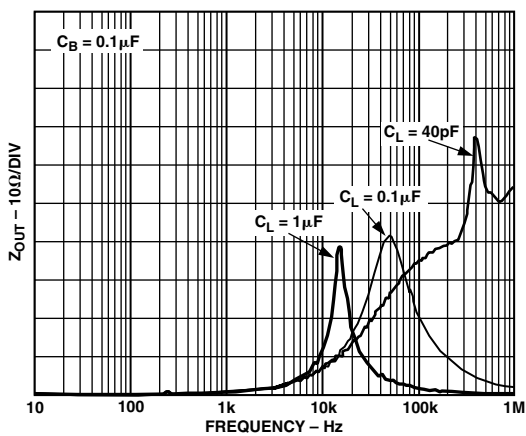

TPC 23. ADR381 Output Impedance vs. Frequency

ADR380/ADR381

THEORY OF OPERATION

Bandgap references are the high-performance solution for low-supply voltage and low-power voltage reference applications, and the ADR380/ADR381 is no exception. But the uniqueness of this product lies in its architecture. By observing Figure 1, the ideal zero TC bandgap voltage is referenced to the output, not to ground. The bandgap cell consists of the pnp pair Q51 and Q52, running at unequal current densities. The difference in V_{BE} results in a voltage with a positive TC which is amplified up by the ratio of $2 \times R58/R54$. This PTAT voltage, combined with V_{BEs} of Q51 and Q52, produce the stable bandgap voltage. Reduction in the bandgap curvature is performed by the ratio of the two resistors R44 and R59. Precision laser trimming and other patented circuit techniques are used to further enhance the drift performance.

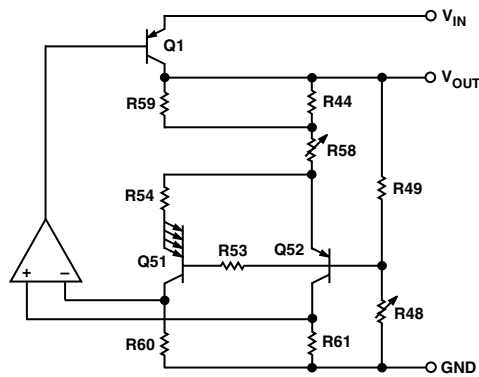

Figure 1. Simplified Schematic

Device Power Dissipation Considerations

The ADR380/ADR381 is capable of delivering load currents to 5 mA with an input voltage that ranges from 2.8 V (ADR381 only) to 15 V. When this device is used in applications with large input voltages, care should be taken to avoid exceeding the specified maximum power dissipation or junction temperature that could result in premature device failure. The following formula should be used to calculate a device's maximum junction temperature or dissipation:

$$P_D = \frac{T_J - T_A}{\theta_{JA}}$$

where:

- P_D is the device power dissipation,
- T_J and T_A are junction and ambient temperatures, respectively, and
- θ_{JA} is the device package thermal resistance.

Input Capacitor

Input capacitor is not required on the ADR380/ADR381. There is no limit for the value of the capacitor used on the input, but a capacitor on the input will improve transient response in applications where the load current suddenly increases.

Output Capacitor

The ADR380/ADR381 does not need an output capacitor for stability under any load condition. An output capacitor, typically 0.1 μF , will take out any very low-level noise voltage, and will not affect the operation of the part. The only parameter that will degrade by putting an output capacitor here is turn-on

time. (This will vary depending on the size of the capacitor.) Load transient response is also improved with an output capacitor. A capacitor will act as a source of stored energy for a sudden increase in load current.

APPLICATIONS

Stacking Reference ICs for Arbitrary Outputs

Some applications may require two reference voltage sources which are a combined sum of standard outputs. The following circuit shows how this "stacked output" reference can be implemented:

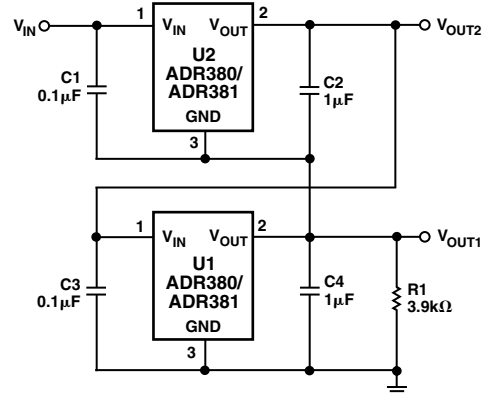

Figure 2. Stacking Voltage References with the ADR380/ADR381

Two ADR380s or ADR381s are used; the outputs of the individual references are simply cascaded to reduce the supply current. Such configuration provides two output voltages V_{OUT1} and V_{OUT2} . V_{OUT1} is the terminal voltage of U1, while V_{OUT2} is the sum of this voltage and the terminal voltage of U2. U1 and U2 can be chosen for the two different voltages that supply the required outputs.

While this concept is simple, a precaution is in order. Since the lower reference circuit must sink a small bias current from U2, plus the base current from the series PNP output transistor in U2, the external load of either U1 or R1 must provide a path for this current. If the U1 minimum load is not well-defined, the resistor R1 should be used, set to a value that will conservatively pass 600 μA of current with the applicable V_{OUT1} across it. Note that the two U1 and U2 reference circuits are locally treated as macrocells, each having its own bypasses at input and output for optimum stability. Both U1 and U2 in this circuit can source dc currents up to their full rating. The minimum input voltage, V_S , is determined by the sum of the outputs, V_{OUT2} , plus the 300 mV dropout voltage of U2.

A Negative Precision Reference without Precision Resistors

In many current-output CMOS DAC applications where the output signal voltage must be of the same polarity as the reference voltage, it is often required to reconfigure a current-switching DAC into a voltage-switching DAC through the use of a 1.25 V reference, an op amp, and a pair of resistors. Using a current-switching DAC directly requires an additional operational amplifier at the output to reinvert the signal. A negative voltage reference is then desirable from the point that an additional operational amplifier is not required for either reinversion (current-switching mode) or amplification (voltage-switching mode) of the DAC

output voltage. In general, any positive voltage reference can be converted into a negative voltage reference through the use of an operational amplifier and a pair of matched resistors in an inverting configuration. The disadvantage to this approach is that the largest single source of error in the circuit is the relative matching of the resistors used.

The circuit in Figure 3 avoids the need for tightly matched resistors with the use of an active integrator circuit. In this circuit, the output of the voltage reference provides the input drive for the integrator. The integrator, to maintain circuit equilibrium, adjusts its output to establish the proper relationship between the reference's V_{OUT} and GND. Thus, any negative output voltage desired can be chosen by simply substituting for the appropriate reference IC. A precaution should be noted with this approach: although rail-to-rail output amplifiers work best in the application, these operational amplifiers require a finite amount (mV) of headroom when required to provide any load current. The choice for the circuit's negative supply should take this issue into account.

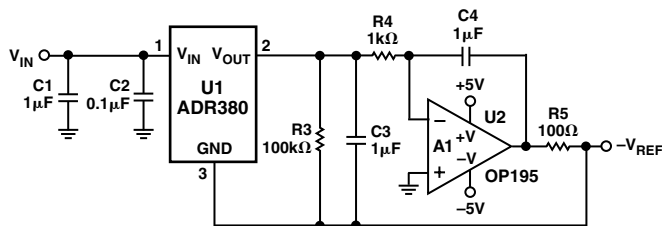

Figure 3. A Negative Precision Voltage Reference Uses No Precision Resistors

Precision Current Source

Many times in low-power applications, the need arises for a precision current source that can operate on low supply voltages. As shown in Figure 4, the ADR380/ADR381 can be configured as a precision current source. The circuit configuration illustrated is a floating current source with a grounded load. The reference's output voltage is bootstrapped across R_{SET} ($R1 + P1$), which sets the output current into the load. With this configuration, circuit precision is maintained for load currents in the range from the reference's supply current, typically 90 μ A to approximately 5 mA.

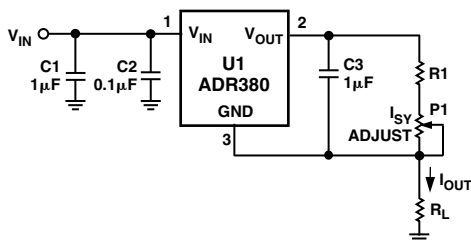

Figure 4. A Precision Current Source

Precision High-Current Voltage Source

In some cases, the user may want higher output current delivered to a load and still achieve better than 0.5% accuracy out of the ADR380/ADR381. The accuracy for a reference is normally specified on the data sheet with no load. However, the output voltage changes with load current.

The circuit in Figure 5 provides high current without compromising the accuracy of the ADR380/ADR381. By op amp action, V_O follows V_{REF} with very low drop in $R1$. To maintain circuit equilibrium, the op amp also drives the N-Ch MOSFET Q1 into saturation to maintain the current needed at different loads. $R2$ is optional to prevent oscillation at Q1. In such an approach, hundreds of milliamp of load current can be achieved and the current is limited by the thermal limitation of Q1. $V_{IN} = V_O + 300$ mV.

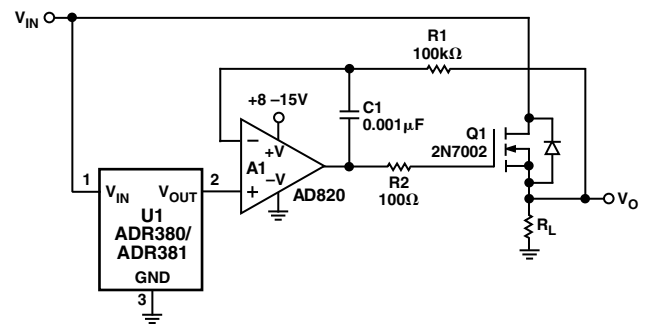

Figure 5. ADR380/ADR381 for Precision High-Current Voltage Source

ADR380/ADR381

OUTLINE DIMENSIONS

Dimensions shown in inches and (mm).

Surface Mount Package (RT-3)

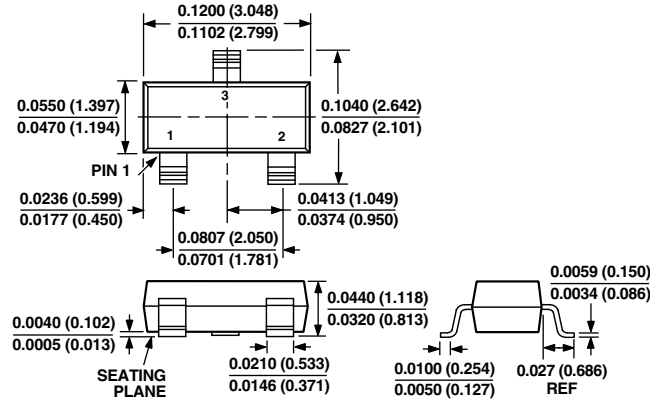

TAPE AND REEL DIMENSIONS

Dimensions shown in inches and (mm).

