

FEATURES

Low Supply Current: 600 μ A Max

OP07 Type Performance

Offset Voltage: 20 μ V Max

Offset Voltage Drift: 0.6 μ V/ $^{\circ}$ C Max

Very Low Bias Current

25 $^{\circ}$ C: 100 pA Max

-55 $^{\circ}$ C to +125 $^{\circ}$ C: 250 pA Max

High Common-Mode Rejection: 114 dB Min

Extended Industrial Temperature Range: -40 $^{\circ}$ C to +85 $^{\circ}$ C

Available In Die Form

GENERAL DESCRIPTION

The OP97 is a low power alternative to the industry-standard OP07 precision amplifier. The OP97 maintains the standards of performance set by the OP07 while utilizing only 600 μ A supply current, less than 1/6 that of an OP07. Offset voltage is an ultralow 25 μ V, and drift over temperature is below 0.6 μ V/ $^{\circ}$ C. External offset trimming is not required in the majority of circuits.

Improvements have been made over OP07 specifications in several areas. Notable is bias current, which remains below 250 pA over the full military temperature range. The OP97 is ideal for use in precision long-term integrators or sample-and-hold circuits that must operate at elevated temperatures.

Common-mode rejection and power supply rejection are also improved with the OP97, at 114 dB minimum over wider ranges of common-mode or supply voltage. Outstanding PSR, a supply range specified from ± 2.25 V to ± 20 V and the OP97's minimal power requirements combine to make the OP97 a preferred device for portable and battery-powered instruments.

The OP97 conforms to the OP07 pinout, with the null potentiometer connected between Pins 1 and 8 with the wiper to V+.

The OP97 will upgrade circuit designs using 725, OP05, OP07, OP12, and 1012 type amplifiers. It may replace 741-type amplifiers in circuits without nulling or where the nulling circuitry has been removed.

PIN CONNECTIONS

Epoxy Mini-DIP (P Suffix)

8-Pin Cerdip

(Z Suffix)

8-Pin SO (S Suffix)

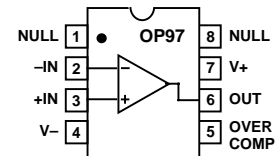

TO-99 (J Suffix)

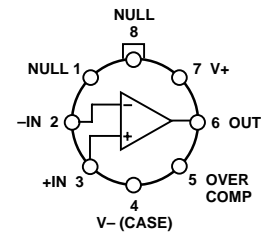

OP97ARC/883 LCC

(RC Suffix)

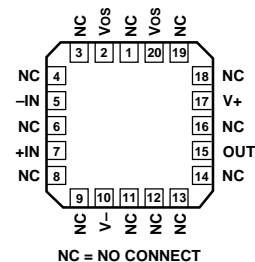

REV. D

Information furnished by Analog Devices is believed to be accurate and reliable. However, no responsibility is assumed by Analog Devices for its use, nor for any infringements of patents or other rights of third parties that may result from its use. No license is granted by implication or otherwise under any patent or patent rights of Analog Devices.

OP97—SPECIFICATIONS

ELECTRICAL CHARACTERISTICS (@ $V_S = \pm 15\text{ V}$, $V_{CM} = 0\text{ V}$, $T_A = 25^\circ\text{C}$, unless otherwise noted.)

Parameter	Symbol	Conditions	OP97A/E			OP97F			Unit
			Min	Typ	Max	Min	Typ	Max	
Input Offset Voltage	V_{OS}			10	25		30	75	μV
Long-Term Offset Voltage Stability	$\Delta V_{OS}/\text{Time}$			0.3			0.3		$\mu\text{V}/\text{Month}$
Input Offset Current	I_{OS}			30	100		30	150	pA
Input Bias Current	I_B			± 30	± 100		± 30	± 150	pA
Input Noise Voltage	e_n p-p	0.1 Hz to 10 Hz		0.5			0.5		μV p-p
Input Noise Voltage Density	e_n	$f_O = 10\text{ Hz}^2$		17	30		17	30	$\text{nV}/\sqrt{\text{Hz}}$
		$f_O = 1000\text{ Hz}^3$		14	22		14	22	$\text{nV}/\sqrt{\text{Hz}}$
Input Noise Current Density	i_n	$f_O = 10\text{ Hz}$		20			20		$\text{fA}/\sqrt{\text{Hz}}$
Large-Signal Voltage Gain	A_{VO}	$V_O = \pm 10\text{ V}$; $R_L = 2\text{ k}\Omega$	300	2000		200	2000		V/mV
Common-Mode Rejection	CMR	$V_{CM} = \pm 13.5\text{ V}$	114	132		110	132		dB
Power-Supply Rejection	PSR	$V_S = \pm 2\text{ V}$ to $\pm 20\text{ V}$	114	132		110	132		dB
Input Voltage Range	IVR	(Note 1)	± 13.5	± 14.0		± 13.5	± 14.0		V
Output Voltage Swing	V_O	$R_L = 10\text{ k}\Omega$	± 13	± 14		± 13	± 14		V
Slew Rate	SR		0.1	0.2		0.1	0.2		V/ μs
Differential Input Resistance	R_{IN}	(Note 4)	30			30			M Ω
Closed-Loop Bandwidth	BW	$A_{VCL} = +1$	0.4	0.9		0.4	0.9		MHz
Supply Current	I_{SY}			380	600		380	600	μA
Supply Voltage	V_S	Operating Range	± 2	± 15	± 20	± 2	± 15	± 20	V

NOTES

¹Guaranteed by CMR test.

²10 Hz noise voltage density is sample tested. Devices 100% tested for noise are available on request.

³Sample tested.

⁴Guaranteed by design.

Specifications subject to change without notice.

ELECTRICAL CHARACTERISTICS (@ $V_S = \pm 15\text{ V}$, $V_{CM} = 0\text{ V}$, $-40^\circ\text{C} \leq T_A \leq +85^\circ\text{C}$ for the OP97E/F and $-55^\circ\text{C} \leq T_A \leq +125^\circ\text{C}$ for the OP97A, unless otherwise noted.)

Parameter	Symbol	Conditions	OP97A/E			OP97F			Unit
			Min	Typ	Max	Min	Typ	Max	
Input Offset Voltage	V_{OS}			25	60		60	200	μV
Average Temperature Coefficient of V_{OS}	TCV_{OS}	S-Package		0.2	0.6		0.3	2.0	$\mu\text{V}/^\circ\text{C}$
Input Offset Current	I_{OS}			60	250		80	750	pA
Average Temperature Coefficient of I_{OS}	TCI_{OS}			0.4	2.5		0.6	7.5	$\text{pA}/^\circ\text{C}$
Input Bias Current	I_B			± 60	± 250		± 80	± 750	pA
Average Temperature Coefficient of I_B	TCI_B			0.4	2.5		0.6	7.5	$\text{pA}/^\circ\text{C}$
Large Signal Voltage Gain	A_{VO}	$V_O = +10\text{ V}$; $R_L = 2\text{ k}\Omega$	200	1000		150	1000		V/mV
Common-Mode Rejection	CMR	$V_{CM} = \pm 13.5\text{ V}$	108	128		108	128		dB
Power Supply Rejection	PSR	$V_S = \pm 2.5\text{ V}$ to $\pm 20\text{ V}$	108	126		108	128		dB
Input Voltage Range	IVR	(Note 1)	± 13.5	± 14.0		± 13.5	± 14.0		V
Output Voltage Swing	V_O	$R_L = 10\text{ k}\Omega$	± 13	± 14		± 13	± 14		V
Slew Rate	SR		0.05	0.15		0.05	0.15		V/ μs
Supply Current	I_{SY}			400	800		400	800	μA
Supply Voltage	V_S	Operating Range	± 2.5	± 15	± 20	± 2.5	± 15	± 20	V

NOTES

¹Guaranteed by CMR test.

Specifications subject to change without notice.

ABSOLUTE MAXIMUM RATINGS¹

Supply Voltage	±20 V
Input Voltage ²	±20 V
Differential Input Voltage ³	±1 V
Differential Input Current ³	±10 mA
Output Short-Circuit Duration	Indefinite
Operating Temperature Range	
OP97A (J, Z, RC)	-55°C to +125°C
OP97E, F (J, P, Z, S)	-40°C to +85°C
Storage Temperature Range	-65°C to +150°C
Junction Temperature Range	-65°C to +150°C
Lead Temperature (Soldering, 60 sec)	300°C

Package Type	θ_{JA} ⁴	θ_{JC}	Unit
TO-99 (J)	150	18	°C/W
8-Lead Hermetic DIP (Z)	148	16	°C/W
8-Lead Plastic DIP (P)	103	43	°C/W
8-Lead SO (S)	158	43	°C/W
20-Contact LCC (RC)	98	98	°C/W

NOTES

¹Absolute maximum ratings apply to both DICE and packaged parts, unless otherwise noted.

²For supply voltages less than ±20 V, the absolute maximum input voltage is equal to the supply voltage.

³The OP97's inputs are protected by back-to-back diodes. Current-limiting resistors are not used in order to achieve low noise. Differential input voltages greater than 1 V will cause excessive current to flow through the input protection diodes unless limiting resistance is used.

⁴ θ_{JA} is specified for worst case mounting conditions, i.e., θ_{JA} is specified for device in socket for TO, cerdip, and P-DIP packages; θ_{JA} is specified for device soldered to printed circuit board for SO package.

ORDERING GUIDE

Model	Temperature Range	Package Option ¹
OP97AZ	-55°C to +125°C	8-Pin Cerdip
OP97ARC/883 ²	-55°C to +125°C	20-Contact LCC
OP97EJ	-40°C to +85°C	TO-99
OP97EZ	-40°C to +85°C	8-Pin Cerdip
OP97EP	-40°C to +85°C	8-Pin Plastic DIP
OP97FJ	-40°C to +85°C	TO-99
OP97FZ	-40°C to +85°C	8-Pin Cerdip
OP97FP	-40°C to +85°C	8-Pin Plastic DIP
OP97FS	-40°C to +85°C	8-Pin SOIC
OP97FS-REEL	-40°C to +85°C	8-Pin SOIC
OP97FS-REEL7	-40°C to +85°C	8-Pin SOIC

NOTES

¹For outline information see Package Information section.

²For devices processed in total compliance to MIL-STD-883, add /883 after part number. Consult factory for /883 data sheet.

CAUTION

ESD (electrostatic discharge) sensitive device. Electrostatic charges as high as 4000 V readily accumulate on the human body and test equipment and can discharge without detection. Although the OP97 features proprietary ESD protection circuitry, permanent damage may occur on devices subjected to high-energy electrostatic discharges. Therefore, proper ESD precautions are recommended to avoid performance degradation or loss of functionality.



DIE CHARACTERISTICS

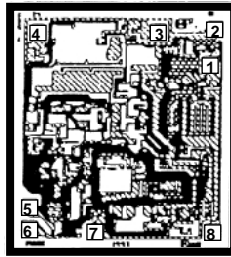

1. OUTPUT
2. +VS
3. OFFSET NULL
4. OFFSET NULL
5. -INPUT
6. +INPUT
7. -VS
8. OVER COMP

DIE SIZE 0.063 × 0.074 INCH, 4,662 SQ. mils
(1.60 × 1.88 mm, 3.01 SQ. mm)

WAFER TEST LIMITS (@ $V_S = \pm 15\text{ V}$, $V_{CM} = 0\text{ V}$, $T_A = 25^\circ\text{C}$, unless otherwise noted.)

Parameter	Symbol	Condition	Limit	Unit
Input Offset Voltage	V_{OS}		250	μV Max
Input Offset Current	I_{OS}		150	pA Max
Input Bias Current	I_B		± 150	pA Max
Large Signal Voltage Gain	A_{VO}	$V_{OUT} = \pm 10\text{ V}$, $R_L = 2\text{ k}\Omega$	120	V/mV Min
Common-Mode Rejection	CMR	$V_{CM} = \pm 13.5$	110	dB Min
Power Supply Rejection	PSR	$V_S = \pm 2\text{ V}$ to $\pm 20\text{ V}$	110	dB Min
Input Voltage Range	IVR	(Note 1)	± 13.5	V Min
Output Voltage Swing	V_O	$R_L = 10\text{ k}\Omega$	± 13	V Min
Slew Rate	SR		0.1	V/ μs Min
Supply Current	I_{SY}	No Load	600	μA Max

NOTES

¹Guaranteed by CMR test.

Electrical tests are performed at wafer probe to the limits shown. Due to variations in assembly methods and normal yield loss, yield after packaging is not guaranteed for standard product dice. Consult factory to negotiate specifications based on dice lot qualification through sample lot assembly and testing.

Typical Performance Characteristics—OP97

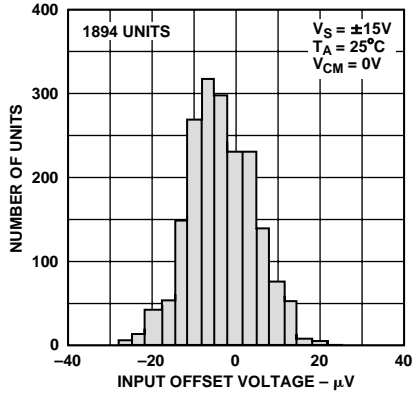

TPC 1. Typical Distribution of Input Offset Voltage

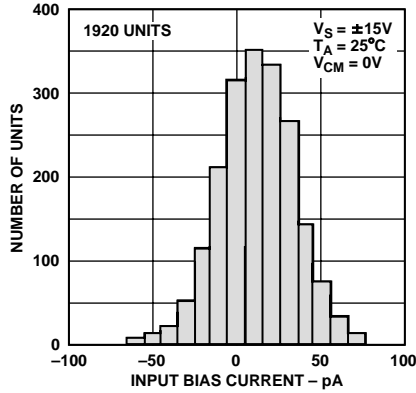

TPC 2. Typical Distribution of Input Bias Current

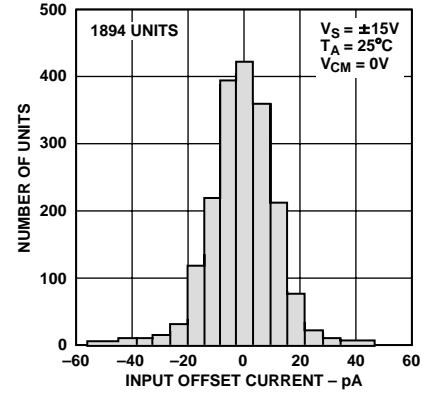

TPC 3. Typical Distribution of Input Offset Current

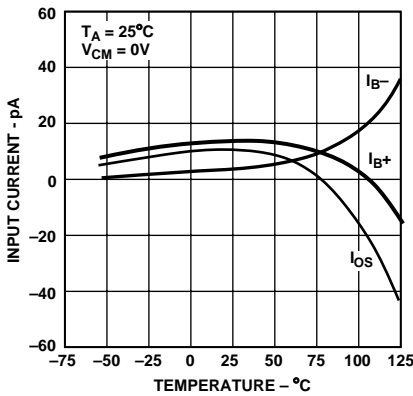

TPC 4. Input Bias, Offset Current vs. Temperature

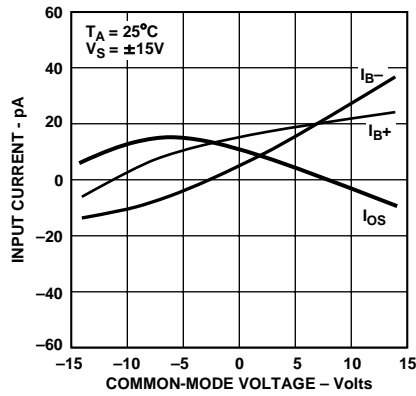

TPC 5. Input Bias, Offset Current vs. Common-Mode Voltage

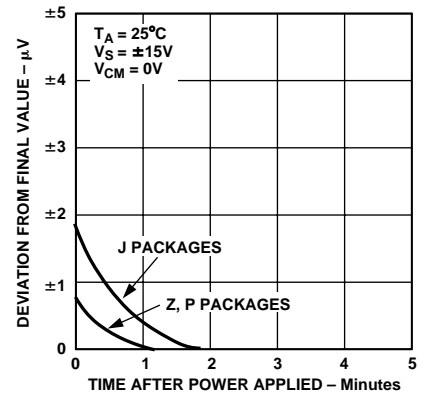

TPC 6. Input Offset Voltage Warm-Up Drift

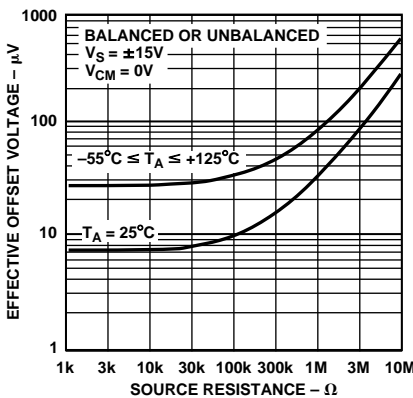

TPC 7. Effective Offset Voltage vs. Source Resistance

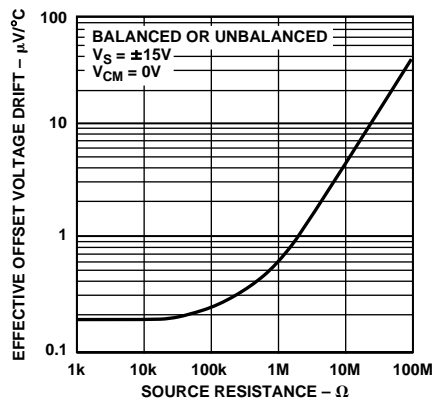

TPC 8. Effective TCV_{OS} vs. Source Resistance

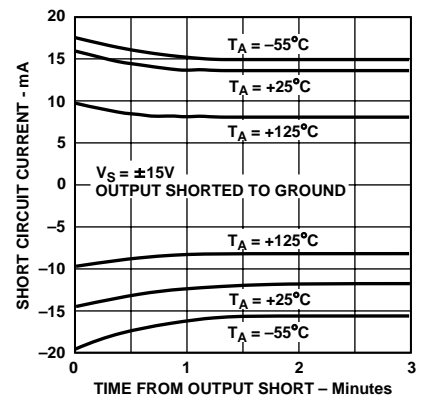

TPC 9. Short Circuit Current vs. Time, Temperature

OP97

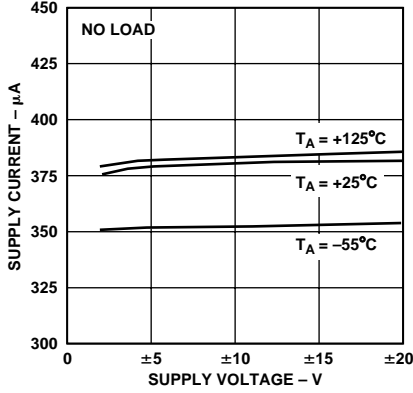

TPC 10. Supply Current vs. Supply Voltage

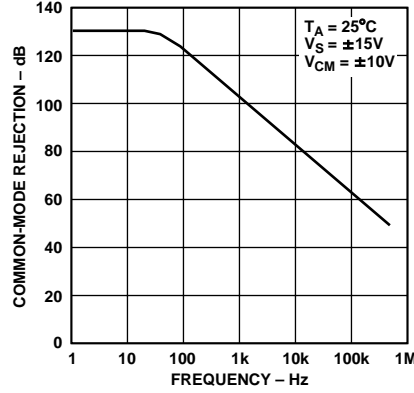

TPC 11. Common-Mode Rejection vs. Frequency

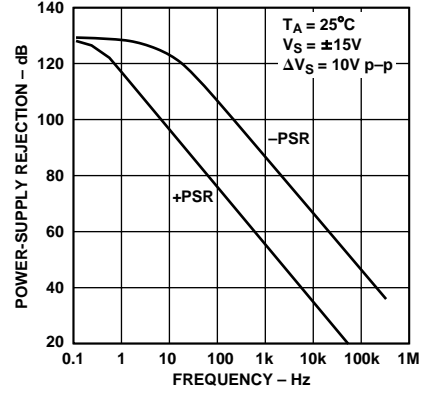

TPC 12. Power-Supply Rejection vs. Frequency

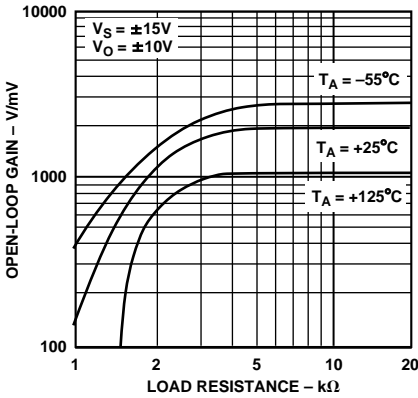

TPC 13. Open-Loop Gain vs. Load Resistance

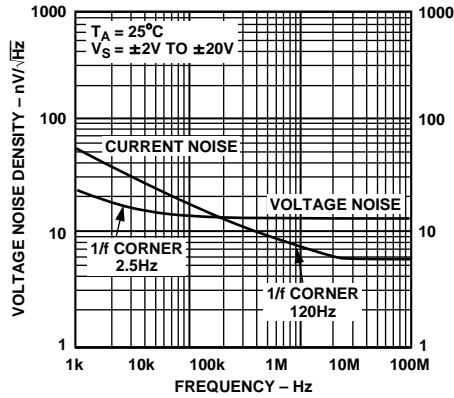

TPC 14. Noise Density vs. Frequency

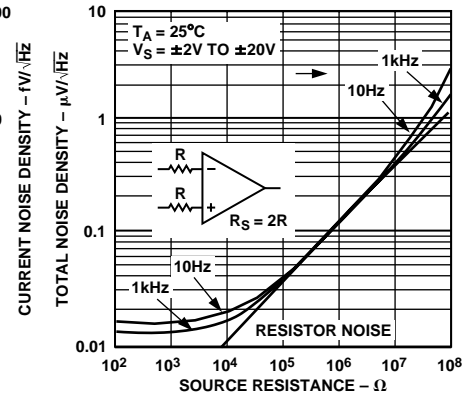

TPC 15. Total Noise Density vs. Source Resistance

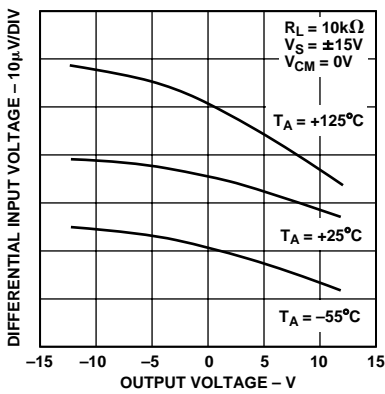
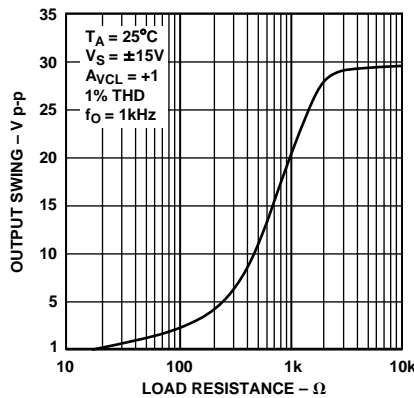
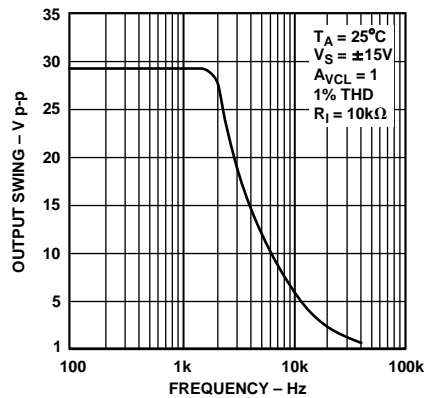

Figure 16. Open-Loop Gain Linearity



TPC 17. Maximum Output Swing vs. Load Resistance



TPC 18. Maximum Output Swing vs. Frequency

Typical Performance Characteristics—OP97

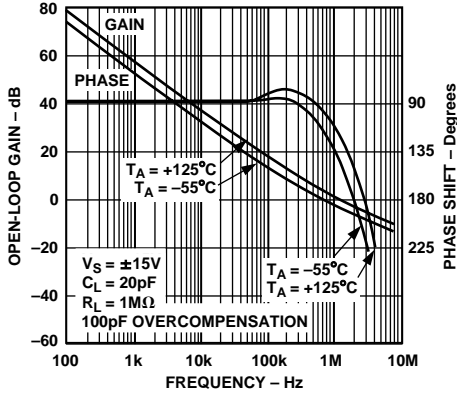

TPC 19. Open-Loop Gain, Phase vs. Frequency ($C_{OC} = 0 \text{ pF}$)

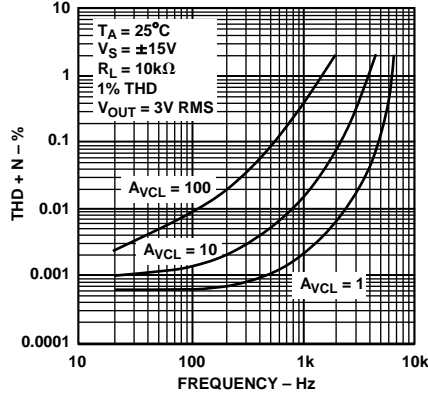

TPC 20. Total Harmonic Distortion Plus Noise vs. Frequency

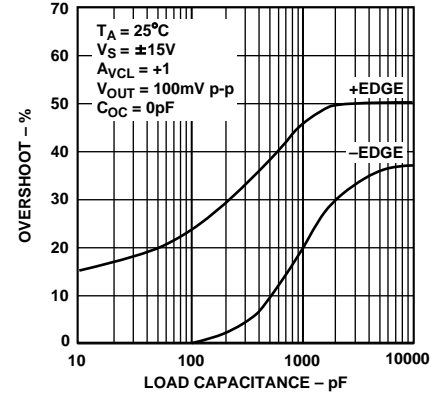

TPC 21. Small Signal Overshoot vs. Capacitive Load

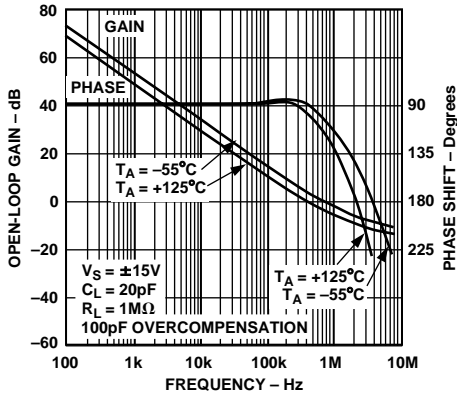

TPC 22. Open-Loop Gain, Phase vs. Frequency ($C_{OC} = 100 \text{ pF}$)

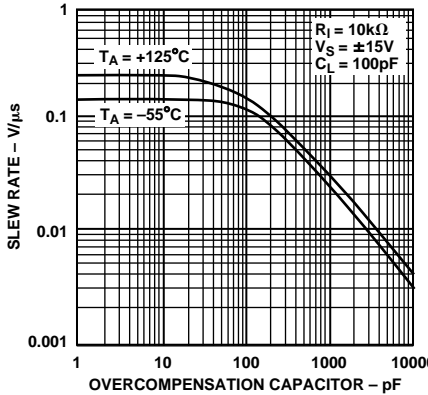

TPC 23. Slew Rate vs. Overcompensation

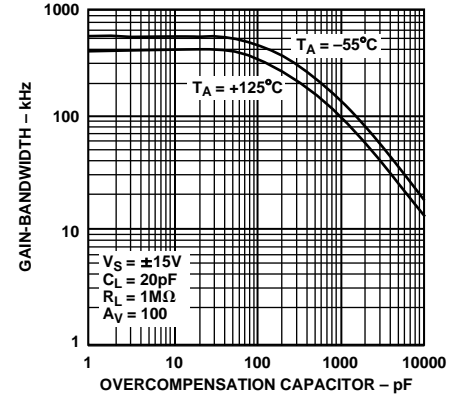

TPC 24. Gain Bandwidth Product vs. Overcompensation

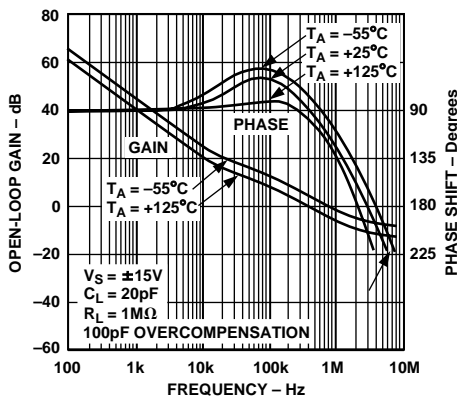

TPC 25. Open-Loop Gain, Phase vs. Frequency ($C_{OC} = 1000 \text{ pF}$)

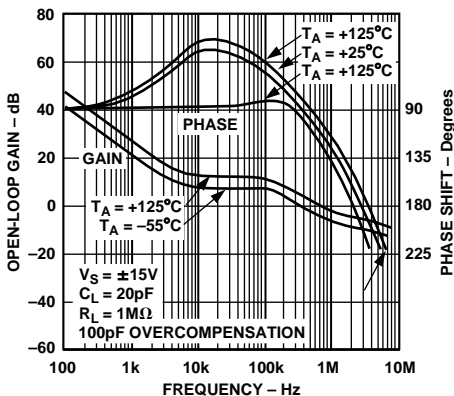

TPC 26. Open-Loop Gain, Phase vs. Frequency ($C_{OC} = 10,000 \text{ pF}$)

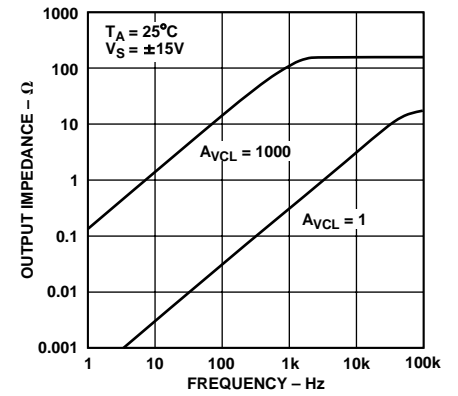

TPC 27. Closed-Loop Output Resistance vs. Frequency

OP97

APPLICATIONS INFORMATION

The OP97 is a low power alternative to the industry standard precision op amp, the OP07. The OP97 may be substituted directly into OP07, OP77, 725, OP05, 112/312, and 1012 sockets with improved performance and/or less power dissipation, and may be inserted into sockets conforming to the 741 pinout if nulling circuitry is not used. Generally, nulling circuitry used with earlier generation amplifiers is rendered superfluous by the OP97's extremely low offset voltage, and may be removed without compromising circuit performance.

Extremely low bias current over the full military temperature range makes the OP97 attractive for use in sample-and-hold amplifiers, peak detectors, and log amplifiers that must operate over a wide temperature range. Balancing input resistances is not necessary with the OP97. Offset voltage and TCV_{OS} are degraded only minimally by high source resistance, even when unbalanced.

The input pins of the OP97 are protected against large differential voltage by back-to-back diodes. Current-limiting resistors are not used so that low noise performance is maintained. If differential voltages above ± 1 V are expected at the inputs, series resistors must be used to limit the current flow to a maximum of 10 mA. Common-mode voltages at the inputs are not restricted, and may vary over the full range of the supply voltages used.

The OP97 requires very little operating headroom about the supply rails, and is specified for operation with supplies as low

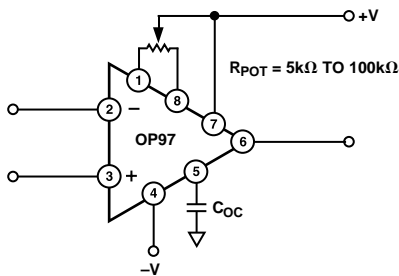

Figure 1. Optional Input Offset Voltage Nulling and Overcompensation Circuits

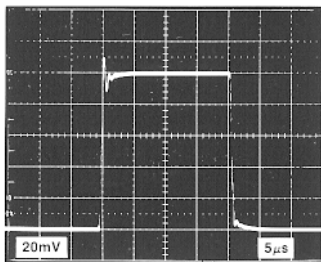

Figure 2. Small-Signal Transient Response ($C_{LOAD} = 100$ pF, $A_{VCL} = 1$)

as ± 2 V. Typically, the common-mode range extends to within one volt of either rail. The output typically swings to within one volt of the rails when using a 10 k Ω load.

Offset nulling is achieved utilizing the same circuitry as an OP07. A potentiometer between 5 k Ω and 100 k Ω is connected between pins 1 and 8 with the wiper connected to the positive supply. The trim range is between 300 μ V and 850 μ V, depending upon the internal trimming of the device.

AC PERFORMANCE

The OP97's ac characteristics are highly stable over its full operating temperature range. Unity-gain small-signal response is shown in Figure 2. Extremely tolerant of capacitive loading on the output, the OP97 displays excellent response even with 1000 pF loads (Figure 3). In large-signal applications, the input protection diodes effectively short the input to the output during the transients if the amplifier is connected in the usual unity-gain configuration. The output enters short-circuit current limit, with the flow going through the protection diodes. Improved large-signal transient response is obtained by using a feedback resistor between the output and the inverting input. Figure 4 shows the large-signal response of the OP97 in unity gain with a 10 k Ω feedback resistor. The unity gain follower circuit is shown in Figure 5.

The overcompensation pin may be used to increase the phase margin of the OP97, or to decrease gain-bandwidth product at gains greater than 10.

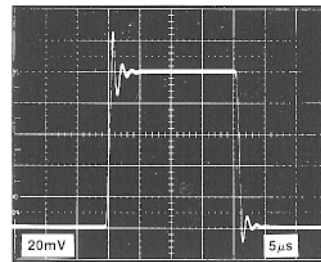

Figure 3. Small-Signal Transient Response ($C_{LOAD} = 1000$ pF, $A_{VCL} = 1$)

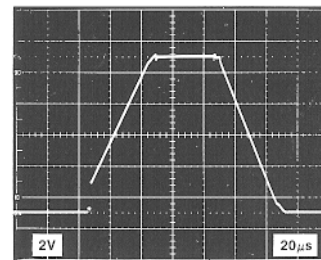

Figure 4. Large-Signal Transient Response ($A_{VCL} = 1$)

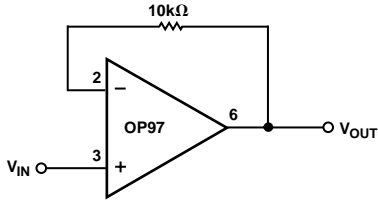

Figure 5. Unity-Gain Follower

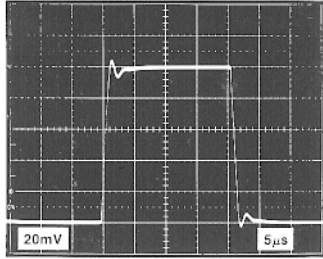

Figure 6. Small-Signal Transient Response with Overcompensation ($C_{LOAD} = 1000 \text{ pF}$, $A_{VCL} = 1$, $C_{OC} = 220 \text{ pF}$)

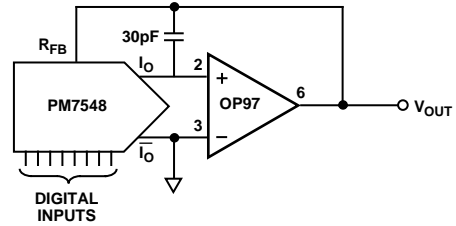

Figure 7. DAC Output Amplifier

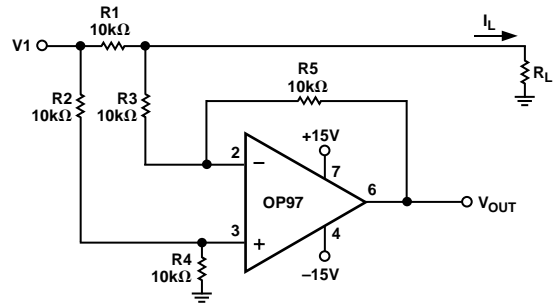

Figure 8. Current Monitor

GUARDING AND SHIELDING

To maintain the extremely high input impedances of the OP97, care must be taken in circuit board layout and manufacturing. Board surfaces must be kept scrupulously clean and free of moisture. Conformal coating is recommended to provide a humidity barrier. Even a clean PC board can have 100 pA of leakage currents between adjacent traces, so that guard rings should be used around the inputs. Guard traces are operated at a voltage close to that on the inputs, so that leakage currents become minimal. In noninverting applications, the guard ring should be connected to the common-mode voltage at the inverting input (Pin 2). In inverting applications, both inputs remain at ground, so that the guard trace should be grounded. Guard traces should be made on both sides of the circuit board.

High impedance circuitry is extremely susceptible to RF pickup, line frequency hum, and radiated noise from switching power supplies. Enclosing sensitive analog sections within grounded shields is generally necessary to prevent excessive noise pickup. Twisted-pair cable will aid in rejection of line frequency hum.

The OP97 is an excellent choice as an output amplifier for higher resolution CMOS DACs. Its tightly trimmed offset voltage and minimal bias current result in virtually no degradation of linearity, even over wide temperature ranges.

Figure 8 shows a versatile monitor circuit that can typically sense current at any point between the $\pm 15 \text{ V}$ supplies. This makes it ideal for sensing current in applications such as full bridge drivers where bidirectional current is associated with large common-mode voltage changes. The 114 dB CMRR of the OP97 makes the amplifier's contribution to common-mode error negligible, leaving only the error due to the resistor ratio inequality. Ideally, $R2/R4 = R3/R5$. This is best trimmed via R4

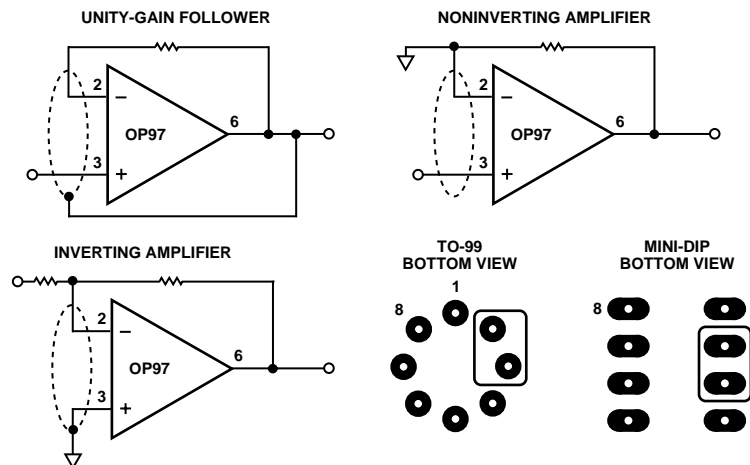

Figure 9. Guard Ring Layout and Connections

OP97

The digitally programmable gain amplifier shown in Figure 10 has 12-bit gain resolution with 10-bit gain linearity over the range of -1 to -1024. The low bias current of the OP97 maintains this linearity, while C1 limits the noise voltage bandwidth allowing accurate measurement down to microvolt levels.

DIGITAL IN	GAIN (Av)
4095	-1.00024
2048	-2
1024	-4
512	-8
256	-16
128	-32
64	-64
32	-128
16	-256
8	-512
4	-1024
2	-2048
1	-4096
0	OPEN LOOP

Many high-speed amplifiers suffer from less-than-perfect low-frequency performance. A combination amplifier consisting of a high precision, slow device like the OP97 and a faster device such as the OP44 results in uniformly accurate performance from dc to the high frequency limit of the OP44, which has a gain-bandwidth product of 23 MHz. The circuit shown in Figure 11 accomplishes this, with the OP44 providing high frequency amplification and the OP97 operating on low frequency signals and providing offset correction. Offset voltage and drift of the circuit are controlled by the OP97.

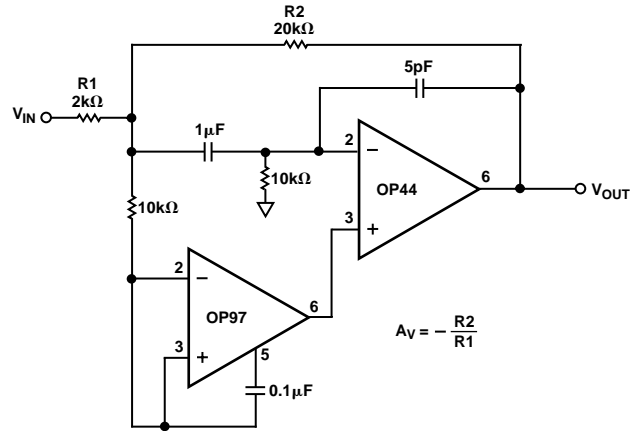

Figure 11. Combination High-Speed, Precision Amplifier

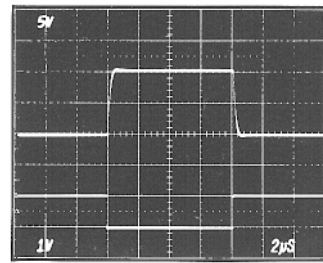

Figure 12. Combination Amplifier Transient Response

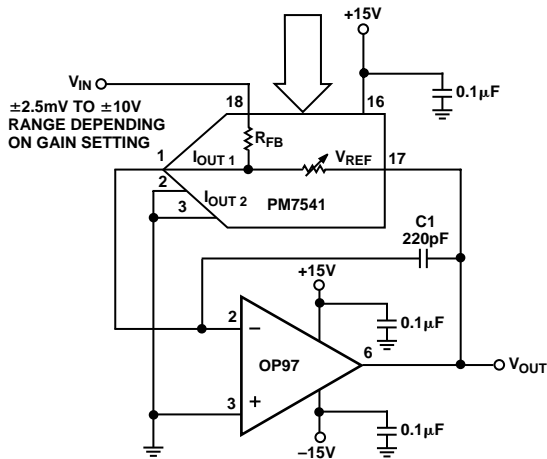
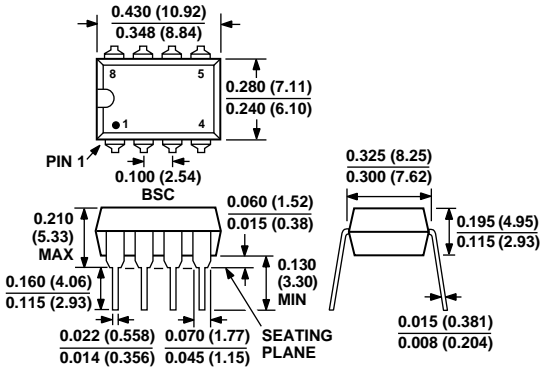

Figure 10. Precision Programmable Gain Amplifier

OUTLINE DIMENSIONS

Dimensions shown in inches and (mm).

8-Lead Plastic DIP
(N-8)



8-Lead Metal Can
(H-08A)

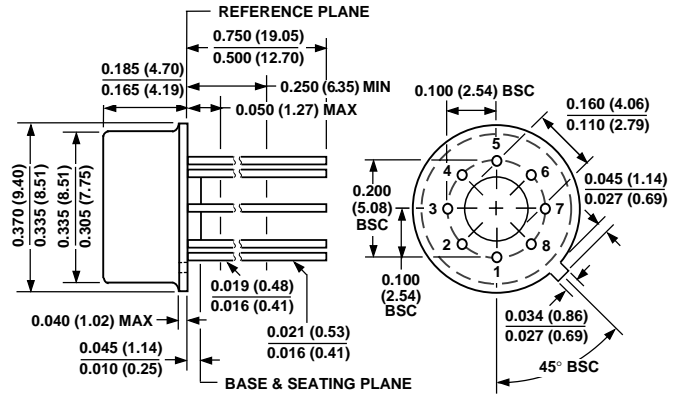

8-Pin Hermetic DIP
(Q-8)

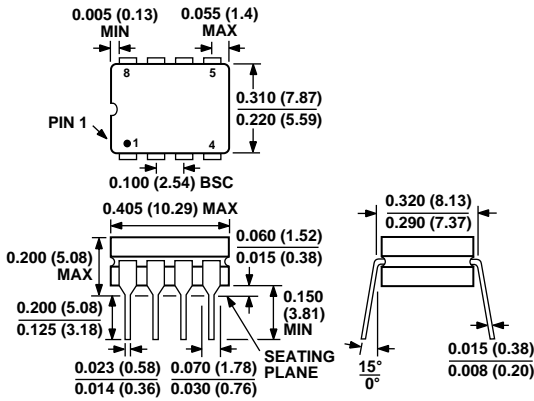

20-Terminal Ceramic Leadless Chip Carrier (CLCC)
(E-20A)

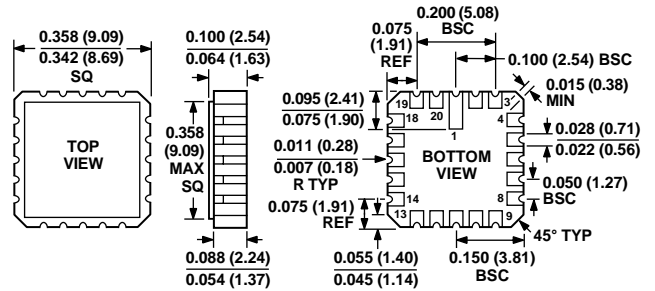

8-Pin SOIC
(SO-8)

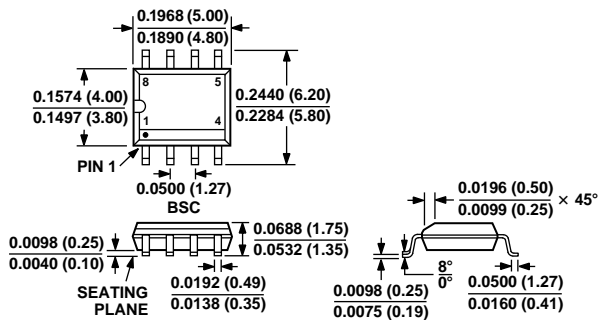

OP97

C00299-0-1/02(D)

PRINTED IN U.S.A.