

Schottky Barrier Diodes 30V

V _{RM} (V)	Package	Part Number	I _F (AV) (A)	I _{FSM} (A)	T _J (°C)	T _{stg} (°C)	V _F (V) max	I _F (A)	I _R (mA)	I _R (H) (mA)	R _{th} (j-ℓ) R _{th} (j-c) (°C/W)	Mass (g)	Fig. No.	Page where characteristic curve is shown		
				50Hz Half-cycle Sinewave Single Shot					V _R =V _{RM} max	V _R =V _{RM} max					T _a (°C)	
30	Surface Mount	MI1A3	1.0	12	-40 to +150	0.47	1.0	1	70	150 (Tj)	70	0.011	1	82		
		MI2A3 *	1.0	12	-40 to +125	0.39	1.0	2	110	125 (Tj)	70	0.011				
		SFPA-53	1.0	30	-40 to +125	0.36	1.0	1.5	70	100	20	0.072			2	—
		SFPJ-53 *	1.0	30	-40 to +150	0.45	1.0	1.0	35	150	20	0.072				
		SFPA-63	2.0	40	-40 to +125	0.36	2.0	3.0	140	100	20	0.072				
		SFPE-63 *	2.0	40	-40 to +150	0.55	2.0	0.2	20	150 (Tj)	20	0.072				
		SFPJ-63	2.0	40	-40 to +150	0.45	2.0	2.0	70	150	20	0.072				
		SFPA-73	3.0	50	-40 to +125	0.36	3.0	4.5	210	100	20	0.072				
		SFPJ-73	3.0	50	-40 to +150	0.45	3.0	3.0	100	150	20	0.072				
		SPJ-G53S	5.0	100	-40 to +150	0.45	5.0	5.0	250	150	5	0.29				
	Surface Mount Center-tap	SPJ-63S	6.0	50	-40 to +150	0.45	3.0	3	100	150 (Tj)	5	0.29	3	—		
	Axial	AK 03	1.0	25	-40 to +150	0.55	1.0	1	50	100 (Tj)	22	0.13	4	85		
		EA 03	1.0	30	-40 to +125	0.36	1.0	1.5	70	100	20	0.3	5	—		
		EK 03	1.0	40	-40 to +150	0.55	1.0	5	50	100	20	0.3	6	86		
		EK 13	1.5	40	-40 to +150	0.55	2.0	5	50	100	17	0.3	6	—		
		RK 13	1.7	60	-40 to +150	0.55	2.0	5	50	100	15	0.45	7	87		
		RA 13	2.0	40	-40 to +125	0.36	2.0	3	140	100	15	0.45	7	—		
		RK 33	2.5	50	-40 to +150	0.55	2.5	5	50	100	12	0.6	8	87		
		RJ 43	3.0	50	-40 to +150	0.45	3.0	3	100	150	8	1.2	9	—		
		RK 43	3.0	80	-40 to +150	0.55	3.0	5	50	100	8	1.2	9	88		
Center-tap		FMJ-23L	10	100	-40 to +150	0.45	5.0	5	250	150 (Tj)	4	2.1	10	93		
	FMJ-2203	20	150	-40 to +150	0.47	10.0	10	350	150	4	2.1	10	—			
	FMJ-2303	30	150	-40 to +150	0.48	15.0	15	500	150	4	2.1	10	—			

External Dimensions

Flammability: UL94V-0 or Equivalent (Unit: mm)

* : Under development

1

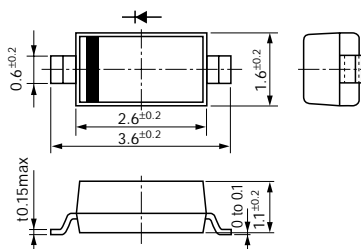

2

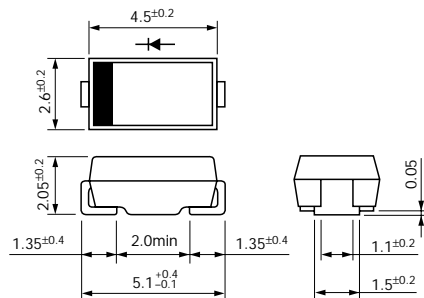

3

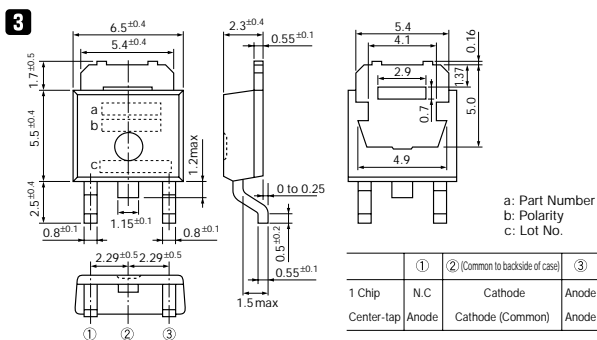

4

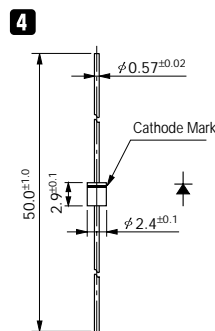

5

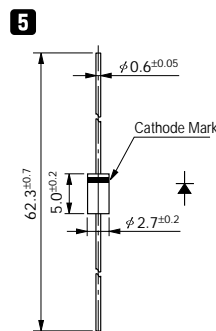

6

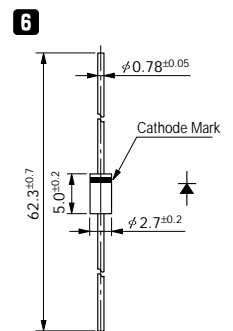

7

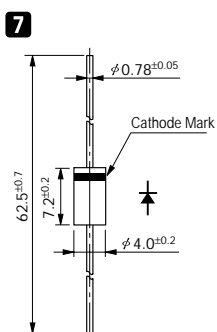

8

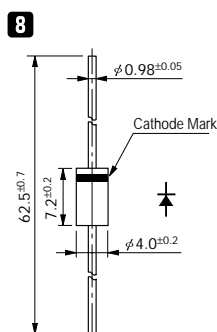

9

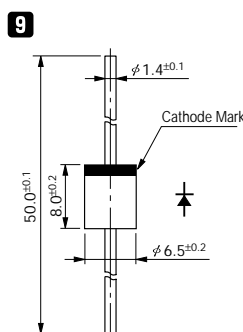

10

