

**OPA237**  
**OPA2237**  
**OPA4237**

# SINGLE-SUPPLY OPERATIONAL AMPLIFIERS

## *MicroAmplifier™* Series

### FEATURES

- MICRO-SIZE, MINIATURE PACKAGES  
 Single: SOT-23-5, SO-8  
 Dual: MSOP-8, SO-8  
 Quad: SSOP-16
- LOW OFFSET VOLTAGE: 750 $\mu$ V max
- WIDE SUPPLY RANGE  
 Single Supply: +2.7V to +36V  
 Dual Supply:  $\pm$ 1.35V to  $\pm$ 18V
- LOW QUIESCENT CURRENT: 350 $\mu$ A max
- WIDE BANDWIDTH: 1.5MHz

### APPLICATIONS

- BATTERY POWERED INSTRUMENTS
- PORTABLE DEVICES
- PCMCIA CARDS
- MEDICAL INSTRUMENTS
- TEST EQUIPMENT

### DESCRIPTION

The OPA237 op amp family is one of Burr-Brown's *MicroAmplifier™* series of miniature products. In addition to small size, these devices feature low offset voltage, low quiescent current, low bias current, and a wide supply range. Single, dual, and quad versions have identical specifications for maximum design flexibility. They are ideal for single supply, battery operated, and space-limited applications, such as PCMCIA cards and other portable instruments.

OPA237 series op amps can operate from either single or dual supplies. When operated from a single supply, the input common-mode range extends below ground and the output can swing to within 10mV of ground. Dual and quad designs feature completely independent circuitry for lowest crosstalk and freedom from interaction.

Single, dual, and quad are offered in space-saving surface-mount packages. The single version is available in the ultra-miniature 5-lead SOT-23-5 and SO-8 surface-mount. The dual version comes in a miniature MSOP-8 and SO-8 surface-mount. The quad is available in an SSOP-16. The SSOP-16 has the same body size as an SO-8 with 16 leads, while the MSOP-8 has the same lead count as a SO-8 but half the size. The SOT-23-5 is even smaller at one-fourth the size of an SO-8. All are specified for  $-40^{\circ}$ C to  $+85^{\circ}$ C operation. A macromodel is available for design analysis.

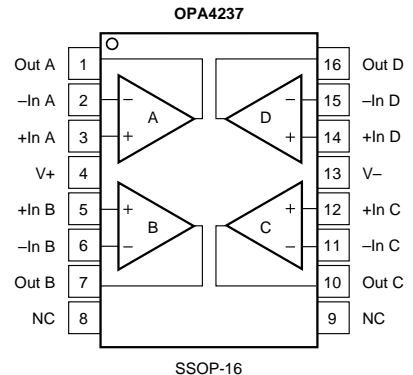
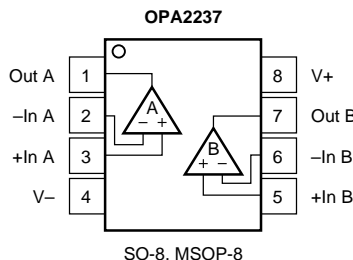
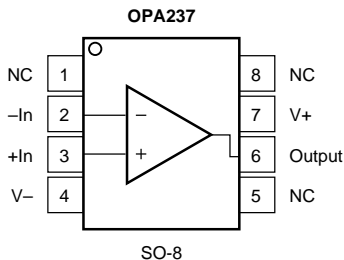
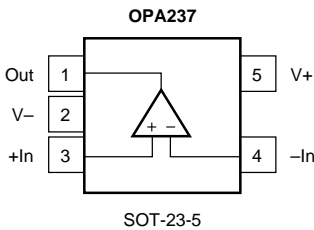

International Airport Industrial Park • Mailing Address: PO Box 11400, Tucson, AZ 85734 • Street Address: 6730 S. Tucson Blvd., Tucson, AZ 85706 • Tel: (520) 746-1111 • Twx: 910-952-1111  
 Internet: <http://www.burr-brown.com/> • FAXLine: (800) 548-6133 (US/Canada Only) • Cable: BURCORP • Telex: 066-6491 • FAX: (520) 889-1510 • Immediate Product Info: (800) 548-6132

# SPECIFICATIONS: $V_S = +5V$

At  $T_A = +25^\circ\text{C}$ ,  $V_S = +5V$ ,  $R_L = 10\text{k}\Omega$  connected to  $V_S/2$ , unless otherwise noted.

PARAMETER	CONDITION	OPA237UA, NA OPA2237UA, EA OPA4237UA			UNITS
		MIN	TYP	MAX	
<b>OFFSET VOLTAGE</b> Input Offset Voltage vs Temperature <sup>(1)</sup> vs Power Supply (PSRR) Channel Separation (dual and quad)	$V_{CM} = 2.5V$ Specified Temperature Range $V_S = +2.7V$ to $+36V$		$\pm 250$ $\pm 2$ 10 0.5	$\pm 750$ $\pm 5$ 30	$\mu V$ $\mu V/^\circ\text{C}$ $\mu V/V$ $\mu V/V$
<b>INPUT BIAS CURRENT</b> Input Bias Current <sup>(2)</sup> Input Offset Current	$V_{CM} = 2.5V$ $V_{CM} = 2.5V$		-10 $\pm 0.5$	-40 $\pm 10$	nA nA
<b>NOISE</b> Input Voltage Noise, $f = 0.1$ to $10\text{Hz}$ Input Voltage Noise Density, $f = 1\text{kHz}$ Current Noise Density, $f = 1\text{kHz}$			1 28 60		$\mu V\text{p-p}$ $\text{nV}/\sqrt{\text{Hz}}$ $\text{fA}/\sqrt{\text{Hz}}$
<b>INPUT VOLTAGE RANGE</b> Common-Mode Voltage Range Common-Mode Rejection	$V_{CM} = -0.2V$ to $3.5V$	-0.2 78	86	(V+) -1.5	V dB
<b>INPUT IMPEDANCE</b> Differential Common-Mode			$5 \cdot 10^6 \parallel 4$ $5 \cdot 10^9 \parallel 2$		$\Omega \parallel \text{pF}$ $\Omega \parallel \text{pF}$
<b>OPEN-LOOP GAIN</b> Open-Loop Voltage Gain	$V_O = 0.5V$ to $4V$	80	88		dB
<b>FREQUENCY RESPONSE</b> Gain-Bandwidth Product Slew Rate Settling Time: 0.1% 0.01%	$G = 1$ $G = -1$ , 3V Step, $C_L = 100\text{pF}$ $G = -1$ , 3V Step, $C_L = 100\text{pF}$		1.4 0.5 11 16		MHz $V/\mu\text{s}$ $\mu\text{s}$ $\mu\text{s}$
<b>OUTPUT</b> Voltage Output, Positive Negative Positive Negative Positive Negative Short-Circuit Current Capacitive Load Drive (stable operation)	$R_L = 100\text{k}\Omega$ to Ground $R_L = 100\text{k}\Omega$ to Ground $R_L = 100\text{k}\Omega$ to $2.5V$ $R_L = 100\text{k}\Omega$ to $2.5V$ $R_L = 10\text{k}\Omega$ to $2.5V$ $R_L = 10\text{k}\Omega$ to $2.5V$	(V+) -1 0.01 (V+) -1 0.12 (V+) -1 0.5	(V+) -0.75 0.001 (V+) -0.75 0.04 (V+) -0.75 0.35		V V V V V V mA See Typical Curves
<b>POWER SUPPLY</b> Specified Operating Voltage Operating Range Quiescent Current (per amplifier)		+2.7	+5 170	+36 350	V V $\mu\text{A}$
<b>TEMPERATURE RANGE</b> Specified Range Operating Range Storage Thermal Resistance, $\theta_{JA}$ 5-Lead SOT-23-5 MSOP-8 Surface-Mount SSOP-16 Surface-Mount SO-8 Surface-Mount		-40 -55 -55		+85 +125 +125	$^\circ\text{C}$ $^\circ\text{C}$ $^\circ\text{C}$ $^\circ\text{C/W}$ $^\circ\text{C/W}$ $^\circ\text{C/W}$ $^\circ\text{C/W}$

NOTES: (1) Guaranteed by wafer-level test to 95% confidence. (2) Positive conventional current flows into the input terminals.

The information provided herein is believed to be reliable; however, BURR-BROWN assumes no responsibility for inaccuracies or omissions. BURR-BROWN assumes no responsibility for the use of this information, and all use of such information shall be entirely at the user's own risk. Prices and specifications are subject to change without notice. No patent rights or licenses to any of the circuits described herein are implied or granted to any third party. BURR-BROWN does not authorize or warrant any BURR-BROWN product for use in life support devices and/or systems.



# SPECIFICATIONS: $V_S = +2.7V$

At  $T_A = +25^\circ C$ ,  $V_S = +2.7V$ ,  $R_L = 10k\Omega$  connected to  $V_S/2$ , unless otherwise noted.

PARAMETER	CONDITION	OPA237UA, NA OPA2237UA, EA OPA4237UA			UNITS
		MIN	TYP	MAX	
<b>OFFSET VOLTAGE</b> Input Offset Voltage vs Temperature <sup>(1)</sup> vs Power Supply (PSRR) Channel Separation (dual and quad)	$V_{CM} = 1V$ Specified Temperature Range $V_S = +2.7V$ to $+36V$		$\pm 250$ $\pm 2$ 10 0.5	$\pm 750$ $\pm 5$ 30	$\mu V$ $\mu V/^\circ C$ $\mu V/V$ $\mu V/V$
<b>INPUT BIAS CURRENT</b> Input Bias Current <sup>(2)</sup> Input Offset Current	$V_{CM} = 1V$ $V_{CM} = 1V$		-10 $\pm 0.5$	-40 $\pm 10$	nA nA
<b>NOISE</b> Input Voltage Noise, $f = 0.1$ to $10Hz$ Input Voltage Noise Density, $f = 1kHz$ Current Noise Density, $f = 1kHz$			1 28 60		$\mu Vp-p$ $nV/\sqrt{Hz}$ $fA/\sqrt{Hz}$
<b>INPUT VOLTAGE RANGE</b> Common-Mode Voltage Range Common-Mode Rejection	$V_{CM} = -0.2V$ to $1.2V$	-0.2 75	85	(V+) -1.5	V dB
<b>INPUT IMPEDANCE</b> Differential Common-Mode			$5 \cdot 10^6 \parallel 4$ $5 \cdot 10^9 \parallel 2$		$\Omega \parallel pF$ $\Omega \parallel pF$
<b>OPEN-LOOP GAIN</b> Open-Loop Voltage Gain	$V_O = 0.5V$ to $1.7V$	80	88		dB
<b>FREQUENCY RESPONSE</b> Gain-Bandwidth Product Slew Rate Settling Time: 0.1% 0.01%	$G = 1$ $G = -1$ , 1V Step, $C_L = 100pF$ $G = -1$ , 1V Step, $C_L = 100pF$		1.2 0.5 5 8		MHz V/ $\mu s$ $\mu s$ $\mu s$
<b>OUTPUT</b> Voltage Output, Positive Negative Positive Negative Positive Negative Short-Circuit Current Capacitive Load Drive (stable operation)	$R_L = 100k\Omega$ to Ground $R_L = 100k\Omega$ to Ground $R_L = 100k\Omega$ to $1.35V$ $R_L = 100k\Omega$ to $1.35V$ $R_L = 10k\Omega$ to $1.35V$ $R_L = 10k\Omega$ to $1.35V$	(V+) -1 0.01 (V+) -1 0.06 (V+) -1 0.3	(V+) -0.75 0.001 (V+) -0.75 0.02 (V+) -0.75 0.2	-5/+3.5	V V V V V V mA
			See Typical Curves		
<b>POWER SUPPLY</b> Specified Operating Voltage Operating Range Quiescent Current (per amplifier)		+2.7	+2.7 160	+36 350	V V $\mu A$
<b>TEMPERATURE RANGE</b> Specified Range Operating Range Storage Thermal Resistance, $\theta_{JA}$ 5-Lead SOT-23-5 MSOP-8 Surface-Mount SSOP-16 Surface-Mount SO-8 Surface-Mount		-40 -55 -55		+85 +125 +125	$^\circ C$ $^\circ C$ $^\circ C$ $^\circ C/W$ $^\circ C/W$ $^\circ C/W$ $^\circ C/W$

NOTES: (1) Guaranteed by wafer-level test to 95% confidence. (2) Positive conventional current flows into the input terminals.

# SPECIFICATIONS: $V_S = \pm 15V$

At  $T_A = +25^\circ C$ ,  $V_S = \pm 15V$ ,  $R_L = 10k\Omega$  connected to  $V_S/2$ , unless otherwise noted.

PARAMETER	CONDITION	OPA237UA, NA OPA2237UA, EA OPA4237UA			UNITS
		MIN	TYP	MAX	
<b>OFFSET VOLTAGE</b> Input Offset Voltage vs Temperature <sup>(1)</sup> vs Power Supply (PSRR) Channel Separation (dual and quad)	$V_{CM} = 0V$ Specified Temperature Range $V_S = \pm 1.35V$ to $\pm 18V$		$\pm 350$ $\pm 2.5$ 10 0.5	$\pm 950$ $\pm 7$ 30	$\mu V$ $\mu V/^\circ C$ $\mu V/V$ $\mu V/V$
<b>INPUT BIAS CURRENT</b> Input Bias Current <sup>(2)</sup> Input Offset Current	$V_{CM} = 0V$ $V_{CM} = 0V$		-8.5 $\pm 0.5$	-40 $\pm 10$	nA nA
<b>NOISE</b> Input Voltage Noise, $f = 0.1$ to $10Hz$ Input Voltage Noise Density, $f = 1kHz$ Current Noise Density, $f = 1kHz$			1 28 60		$\mu Vp-p$ $nV/\sqrt{Hz}$ $fA/\sqrt{Hz}$
<b>INPUT VOLTAGE RANGE</b> Common-Mode Voltage Range Common-Mode Rejection	$V_{CM} = -15V$ to $13.5V$	(V-) -0.2 80	90	(V+) -1.5	V dB
<b>INPUT IMPEDANCE</b> Differential Common-Mode			$5 \cdot 10^6 \parallel 4$ $5 \cdot 10^9 \parallel 2$		$\Omega \parallel pF$ $\Omega \parallel pF$
<b>OPEN-LOOP GAIN</b> Open-Loop Voltage Gain	$V_O = -14V$ to $13.8V$	80	88		dB
<b>FREQUENCY RESPONSE</b> Gain-Bandwidth Product Slew Rate Settling Time: 0.1% 0.01%	$G = 1$ $G = -1$ , 10V Step, $C_L = 100pF$ $G = -1$ , 10V Step, $C_L = 100pF$		1.5 0.5 18 21		MHz V/ $\mu s$ $\mu s$ $\mu s$
<b>OUTPUT</b> Voltage Output, Positive Negative Positive Negative Short-Circuit Current Capacitive Load Drive (stable operation)	$R_L = 100k\Omega$ $R_L = 100k\Omega$ $R_L = 10k\Omega$ $R_L = 10k\Omega$	(V+) -1.2 (V-) +0.5 (V+) -1.2 (V-) +1	(V+) -0.9 (V-) +0.3 (V+) -0.9 (V-) +0.85 -8/+4.5		V V V V mA See Typical Curves
<b>POWER SUPPLY</b> Specified Operating Voltage Operating Range Quiescent Current (per amplifier)		$\pm 1.35$	$\pm 15$ $\pm 200$	$\pm 18$ $\pm 475$	V V $\mu A$
<b>TEMPERATURE RANGE</b> Specified Range Operating Range Storage Thermal Resistance, $\theta_{JA}$ 5-Lead SOT-23-5 MSOP-8 Surface-Mount SSOP-16 Surface-Mount SO-8 Surface-Mount		-40 -55 -55		+85 +125 +125	$^\circ C$ $^\circ C$ $^\circ C$ $^\circ C/W$ $^\circ C/W$ $^\circ C/W$ $^\circ C/W$

NOTES: (1) Guaranteed by wafer-level test to 95% confidence. (2) Positive conventional current flows into the input terminals.

## ABSOLUTE MAXIMUM RATINGS

Supply Voltage, V+ to V- .....	36V
Input Voltage .....	(V-) -0.7V to (V+) +0.7V
Output Short-Circuit <sup>(1)</sup> .....	Continuous
Operating Temperature .....	-40°C to +125°C
Storage Temperature .....	-55°C to +125°C
Junction Temperature .....	+150°C
Lead Temperature (soldering, 10s) .....	300°C

NOTE: (1) Short circuit to ground, one amplifier per package.



## ELECTROSTATIC DISCHARGE SENSITIVITY

This integrated circuit can be damaged by ESD. Burr-Brown recommends that all integrated circuits be handled with appropriate precautions. Failure to observe proper handling and installation procedures can cause damage.

ESD damage can range from subtle performance degradation to complete device failure. Precision integrated circuits may be more susceptible to damage because very small parametric changes could cause the device not to meet its published specifications.

## PACKAGE/ORDERING INFORMATION

PRODUCT	PACKAGE	PACKAGE DRAWING NUMBER <sup>(1)</sup>	TEMPERATURE RANGE	PACKAGE MARKING	ORDERING NUMBER <sup>(2)</sup>
<b>Single</b>					
OPA237NA	5-Lead SOT-23-5	331	-40°C to +85°C	A37A	OPA237NA-250
"	"	"	"	"	OPA237NA-3K
OPA237UA	SO-8 Surface-Mount	182	-40°C to +85°C	OPA237UA	OPA237UA
<b>Dual</b>					
OPA2237EA	MSOP-8 Surface-Mount	337	-40°C to +85°C	B37A	OPA2237EA-250
"	"	"	"	"	OPA2237EA-2500
OPA2237UA	SO-8 Surface-Mount	182	-40°C to +85°C	OPA2237UA	OPA2237UA
<b>Quad</b>					
OPA4237UA	SSOP-16 Surface-Mount	322	-40°C to +85°C	OPA4237UA	OPA4237UA-250
"	"	"	"	"	OPA4237UA-2500

NOTE: (1) For detailed drawing and dimension table, please see end of data sheet, or Appendix C of Burr-Brown IC Data Book. (2) Models with -250, -2500, and -3K are available only in Tape and Reel in the quantity indicated (e.g., -250 indicates 250 devices per reel). Ordering 3000 pieces of "OPA237NA-3K" will get a single 3000 piece Tape and Reel. SO-8 models are available in tubes or Tape and Reel. For detailed Tape and Reel mechanical information, refer to Appendix B of Burr-Brown IC Data Book.

# TYPICAL PERFORMANCE CURVES

At  $T_A = +25^\circ\text{C}$  and  $R_L = 10\text{k}\Omega$ , unless otherwise noted.

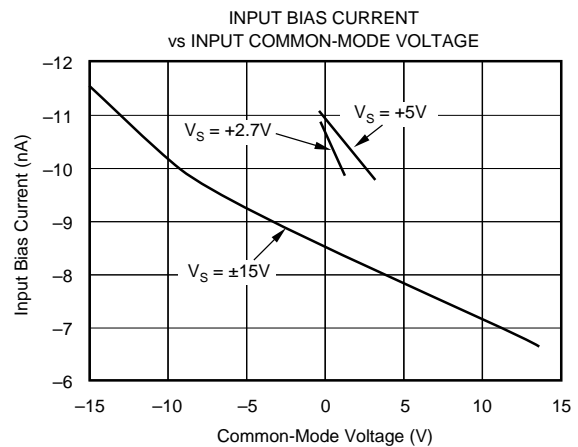
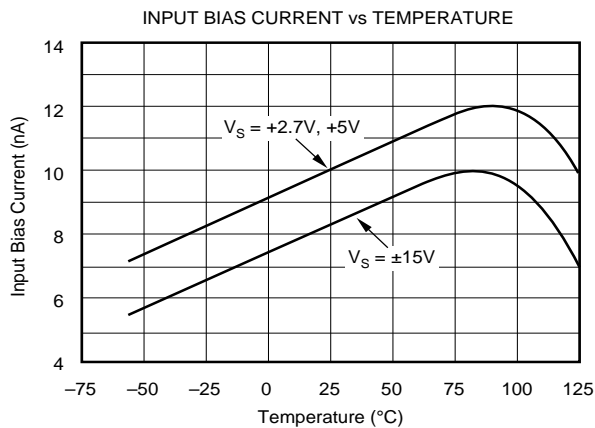
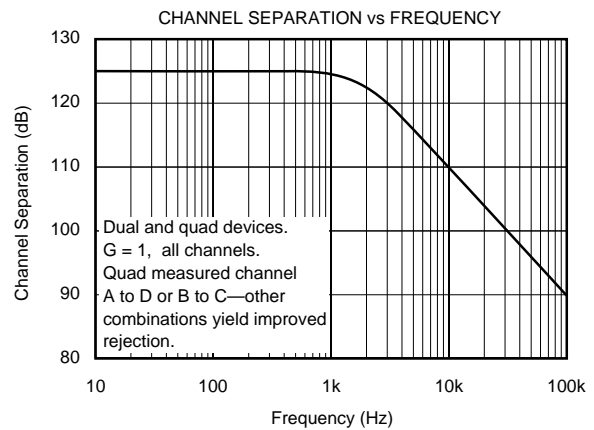
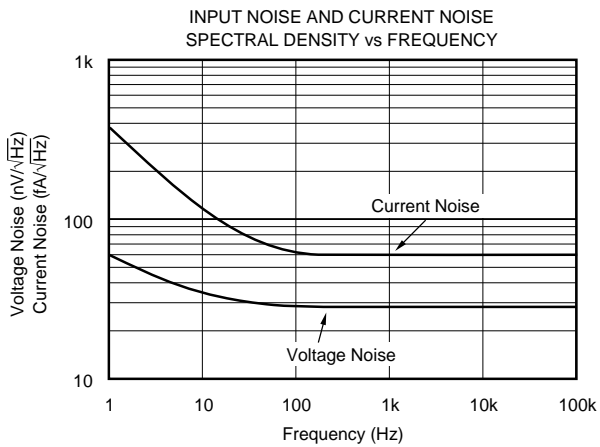
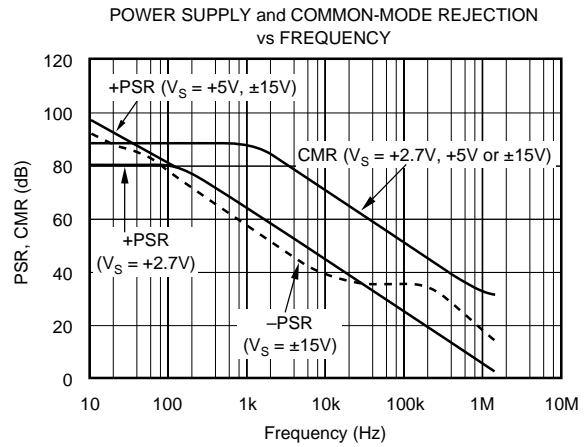
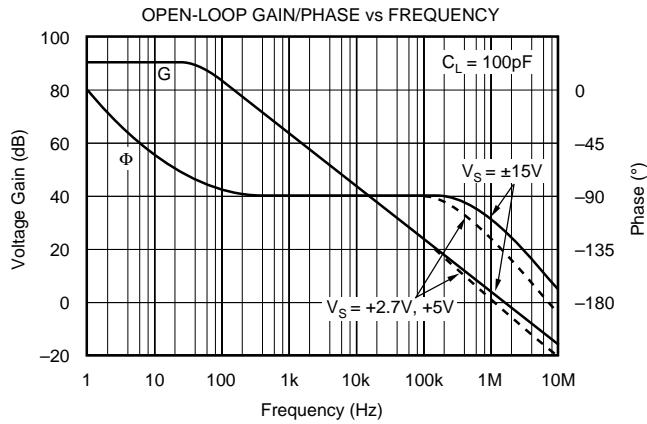

# TYPICAL PERFORMANCE CURVES (CONT)

At  $T_A = +25^\circ\text{C}$  and  $R_L = 10\text{k}\Omega$ , unless otherwise noted.

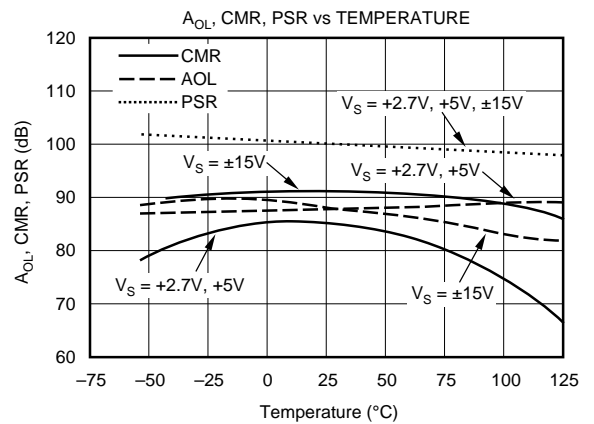
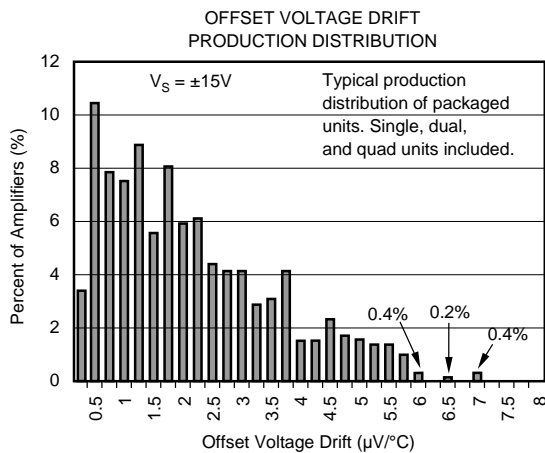
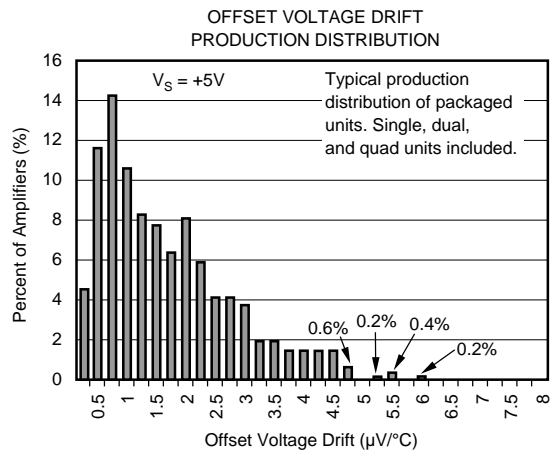
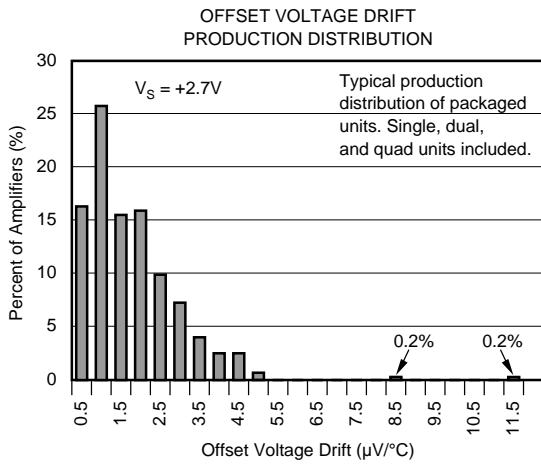
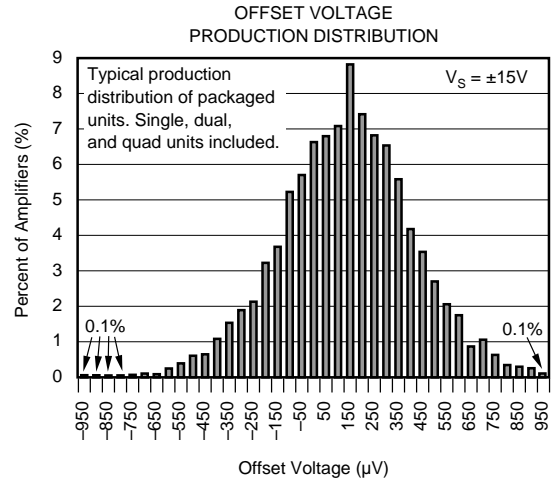
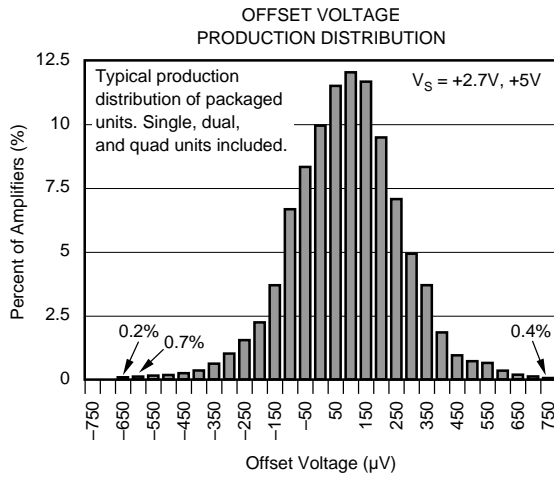

# TYPICAL PERFORMANCE CURVES (CONT)

At  $T_A = +25^\circ\text{C}$  and  $R_L = 10\text{k}\Omega$ , unless otherwise noted.

SMALL-SIGNAL STEP RESPONSE  
 $G = 1$ ,  $C_L = 100\text{pF}$ ,  $V_S = +5\text{V}$

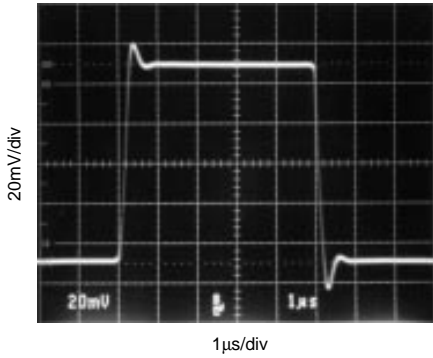

SMALL-SIGNAL STEP RESPONSE  
 $G = 1$ ,  $C_L = 220\text{pF}$ ,  $V_S = +5\text{V}$

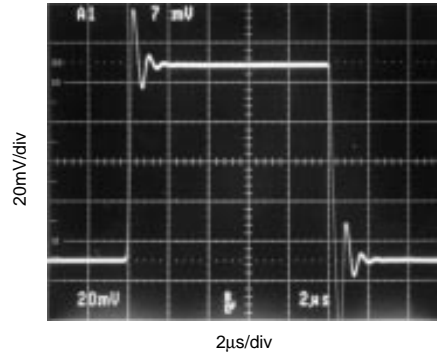

LARGE-SIGNAL STEP RESPONSE  
 $G = 1$ ,  $C_L = 100\text{pF}$ ,  $V_S = +5\text{V}$

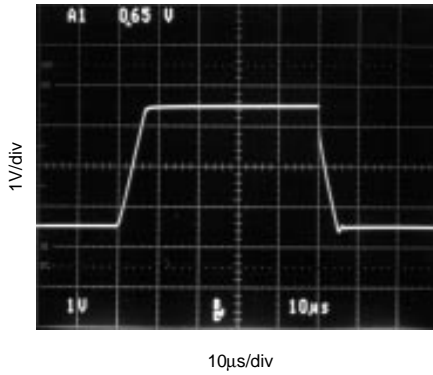

SETTLING TIME vs GAIN

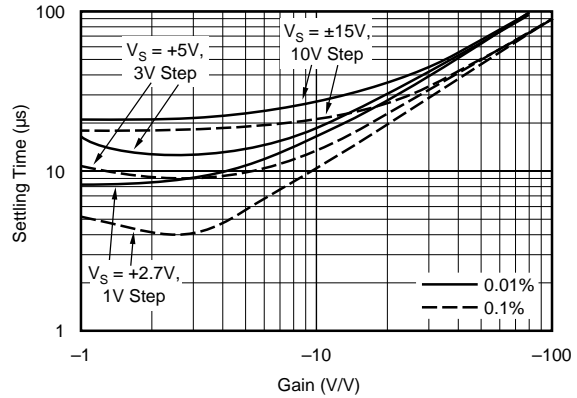

OUTPUT VOLTAGE SWING vs OUTPUT CURRENT

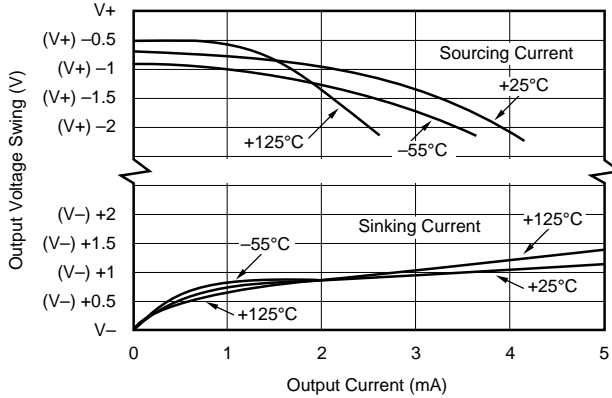

SMALL-SIGNAL OVERSHOOT vs LOAD CAPACITANCE

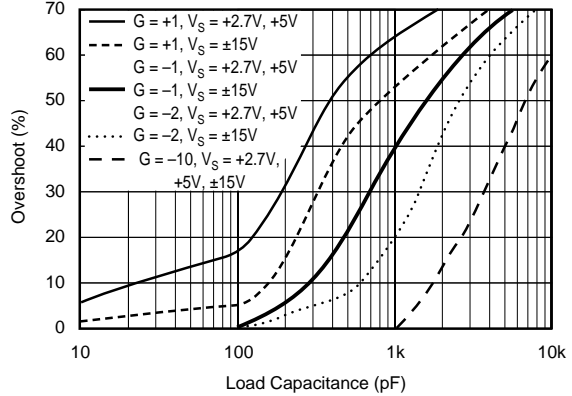



# TYPICAL PERFORMANCE CURVES (CONT)

At  $T_A = +25^\circ\text{C}$  and  $R_L = 10\text{k}\Omega$ , unless otherwise noted.

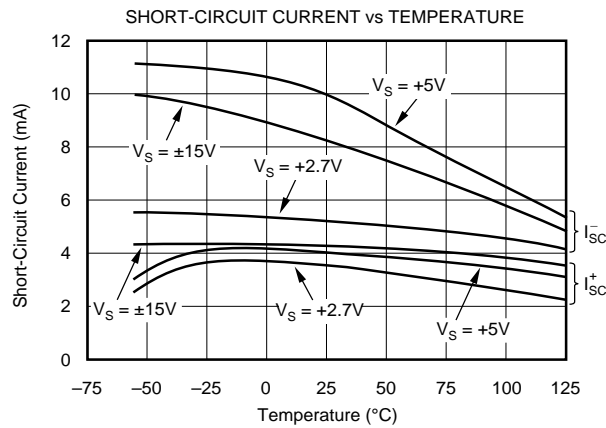
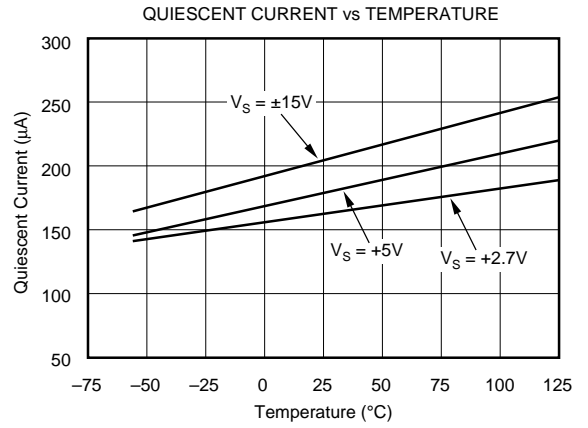
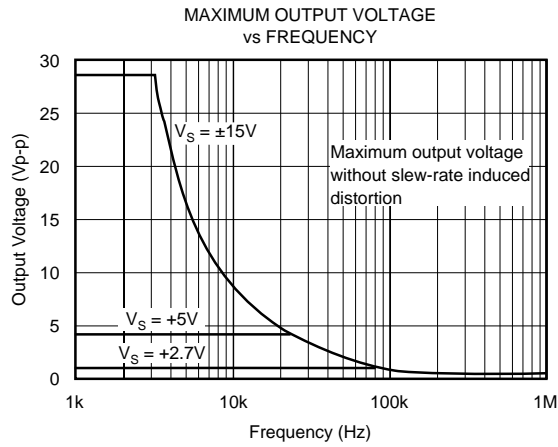

# APPLICATIONS INFORMATION

OPA237 series op amps are unity-gain stable and suitable for a wide range of general-purpose applications. Power supply pins should be bypassed with 10nF ceramic capacitors.

## OPERATING VOLTAGE

OPA237 series op amps operate from single (+2.7V to +36V) or dual ( $\pm 1.35V$  to  $\pm 18V$ ) supplies with excellent performance. Most behavior remains unchanged throughout the full operating voltage range. Parameters which vary significantly with operating voltage are shown in typical performance curves. Specifications are production tested with +2.7V, +5V, and  $\pm 15V$  supplies.

## OUTPUT CURRENT AND STABILITY

OPA237 series op amps can drive large capacitive loads. However, under certain limited output conditions any op amp may become unstable. Figure 1 shows the region where the OPA237 has a potential for instability. These load conditions are rarely encountered, especially for single supply applications. For example, take the case when a

+5V supply with a 10k $\Omega$  load to  $V_S/2$  is used. OPA237 series op amps remain stable with capacitive loads up to 4,000pF, if sinking current and up to 10,000pF, if sourcing current. Furthermore, in single supply applications where the load is connected to ground, the op amp is only sourcing current, and as shown in Figure 1, can drive 10,000pF with output currents up to 1.5mA.

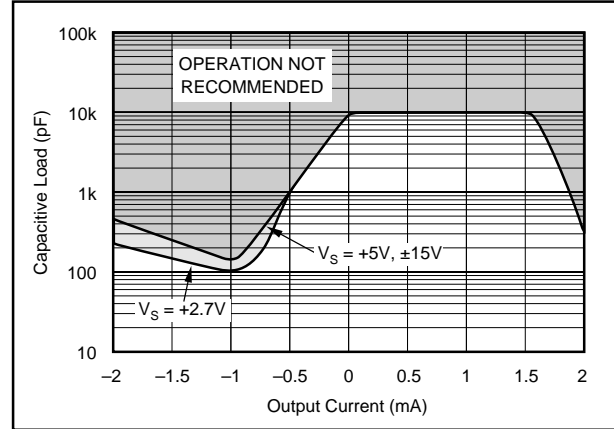

FIGURE 1. Stability-Capacitive Load vs Output Current.

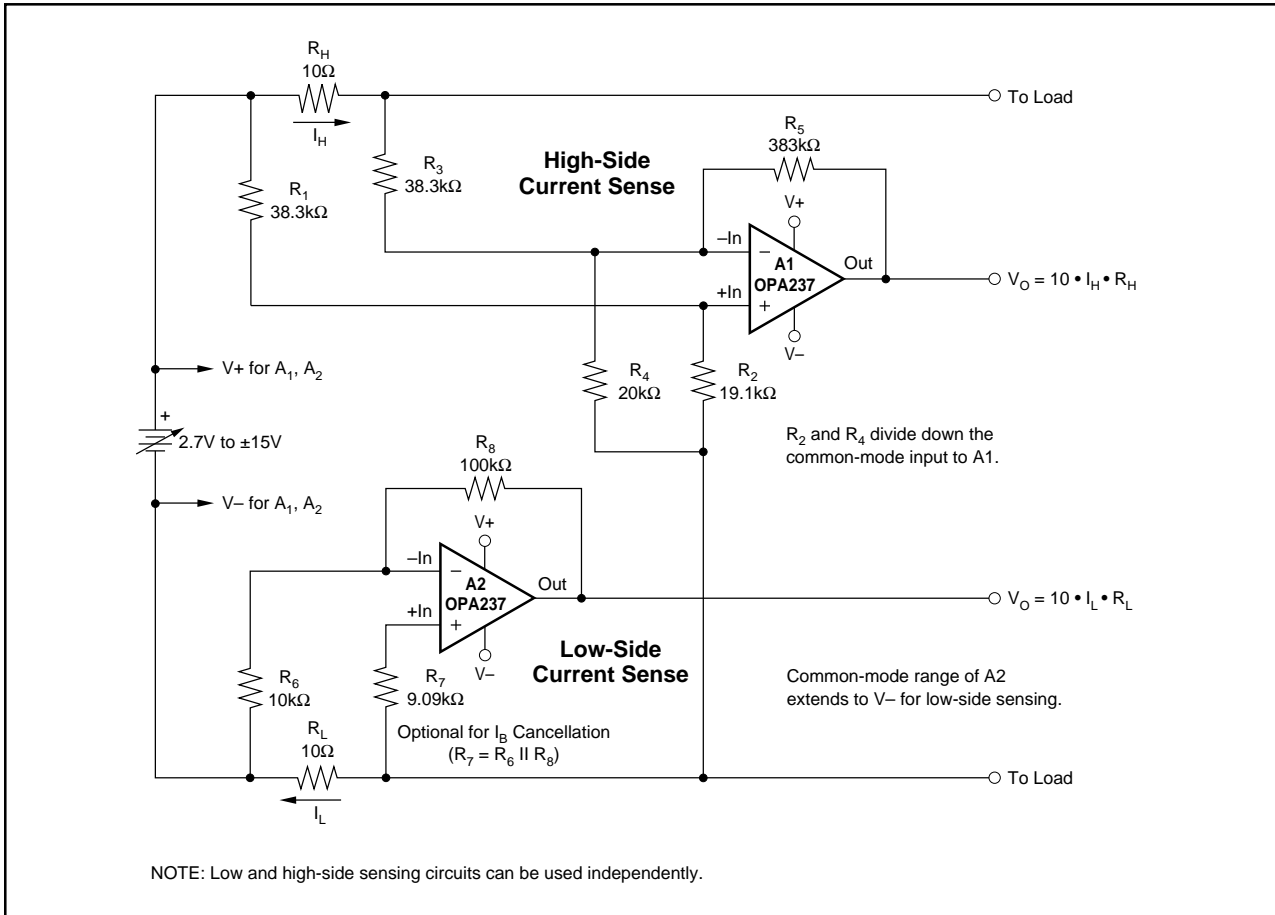

FIGURE 2. Low and High-Side Battery Current Sensing.