

SANYO	No.3191A	LA6358N,6358NS
	High-Performance Dual Operational Amplifiers	

Overview

The LA6358N is an IC integrating two high-performance operational amplifiers in a single package. This operational amplifier contains an internal phase compensator and is designed to operate from a single power supply over a wide range of voltages. As with conventional general-purpose operational amplifiers, operation from dual power supplies is also possible and power dissipation is very low. This IC can be used widely in commercial and industrial applications including various transducer amplifiers and DC amplifiers.

Features

- Eliminates need for phase compensation
- Wide range of operating supply voltage : 3.0 to 30.0V (single power supply)
±1.5 to ±15.0V (dual power supply)
- Input voltage swingable down to nearly ground level and output voltage range V_{OUT} of 0 to $V_{CC} - 1.5V$
- Low current dissipation : $I_{CC} = 0.5mA$ typ/ $V_{CC} = +5V, R_L = \infty$

Maximum Ratings at $T_a = 25^\circ C$

			unit
Maximum Supply Voltage	V_{CC}	32	V
Differential Input Voltage	V_{ID}	32	V
Maximum Input Voltage	$V_{IN\ max}$	-0.3 to +32	V
Allowable Power Dissipation	$P_d\ max$ $T_a \leq 25^\circ C$	570	mW
Operating Temperature	T_{opr}	-30 to +85	$^\circ C$
Storage Temperature	T_{stg}	-55 to +125	$^\circ C$

Operating Characteristics at $T_a = 25^\circ C, V_{CC} = +5V$

			Test Circuit	min	typ	max	unit
Input Offset Voltage	V_{IO}		1		±2	±7	mV
Input Offset Current	I_{IO}	$I_{IN(+)} / I_{IN(-)}$	2		±5	±50	nA
Input Bias Current	I_B	$I_{IN(+)} / I_{IN(-)}$	3		45	250	nA
Common-Mode Input Voltage Range	V_{ICM}		4	0		$V_{CC} - 1.5$	V

Continued on next page.

Package Dimensions 3001B-D8IC
(unit : mm)

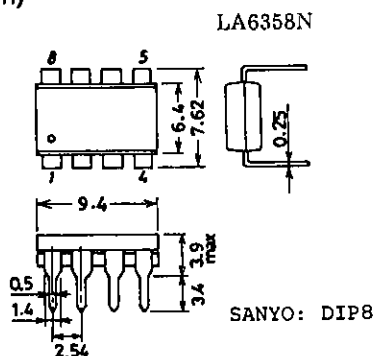

Package Dimensions 3017B-S9IC
(unit : mm)

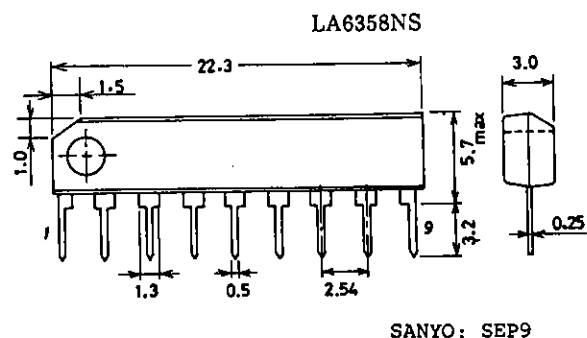

Continued from preceding page.

			Test Circuit	min	typ	max	unit
Common-Mode Rejection Ratio	CMR		4	65	80		dB
Large Signal Voltage Gain	VG	$V_{CC} = 15V, R_L \geq 2k\Omega$	5	25	100		V/mV
Output Voltage Range	V_{OUT}			0	$V_{CC} - 1.5$		V
Power Supply Rejection Ratio	SVR		6	65	100		dB
Channel Separation		$f = 1k \text{ to } 20kHz$	7		120		dB
Current Dissipation	I_{CC}		8		0.5	1.2	mA
Output Current (Source)	$I_{O \text{ source}}$	$V_{IN+} = 1V, V_{IN-} = 0V$	9	20	40		mA
Output Current (Sink)	$I_{O \text{ sink}}$	$V_{IN+} = 0V, V_{IN-} = 1V$	10	10	20		mA

Equivalent Circuit

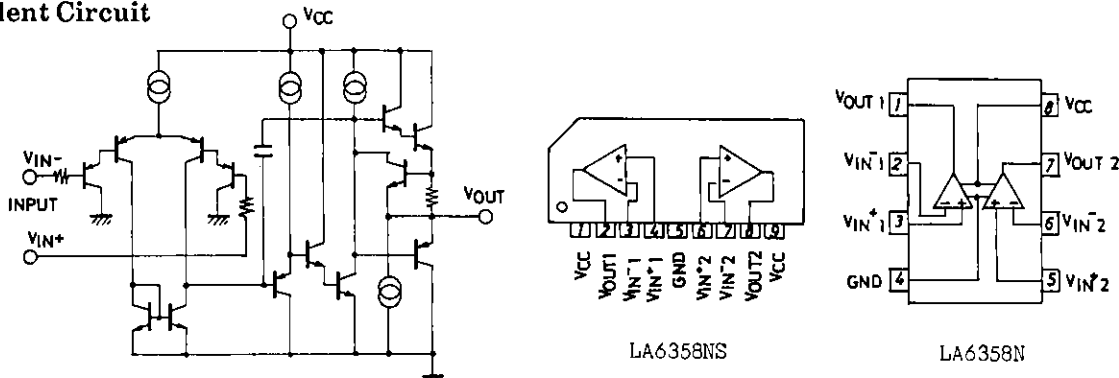

Test Circuits

1. Input Offset Voltage V_{IO}

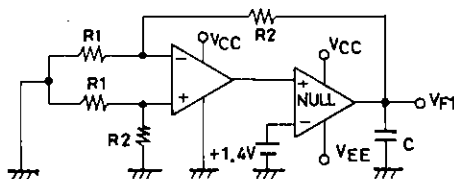

$$V_{IO} = \frac{VF1}{1 + R2/R1}$$

2. Input Offset Current I_{IO}

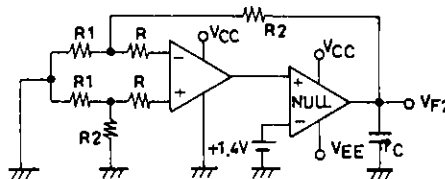

$$I_{IO} = \frac{VF2 - VF1}{R(1 + R2/R1)}$$

3. Input Bias Current I_B

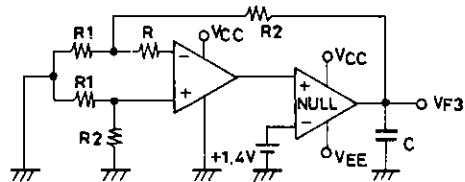

$$I_B = \frac{VF4 - VF3}{2R(1 + R2/R1)}$$

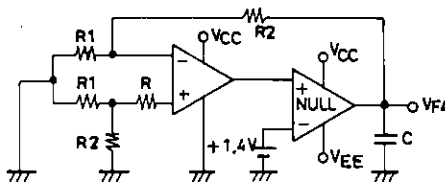

4. Common-mode Rejection Ratio CMR
Common-mode Input Voltage Range V_{ICM}

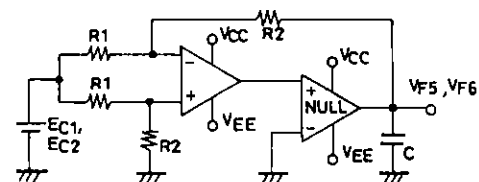

$$CMR = 20 \log \left| \frac{(EC1 - EC2)(1 + R2/R1)}{VF5 - VF6} \right|$$

5. Voltage Gain VG

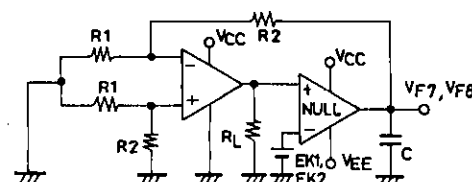

$$VG = \frac{(EK1 - EK2)(1 + R2/R1)}{VF8 - VF7}$$

6. Supply Voltage Rejection SVR

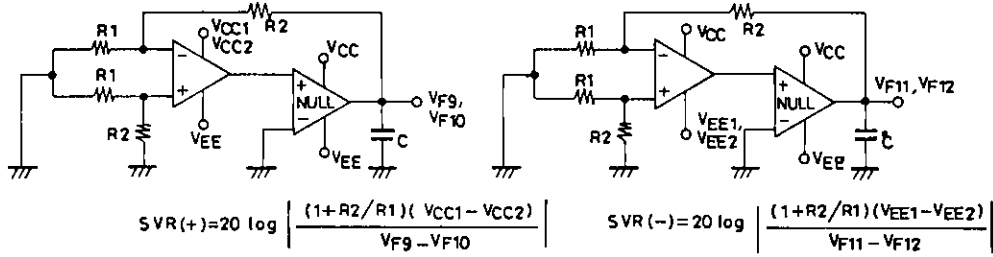

7. Channel Separation CS

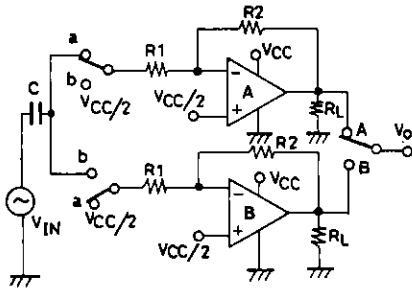

SW : a

$$CS(A \rightarrow B) + 20 \log \frac{R_2 V_{OA}}{R_1 V_{OB}}$$

SW : b

$$CS(B \rightarrow A) + 20 \log \frac{R_2 V_{OB}}{R_1 V_{OA}}$$

8. Current Dissipation ICC

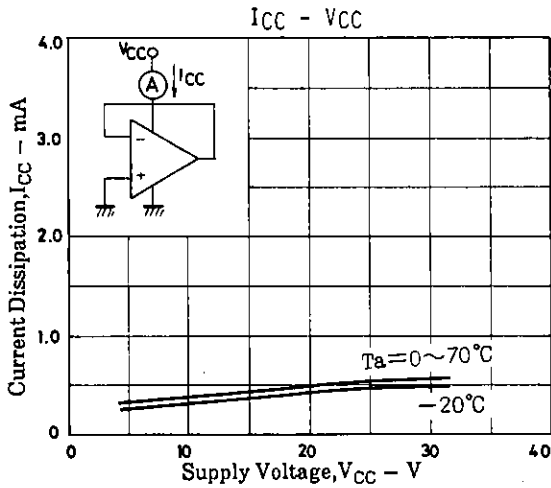
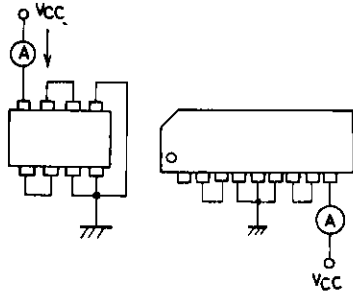

9. Output Current IO source

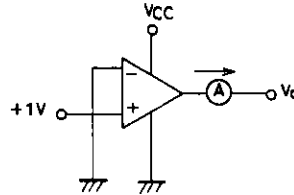

10. Output Current IO sink

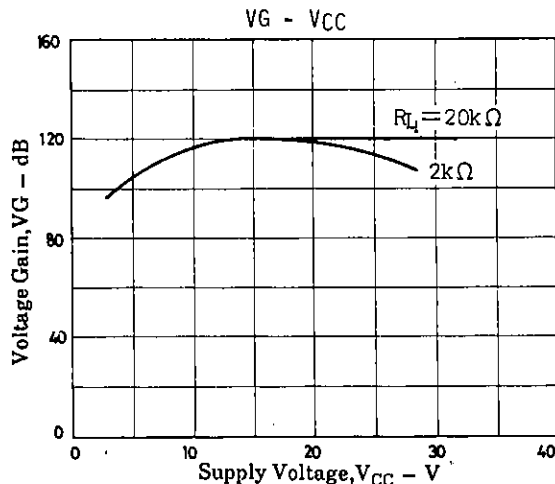
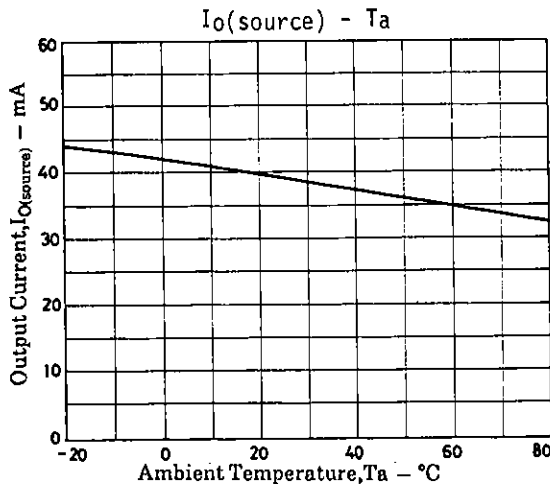
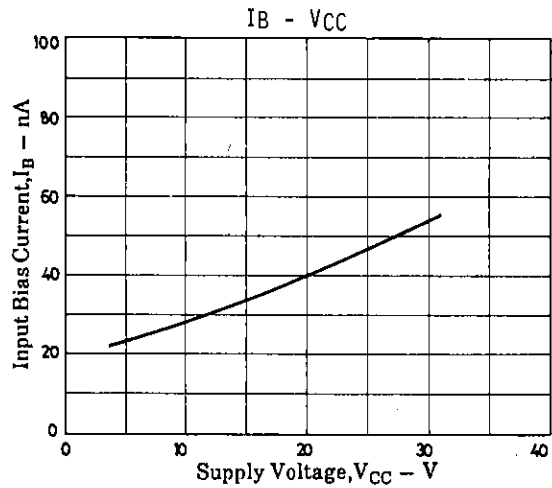
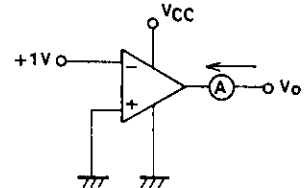

LA6358N, 6358NS

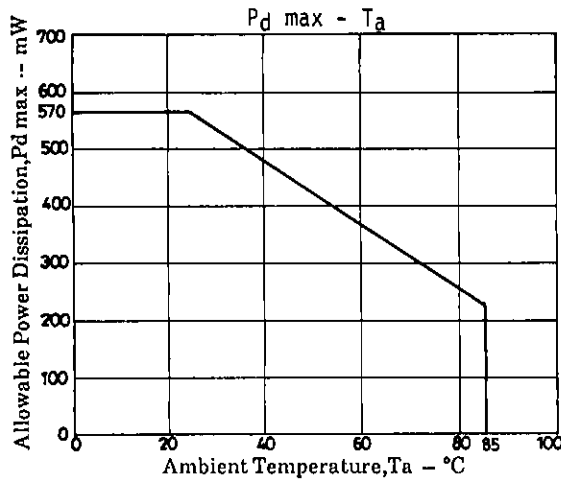
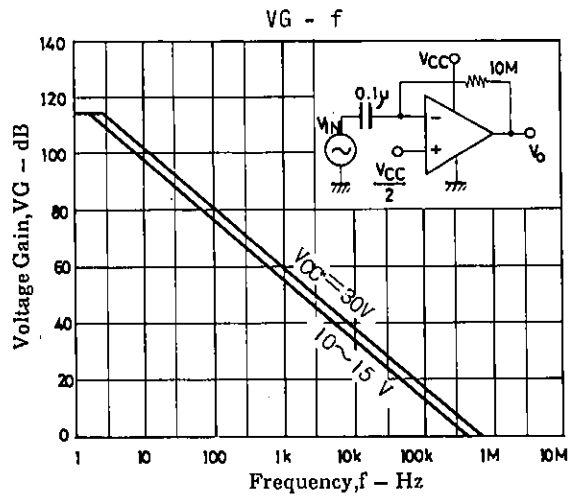
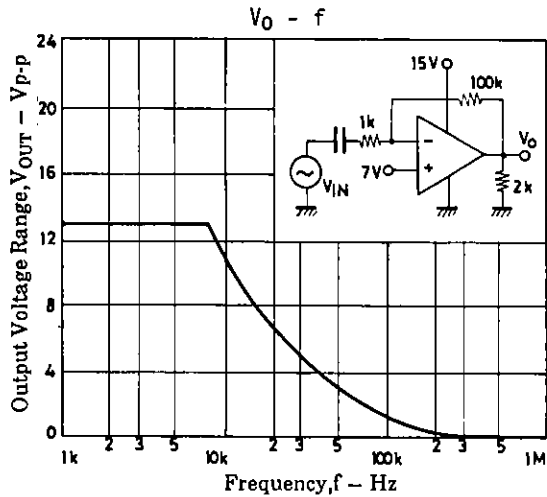

Sample Application Circuits

Noninverting DC amplifier

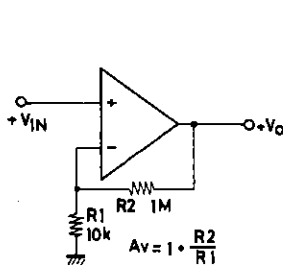

Inverting AC amplifier

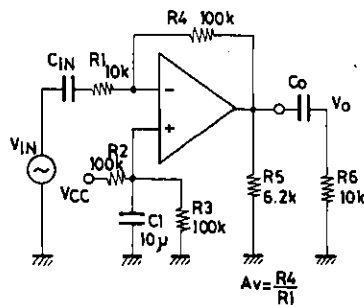

Rectangular wave oscillator

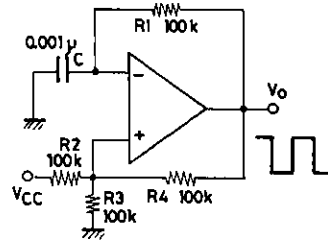

Unit (resistance: Ω capacitance: F)

- No products described or contained herein are intended for use in surgical implants, life-support systems, aerospace equipment, nuclear power control systems, vehicles, disaster/crime-prevention equipment and the like, the failure of which may directly or indirectly cause injury, death or property loss.
- Anyone purchasing any products described or contained herein for an above-mentioned use shall:
 - ① Accept full responsibility and indemnify and defend SANYO ELECTRIC CO., LTD., its affiliates, subsidiaries and distributors and all their officers and employees, jointly and severally, against any and all claims and litigation and all damages, cost and expenses associated with such use;
 - ② Not impose any responsibility for any fault or negligence which may be cited in any such claim or litigation on SANYO ELECTRIC CO., LTD., its affiliates, subsidiaries and distributors or any of their officers and employees jointly or severally.
- Information (including circuit diagrams and circuit parameters) herein is for example only; it is not guaranteed for volume production. SANYO believes information herein is accurate and reliable, but no guarantees are made or implied regarding its use or any infringements of intellectual property rights or other rights of third parties.