

1 - Cathode
2 - Anode
Back of Case - Cathode

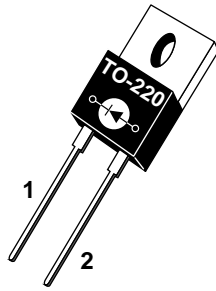

**ADVANCED
POWER
TECHNOLOGY®**
APT15D100K 1000V 15A

ULTRAFAST SOFT RECOVERY RECTIFIER DIODE

PRODUCT APPLICATIONS	PRODUCT FEATURES	PRODUCT BENEFITS
<ul style="list-style-type: none"> • Anti-Parallel Diode <ul style="list-style-type: none"> -Switchmode Power Supply -Inverters • Free Wheeling Diode <ul style="list-style-type: none"> -Motor Controllers -Converters • Snubber Diode • Uninterruptible Power Supply (UPS) • Induction Heating • High Speed Rectifiers 	<ul style="list-style-type: none"> • Ultrafast Recovery Times • Soft Recovery Characteristics • Popular TO-220 Package • Low Forward Voltage • High Blocking Voltage • Low Leakage Current 	<ul style="list-style-type: none"> • Low Losses • Low Noise Switching • Cooler Operation • Higher Reliability Systems • Increased System Power Density

MAXIMUM RATINGS

All Ratings: $T_C = 25^\circ\text{C}$ unless otherwise specified.

Symbol	Characteristic / Test Conditions	APT15D100K	UNIT
V_R	Maximum D.C. Reverse Voltage	1000	Volts
V_{RRM}	Maximum Peak Repetitive Reverse Voltage		
V_{RWM}	Maximum Working Peak Reverse Voltage		
$I_F(AV)$	Maximum Average Forward Current ($T_C = 90^\circ\text{C}$, Duty Cycle = 0.5)	15	Amps
$I_F(RMS)$	RMS Forward Current	25	
I_{FSM}	Non-Repetitive Forward Surge Current ($T_J = 45^\circ\text{C}$, 8.3ms)	80	
T_J, T_{STG}	Operating and Storage Temperature Range	-55 to 150	$^\circ\text{C}$
T_L	Lead Temperature: 0.063" from Case for 10 Sec.	300	

STATIC ELECTRICAL CHARACTERISTICS

Symbol	Characteristic / Test Conditions	MIN	TYP	MAX	UNIT
V_F	Maximum Forward Voltage			2.3	Volts
				$I_F = 15\text{A}$	
				$I_F = 30\text{A}$	
I_{RM}	Maximum Reverse Leakage Current			1.9	μA
				$I_F = 15\text{A}, T_J = 150^\circ\text{C}$	
				$V_R = V_R \text{ Rated}$	
				500	
C_T	Junction Capacitance, $V_R = 200\text{V}$		12		pF
L_S	Series Inductance (Lead to Lead 5mm from Base)		10		nH

USA
405 S.W. Columbia Street
EUROPE
Avenue J.F. Kennedy Bât B4 Parc Cadéra Nord

APT Website - <http://www.advancedpower.com>

Bend, Oregon 97702-1035 Phone: (541) 382-8028 FAX: (541) 388-0364
F-33700 Merignac - France Phone: (33) 557 92 15 15 FAX: (33) 556 47 97 61

DYNAMIC CHARACTERISTICS

APT15D100K

Symbol	Characteristic	MIN	TYP	MAX	UNIT
t_{rr1}	Reverse Recovery Time, $I_F = 1.0A$, $di_F/dt = -15A/\mu s$, $V_R = 30V$, $T_J = 25^\circ C$		60	75	ns
t_{rr2}	Reverse Recovery Time		60		
t_{rr3}	$I_F = 15A$, $di_F/dt = -100A/\mu s$, $V_R = 540V$		120		
t_{fr1}	Forward Recovery Time		180		
t_{fr2}	$I_F = 15A$, $di_F/dt = 100A/\mu s$, $V_R = 540V$		180		
I_{RRM1}	Reverse Recovery Current		3.8	7	Amps
I_{RRM2}	$I_F = 15A$, $di_F/dt = -100A/\mu s$, $V_R = 540V$		4.5	9	
Q_{rr1}	Recovery Charge		114		nC
Q_{rr2}	$I_F = 15A$, $di_F/dt = -100A/\mu s$, $V_R = 540V$		270		
V_{fr1}	Forward Recovery Voltage		5.8		Volts
V_{fr2}	$I_F = 15A$, $di_F/dt = 100A/\mu s$, $V_R = 540V$		5.8		
diM/dt	Rate of Fall of Recovery Current		100		A/ μs
	$I_F = 15A$, $di_F/dt = -100A/\mu s$, $V_R = 540V$ (See Figure 10)		50		

THERMAL AND MECHANICAL CHARACTERISTICS

Symbol	Characteristic / Test Conditions	MIN	TYP	MAX	UNIT
$R_{\theta JC}$	Junction-to-Case Thermal Resistance			1.7	$^\circ C/W$
$R_{\theta JA}$	Junction-to-Ambient Thermal Resistance			80	
W_T	Package Weight		0.07		oz
			1.9		gm
Torque	Maximum Mounting Torque (Screw Type = 6-32 or 3.5mm Machine)			6.4	lb•in
				0.7	N•m

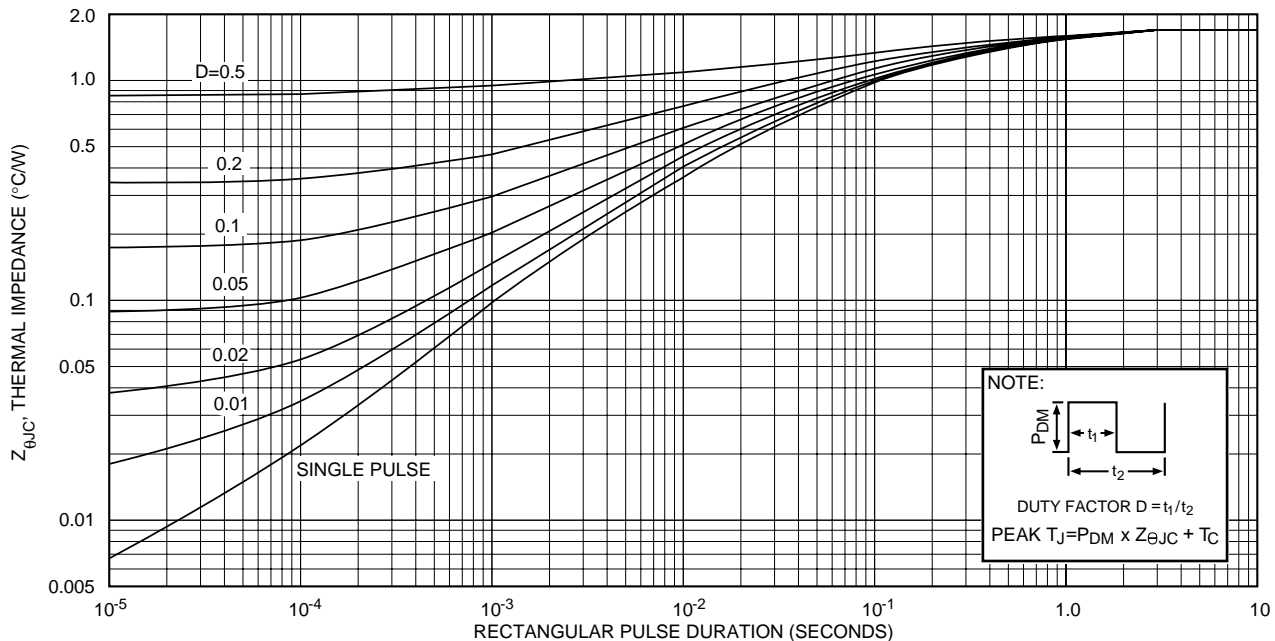

Figure 1, Maximum Effective Transient Thermal Impedance, Junction-To-Case vs Pulse Duration

APT15D100K

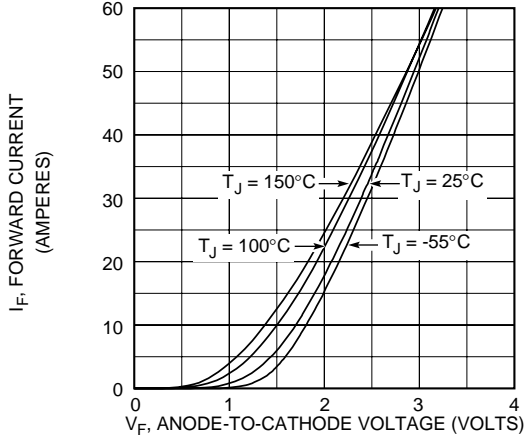

Figure 2, Forward Voltage Drop vs Forward Current

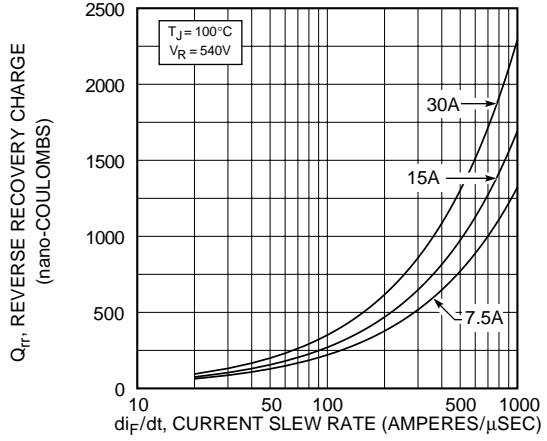

Figure 3, Reverse Recovery Charge vs Current Slew Rate

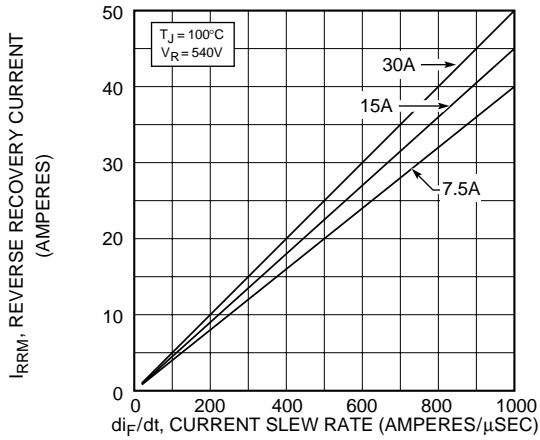

Figure 4, Reverse Recovery Current vs Current Slew Rate

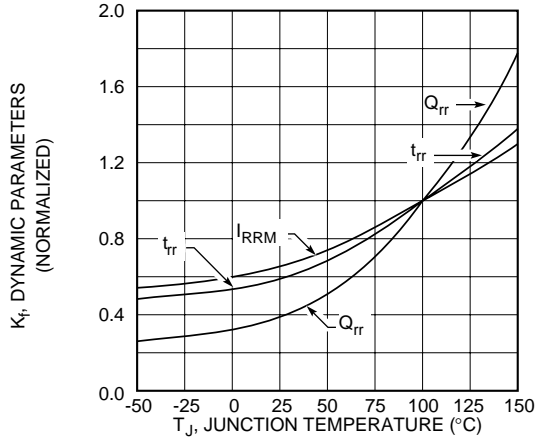

Figure 5, Dynamic Parameters vs Junction Temperature

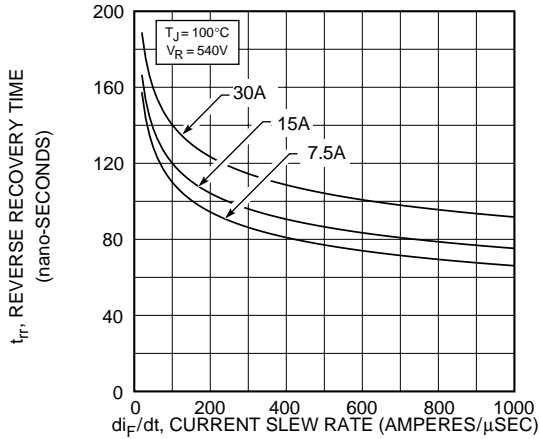

Figure 6, Reverse Recovery Time vs Current Slew Rate

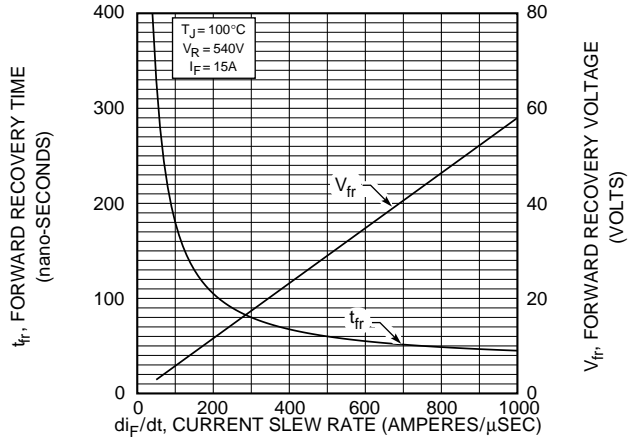

Figure 7, Forward Recovery Voltage/Time vs Current Slew Rate

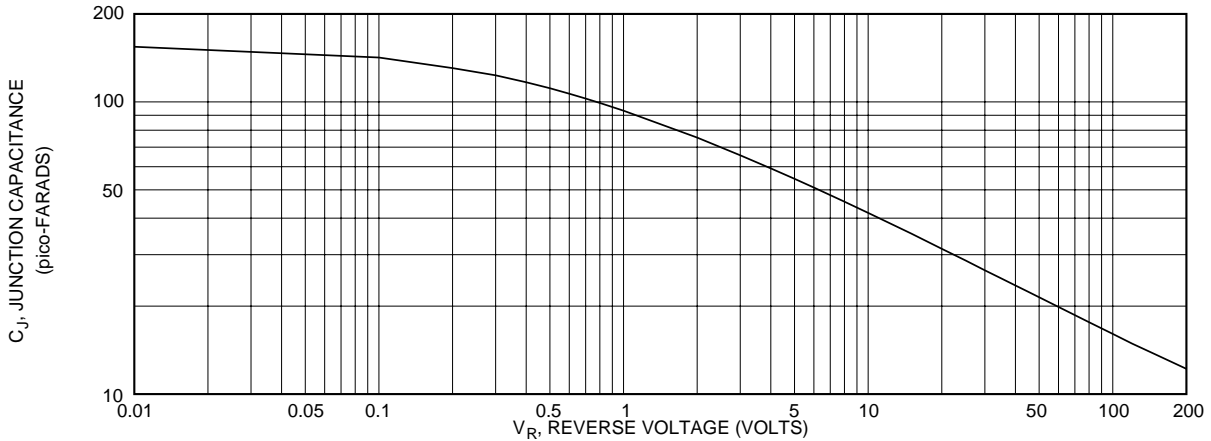

Figure 8, Junction Capacitance vs Reverse Voltage

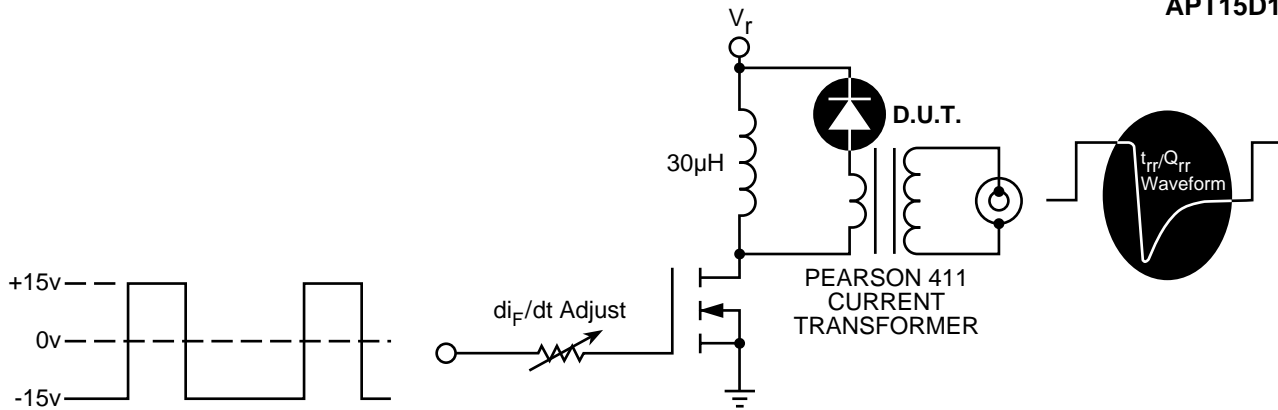

Figure 9, Diode Reverse Recovery Test Circuit and Waveforms

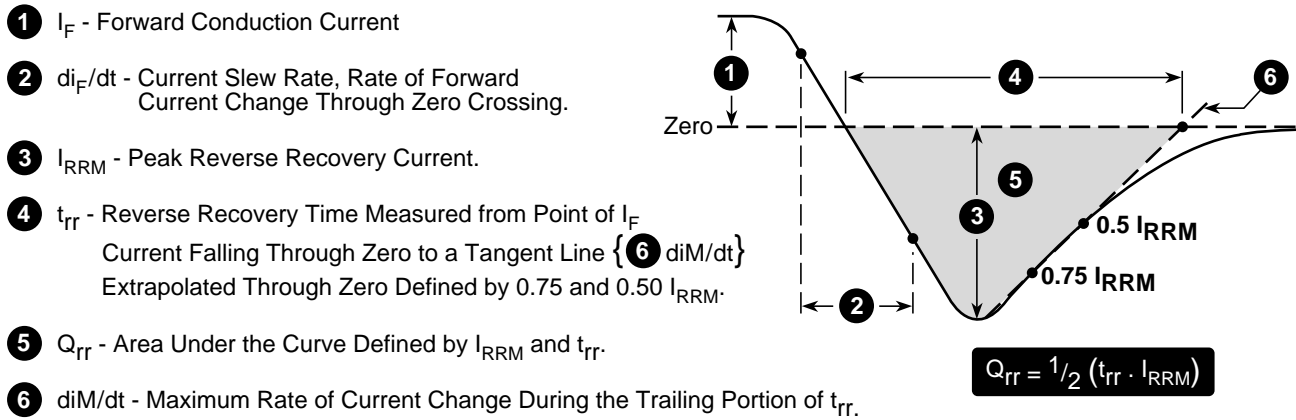

Figure 10, Diode Reverse Recovery Waveform and Definitions

APT Reserves the right to change, without notice, the specifications and information contained herein.

TO-220AB Package Outline

