

---

# 2SC1775, 2SC1775A

Silicon NPN Epitaxial

# HITACHI

ADE-208-1056 (Z)  
1st. Edition  
Mar. 2001

---

## Application

- Low frequency low noise amplifier
- Complementary pair with 2SA872/A

## Outline

TO-92 (1)

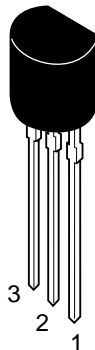

1. Emitter
2. Collector
3. Base

# 2SC1775, 2SC1775A

## Absolute Maximum Ratings (Ta = 25°C)

Item	Symbol	2SC1775	2SC1775A	Unit
Collector to base voltage	$V_{CBO}$	90	120	V
Collector to emitter voltage	$V_{CEO}$	90	120	V
Emitter to base voltage	$V_{EBO}$	5	5	V
Collector current	$I_C$	50	50	mA
Collector power dissipation	$P_C$	300	300	mW
Junction temperature	$T_j$	150	150	°C
Storage temperature	$T_{stg}$	-55 to +150	-50 to +150	°C

## Electrical Characteristics (Ta = 25°C)

Item	Symbol	2SC1775			2SC1775A			Unit	Test conditions	
		Min	Typ	Max	Min	Typ	Max			
Collector to emitter breakdown voltage	$V_{(BR)CEO}$	90	—	—	120	—	—	V	$I_C = 1 \text{ mA}$ , $R_{BE} = \infty$	
Collector cutoff current	$I_{CBO}$	—	—	0.5	—	—	—	$\mu\text{A}$	$V_{CB} = 75 \text{ V}$ , $I_E = 0$	
		—	—	—	—	—	0.5	$\mu\text{A}$	$V_{CB} = 100 \text{ V}$ , $I_E = 0$	
DC current transfer ratio	$h_{FE1}^{*1}$	400	—	1200	400	—	1200		$V_{CE} = 12 \text{ V}$ , $I_C = 2 \text{ mA}$	
	$h_{FE2}$	160	—	—	160	—	—		$V_{CE} = 12 \text{ V}$ , $I_C = 0.1 \text{ mA}$	
Base to emitter voltage	$V_{BE}$	—	—	0.75	—	—	0.75	V	$V_{CE} = 12 \text{ V}$ , $I_C = 2 \text{ mA}$	
Collector to emitter saturation voltage	$V_{CE(sat)}$	—	—	0.5	—	—	0.5	V	$I_C = 10 \text{ mA}$ , $I_B = 1 \text{ mA}$	
Gain bandwidth product	$f_T$	—	200	—	—	200	—	MHz	$V_{CE} = 12 \text{ V}$ , $I_C = 2 \text{ mA}$	
Collector output capacitance	$C_{ob}$	—	1.6	—	—	1.6	—	pF	$V_{CB} = 25 \text{ V}$ , $I_E = 0$ , $f = 1 \text{ MHz}$	
Noise figure	NF	—	—	5.0	—	—	5.0	dB	$V_{CE} = 6 \text{ V}$ , $I_C = 50 \mu\text{A}$ , $R_g = 50 \text{ k}\Omega$	$f = 10 \text{ Hz}$
		—	—	1.5	—	—	1.5	dB		$f = 1 \text{ kHz}$

Note: 1. The 2SC1775/A is grouped by  $h_{FE1}$  as follows.

E	F
400 to 800	600 to 1200

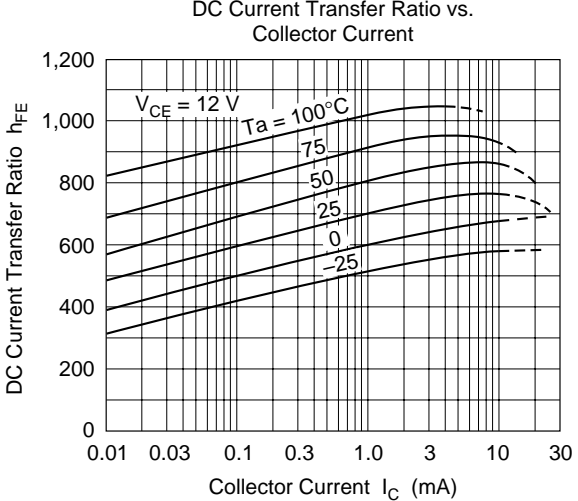
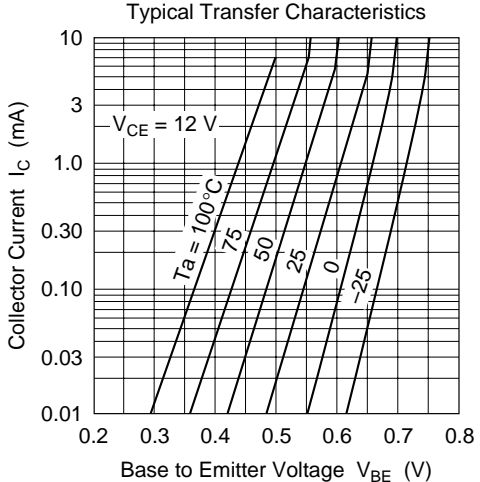
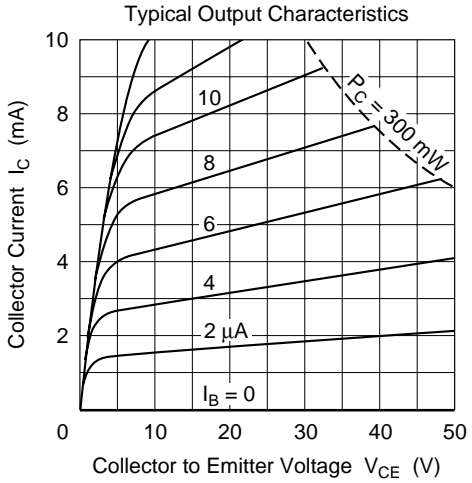
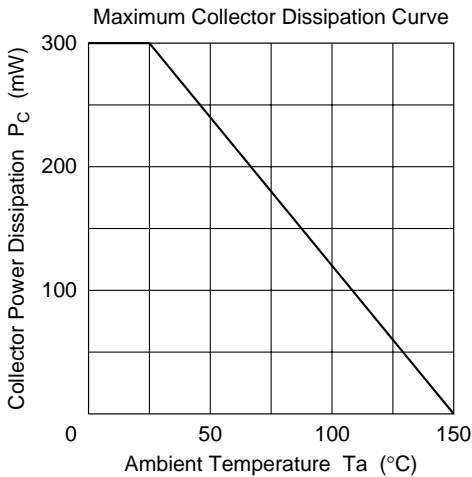

Gain Bandwidth Product vs. Collector Current

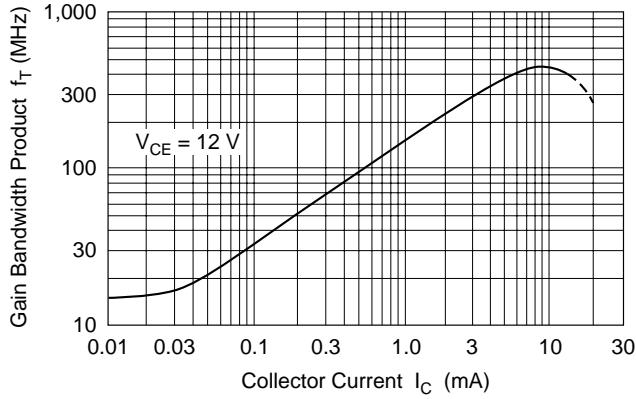

Collector Output Capacitance vs. Collector to Base Voltage

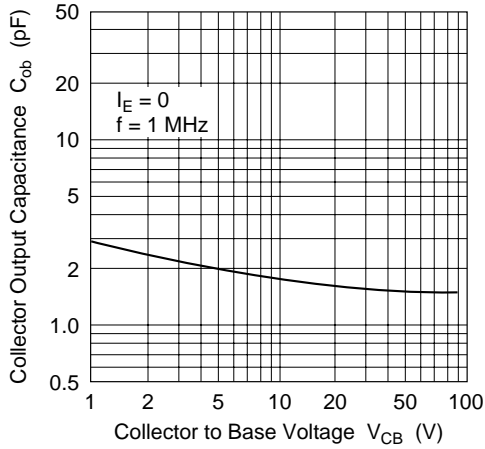

Contours of Constant Noise Figure

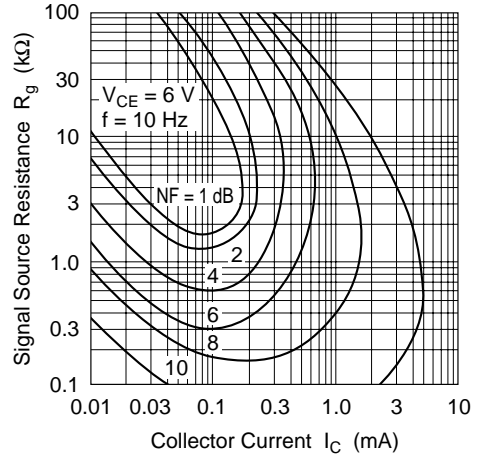

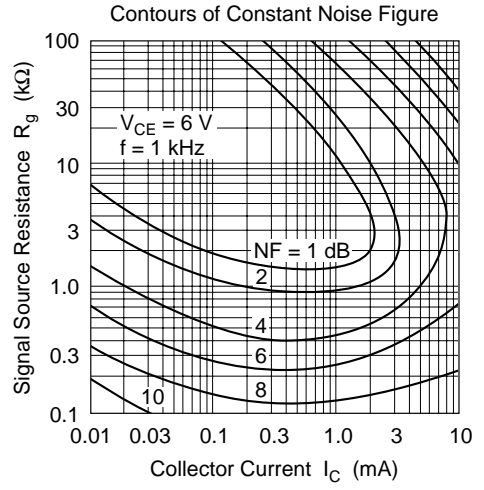
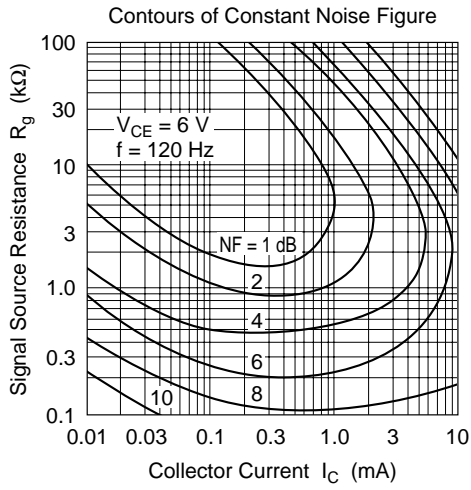

## Package Dimensions

As of January, 2001  
Unit: mm

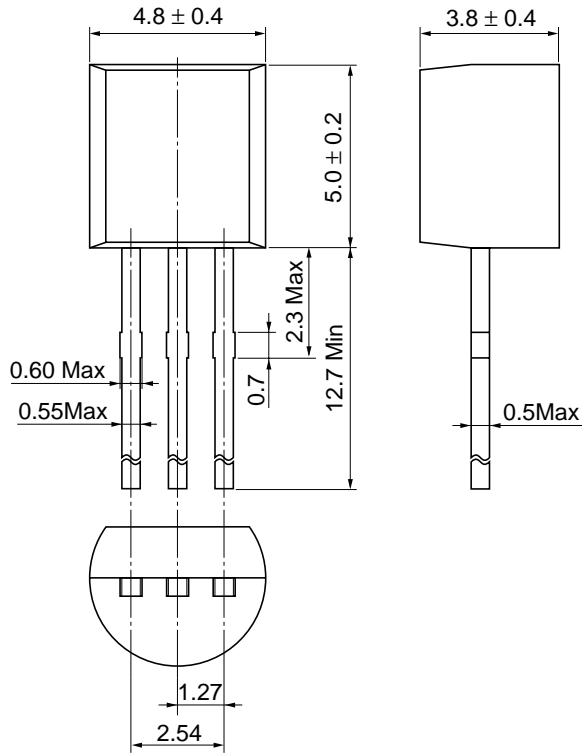

Hitachi Code	TO-92 (1)
JEDEC	Conforms
EIAJ	Conforms
Mass (reference value)	0.25 g

## Cautions

1. Hitachi neither warrants nor grants licenses of any rights of Hitachi's or any third party's patent, copyright, trademark, or other intellectual property rights for information contained in this document. Hitachi bears no responsibility for problems that may arise with third party's rights, including intellectual property rights, in connection with use of the information contained in this document.
2. Products and product specifications may be subject to change without notice. Confirm that you have received the latest product standards or specifications before final design, purchase or use.
3. Hitachi makes every attempt to ensure that its products are of high quality and reliability. However, contact Hitachi's sales office before using the product in an application that demands especially high quality and reliability or where its failure or malfunction may directly threaten human life or cause risk of bodily injury, such as aerospace, aeronautics, nuclear power, combustion control, transportation, traffic, safety equipment or medical equipment for life support.
4. Design your application so that the product is used within the ranges guaranteed by Hitachi particularly for maximum rating, operating supply voltage range, heat radiation characteristics, installation conditions and other characteristics. Hitachi bears no responsibility for failure or damage when used beyond the guaranteed ranges. Even within the guaranteed ranges, consider normally foreseeable failure rates or failure modes in semiconductor devices and employ systemic measures such as fail-safes, so that the equipment incorporating Hitachi product does not cause bodily injury, fire or other consequential damage due to operation of the Hitachi product.
5. This product is not designed to be radiation resistant.
6. No one is permitted to reproduce or duplicate, in any form, the whole or part of this document without written approval from Hitachi.
7. Contact Hitachi's sales office for any questions regarding this document or Hitachi semiconductor products.

# HITACHI

## Hitachi, Ltd.

Semiconductor & Integrated Circuits.  
Nippon Bldg., 2-6-2, Ohte-machi, Chiyoda-ku, Tokyo 100-0004, Japan  
Tel: Tokyo (03) 3270-2111 Fax: (03) 3270-5109

URL	NorthAmerica	: <a href="http://semiconductor.hitachi.com/">http://semiconductor.hitachi.com/</a>
	Europe	: <a href="http://www.hitachi-eu.com/hel/ecg">http://www.hitachi-eu.com/hel/ecg</a>
	Asia	: <a href="http://sicapac.hitachi-asia.com">http://sicapac.hitachi-asia.com</a>
	Japan	: <a href="http://www.hitachi.co.jp/Sicd/indx.htm">http://www.hitachi.co.jp/Sicd/indx.htm</a>

### For further information write to:

Hitachi Semiconductor  
(America) Inc.  
179 East Tasman Drive,  
San Jose, CA 95134  
Tel: <1> (408) 433-1990  
Fax: <1> (408) 433-0223

Hitachi Europe GmbH  
Electronic Components Group  
Dornacher Straße 3  
D-85622 Feldkirchen, Munich  
Germany  
Tel: <49> (89) 9 9180-0  
Fax: <49> (89) 9 29 30 00

Hitachi Europe Ltd.  
Electronic Components Group.  
Whitebrook Park  
Lower Cookham Road  
Maidenhead  
Berkshire SL6 8YA, United Kingdom  
Tel: <44> (1628) 585000  
Fax: <44> (1628) 585160

Hitachi Asia Ltd.  
Hitachi Tower  
16 Collyer Quay #20-00,  
Singapore 049318  
Tel: <65>-538-6533/538-8577  
Fax: <65>-538-6933/538-3877  
URL: <http://www.hitachi.com.sg>

Hitachi Asia Ltd.  
(Taipei Branch Office)  
4/F, No. 167, Tun Hwa North Road,  
Hung-Kuo Building,  
Taipei (105), Taiwan  
Tel: <886>-(2)-2718-3666  
Fax: <886>-(2)-2718-8180  
Telex: 23222 HAS-TP  
URL: <http://www.hitachi.com.tw>

Hitachi Asia (Hong Kong) Ltd.  
Group III (Electronic Components)  
7/F., North Tower,  
World Finance Centre,  
Harbour City, Canton Road  
Tsim Sha Tsui, Kowloon,  
Hong Kong  
Tel: <852>-(2)-735-9218  
Fax: <852>-(2)-730-0281  
URL: <http://www.hitachi.com.hk>

Copyright © Hitachi, Ltd., 2000. All rights reserved. Printed in Japan.  
Colophon 2.0