2SC458(K)

Silicon NPN Epitaxial

HITACHI

ADE-208-1045 (Z)

1st. Edition

Mar. 2001

Application

- Low frequency amplifier
- Medium speed switching

Outline

TO-92 (1)

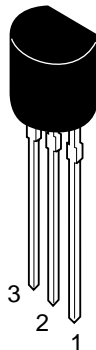

1. Emitter
2. Collector
3. Base

2SC458 (K)

Absolute Maximum Ratings (Ta = 25°C)

Item	Symbol	Ratings	Unit
Collector to base voltage	V_{CBO}	30	V
Collector to emitter voltage	V_{CEO}	30	V
Emitter to base voltage	V_{EBO}	5	V
Collector current	I_C	100	mA
Emitter current	I_E	-100	mA
Collector power dissipation	P_C	200	mW
Junction temperature	T_j	150	°C
Storage temperature	T_{stg}	-55 to +150	°C

Electrical Characteristics (Ta = 25°C)

Item	Symbol	Min	Typ	Max	Unit	Test conditions
Collector to base breakdown voltage	$V_{(BR)CBO}$	30	—	—	V	$I_C = 10 \mu A, I_E = 0$
Collector to emitter breakdown voltage	$V_{(BR)CEO}$	30	—	—	V	$I_C = 1 \text{ mA}, R_{BE} = \infty$
Emitter to base breakdown voltage	$V_{(BR)EBO}$	5	—	—	V	$I_E = 10 \mu A, I_C = 0$
Collector cutoff current	I_{CBO}	—	—	0.5	μA	$V_{CB} = 18 \text{ V}, I_E = 0$
Emitter cutoff current	I_{EBO}	—	—	1.0	μA	$V_{EB} = 4 \text{ V}, I_C = 0$
DC current transfer ratio	h_{FE}^{*1}	100	—	500		$V_{CE} = 1 \text{ V}, I_C = 10 \text{ mA}$
Collector to emitter saturation voltage	$V_{CE(sat)}$	—	—	0.4	V	$I_C = 10 \text{ mA}, I_B = 1 \text{ mA}$
Base to emitter voltage	$V_{BE(sat)}$	—	—	1.0	V	$I_C = 10 \text{ mA}, I_B = 1 \text{ mA}$
Gain bandwidth product	f_T	100	—	—	MHz	$V_{CE} = 10 \text{ V}, I_C = 10 \text{ mA}$
Collector output capacitance	C_{ob}	—	—	4	pF	$V_{CB} = 10 \text{ V}, I_E = 0, f = 1 \text{ MHz}$
Turn on time	t_{on}	—	80	—	ns	$I_C = 10 \text{ mA}, I_{B1} = -10 \text{ mA}, I_{B2} = 10 \text{ mA}, V_{CC} = 10 \text{ V}$
Turn off time	t_{off}	—	300	—	ns	
Storage time	t_{stg}	—	260	—	ns	$I_C = I_{B1} = -I_{B2} = 20 \text{ mA}, V_{CC} = 5 \text{ V}$

Note: 1. The 2SC458 (K) is grouped by h_{FE} as follows.

B	C	D
100 to 200	160 to 320	250 to 500

Small Signal h Parameters

Item	Symbol	Typ	Unit	Test conditions
Input impedance	h_{ie}	16.5	$k\Omega$	$V_{CE} = 5\text{ V}$, $I_C = 0.1\text{ mA}$, $f = 270\text{ Hz}$
Voltage feedback ratio	h_{re}	70	$\times 10^{-6}$	
Current transfer ratio	h_{fe}	130		
Output admittance	h_{oe}	11	μS	

Switching Time Test Circuit
 t_{on} , t_{off} Test Circuit

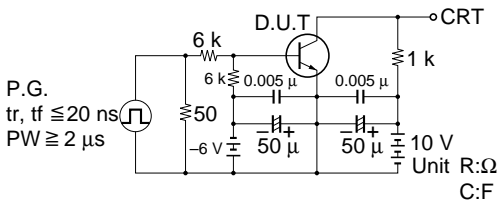

Switching Time Test Circuit
 t_{stg} Test Circuit

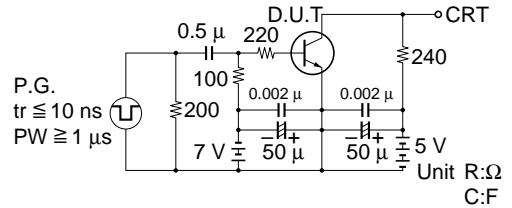

Response Waveform

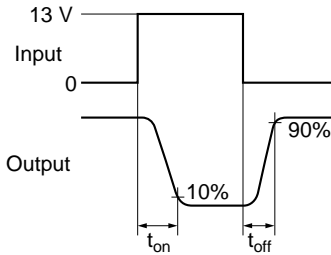

I_C	I_{B1}	I_{B2}	V_{CC}	V_{BB}	V_{in}
10 mA	1 mA	-1 mA	10 V	-6 V	13 V

Response Waveform

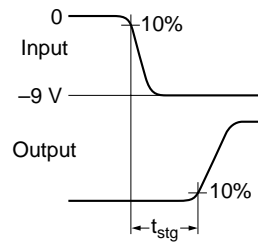

I_C	I_{B1}	I_{B2}	V_{CC}	V_{BB}	V_{in}
20 mA	20 mA	-20 mA	5 V	7 V	-9 V

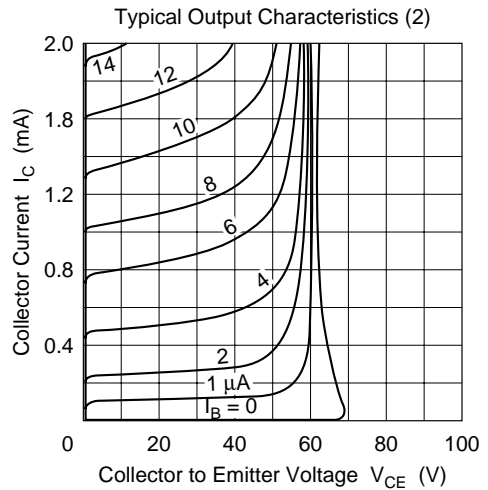
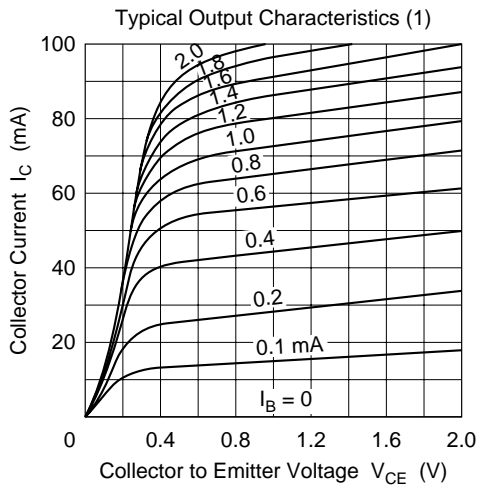
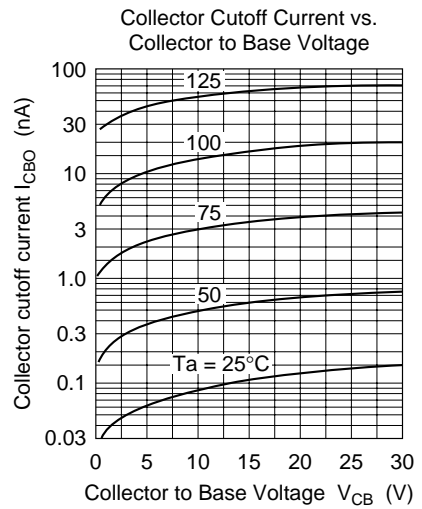
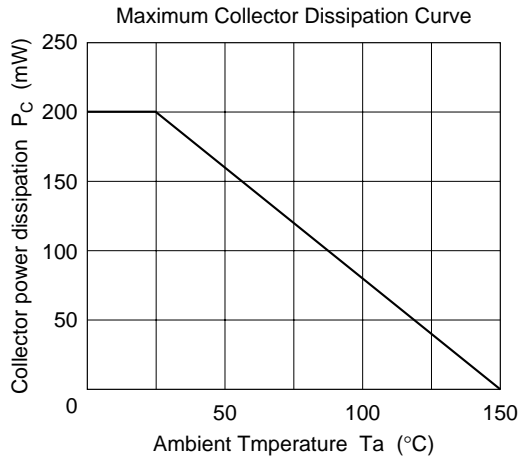

Collector to Emitter Saturation Voltage vs. Base Current

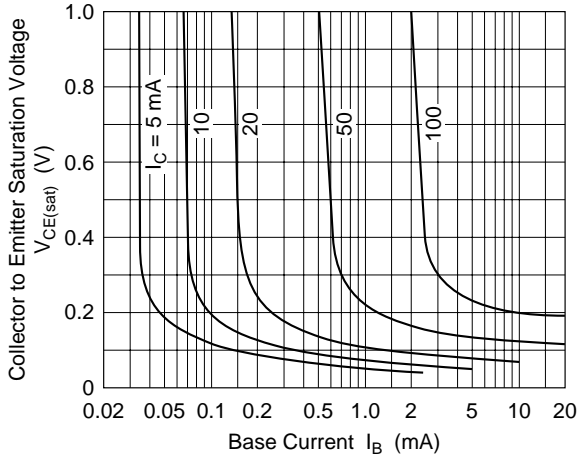

DC Current Transfer Ratio vs. Collector Current

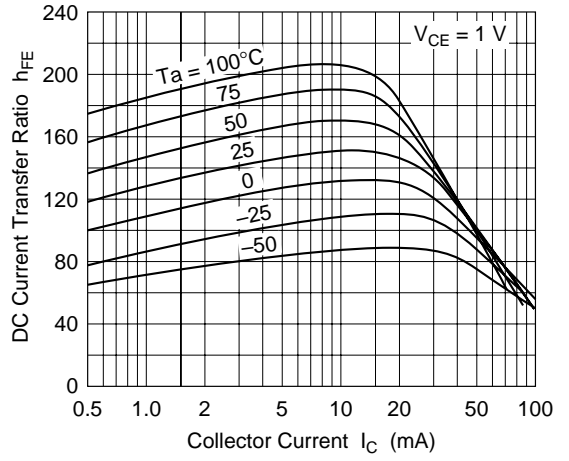

Base to Emitter Saturation Voltage vs. Collector Current

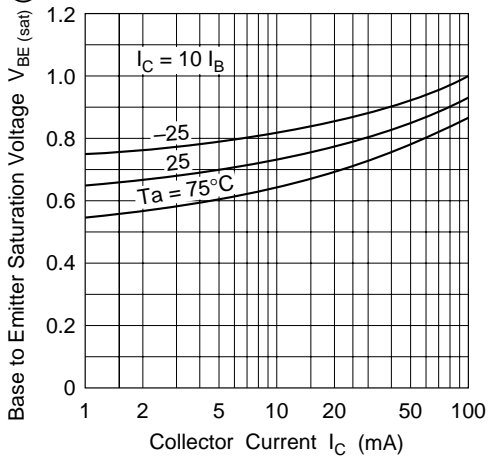

Collector to Emitter Saturation Voltage vs. Collector Current

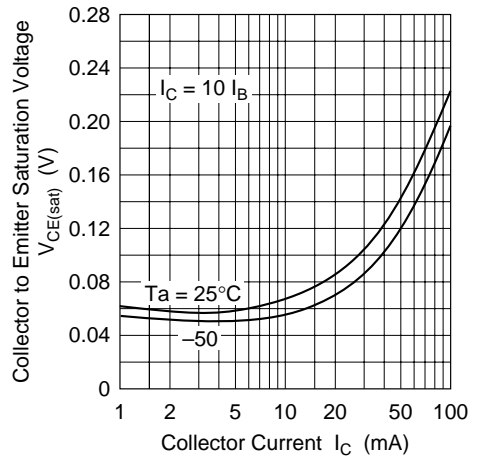

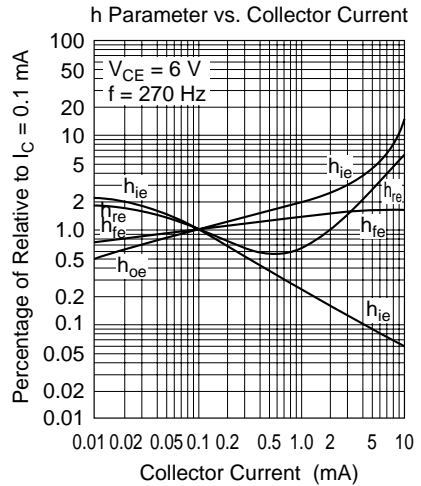
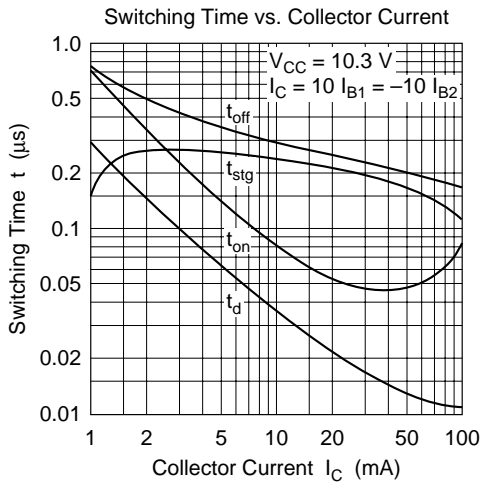
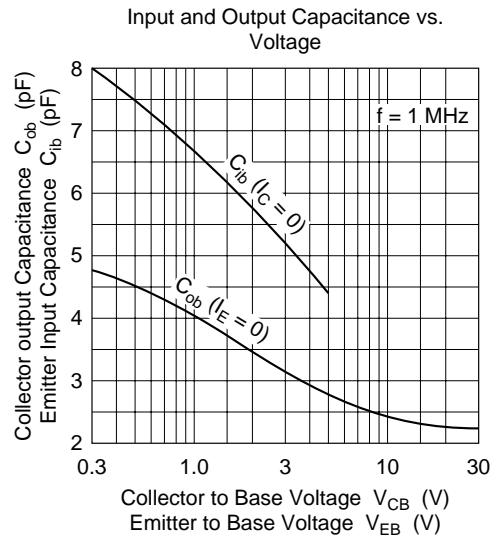
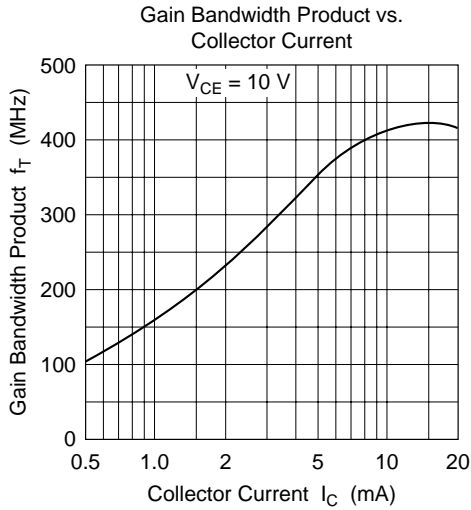

h Parameter vs. Collector to Emitter Voltage

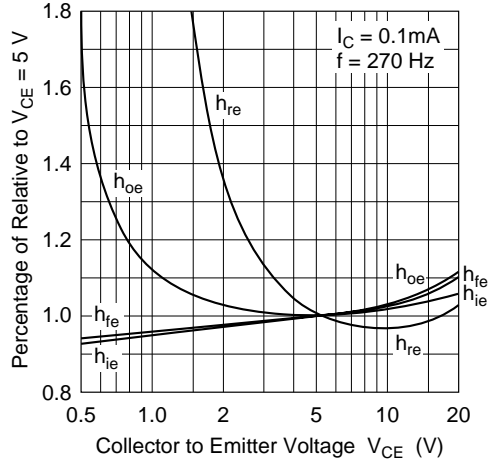

Package Dimensions

As of January, 2001
Unit: mm

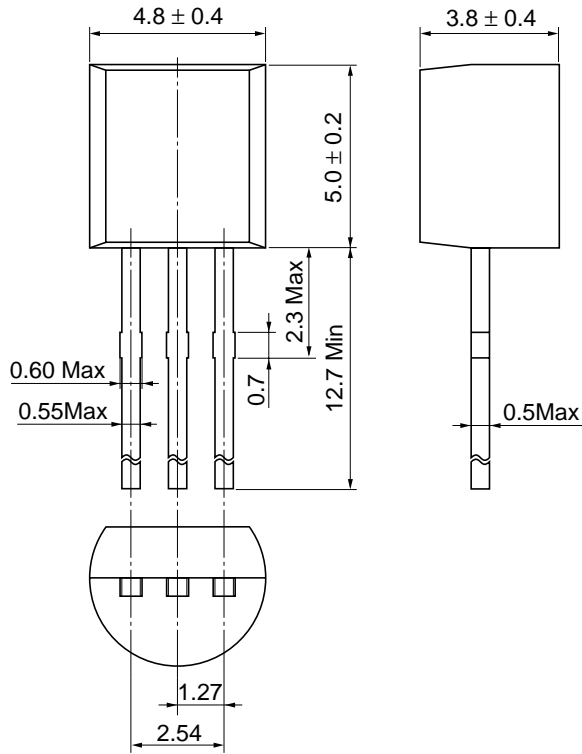

Hitachi Code	TO-92 (1)
JEDEC	Conforms
EIAJ	Conforms
Mass (reference value)	0.25 g

Cautions

1. Hitachi neither warrants nor grants licenses of any rights of Hitachi's or any third party's patent, copyright, trademark, or other intellectual property rights for information contained in this document. Hitachi bears no responsibility for problems that may arise with third party's rights, including intellectual property rights, in connection with use of the information contained in this document.
2. Products and product specifications may be subject to change without notice. Confirm that you have received the latest product standards or specifications before final design, purchase or use.
3. Hitachi makes every attempt to ensure that its products are of high quality and reliability. However, contact Hitachi's sales office before using the product in an application that demands especially high quality and reliability or where its failure or malfunction may directly threaten human life or cause risk of bodily injury, such as aerospace, aeronautics, nuclear power, combustion control, transportation, traffic, safety equipment or medical equipment for life support.
4. Design your application so that the product is used within the ranges guaranteed by Hitachi particularly for maximum rating, operating supply voltage range, heat radiation characteristics, installation conditions and other characteristics. Hitachi bears no responsibility for failure or damage when used beyond the guaranteed ranges. Even within the guaranteed ranges, consider normally foreseeable failure rates or failure modes in semiconductor devices and employ systemic measures such as fail-safes, so that the equipment incorporating Hitachi product does not cause bodily injury, fire or other consequential damage due to operation of the Hitachi product.
5. This product is not designed to be radiation resistant.
6. No one is permitted to reproduce or duplicate, in any form, the whole or part of this document without written approval from Hitachi.
7. Contact Hitachi's sales office for any questions regarding this document or Hitachi semiconductor products.

HITACHI

Hitachi, Ltd.

Semiconductor & Integrated Circuits.
Nippon Bldg., 2-6-2, Ohte-machi, Chiyoda-ku, Tokyo 100-0004, Japan
Tel: Tokyo (03) 3270-2111 Fax: (03) 3270-5109

URL	NorthAmerica	: http://semiconductor.hitachi.com/
	Europe	: http://www.hitachi-eu.com/hel/ecg
	Asia	: http://sicapac.hitachi-asia.com
	Japan	: http://www.hitachi.co.jp/Sicd/indx.htm

For further information write to:

Hitachi Semiconductor
(America) Inc.
179 East Tasman Drive,
San Jose, CA 95134
Tel: <1> (408) 433-1990
Fax: <1> (408) 433-0223

Hitachi Europe GmbH
Electronic Components Group
Dornacher Straße 3
D-85622 Feldkirchen, Munich
Germany
Tel: <49> (89) 9 9180-0
Fax: <49> (89) 9 29 30 00

Hitachi Europe Ltd.
Electronic Components Group.
Whitebrook Park
Lower Cookham Road
Maidenhead
Berkshire SL6 8YA, United Kingdom
Tel: <44> (1628) 585000
Fax: <44> (1628) 585160

Hitachi Asia Ltd.
Hitachi Tower
16 Collyer Quay #20-00,
Singapore 049318
Tel: <65>-538-6533/538-8577
Fax: <65>-538-6933/538-3877
URL: <http://www.hitachi.com.sg>

Hitachi Asia Ltd.
(Taipei Branch Office)
4/F, No. 167, Tun Hwa North Road,
Hung-Kuo Building,
Taipei (105), Taiwan
Tel: <886>-(2)-2718-3666
Fax: <886>-(2)-2718-8180
Telex: 23222 HAS-TP
URL: <http://www.hitachi.com.tw>

Hitachi Asia (Hong Kong) Ltd.
Group III (Electronic Components)
7/F., North Tower,
World Finance Centre,
Harbour City, Canton Road
Tsim Sha Tsui, Kowloon,
Hong Kong
Tel: <852>-(2)-735-9218
Fax: <852>-(2)-730-0281
URL: <http://www.hitachi.com.hk>

Copyright © Hitachi, Ltd., 2000. All rights reserved. Printed in Japan.
Colophon 2.0