

# HA11225

## FM IF System

The HITACHI HA11225 is an FM IF Amplifier and Detector developed for HI FI Tuners. This IC is encapsulated in DIP-16 pin.

### FUNCTIONS

- FM IF Amplifier
- Quadrature Detector
- Audio Amplifier
- Muting Circuit
- AFC, Tuning Meter Driver
- AGC Control Voltage Generator
- Muting Control Voltage Generator
- Signal Meter Driver

### FEATURES

Many on-chip functions as above will result in smaller-sized sets, eliminate restriction in designing, and save labor.

- Low Distortion: 0.03% typ.
- High Signal-to-Noise Ratio: 84dB typ.
- High Limiting Sensitivity: 31dB $\mu$  typ.
- Large Muting Attenuation: 85 dB typ.
- Provides specific signal for direct drive of a signal meter with good linearity

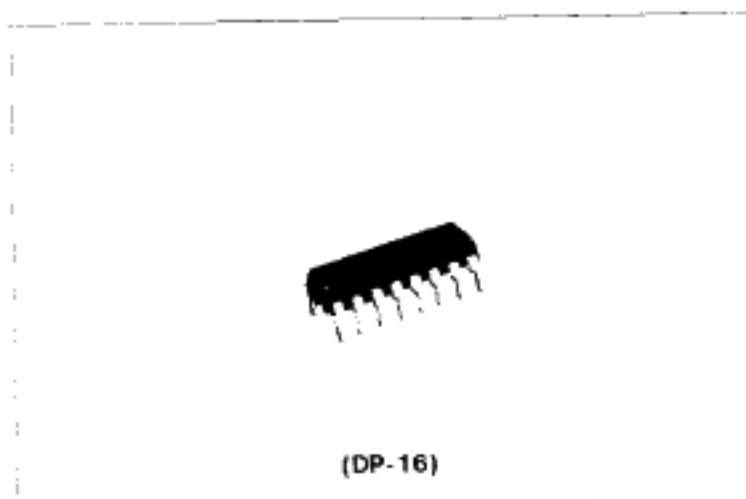

(DP-16)

- Muting level is variable by adjusting the external resistor connected to pin 16.
- High stability against abnormal oscillation.

Note) 1. Testing conditions: Input=100dB $\mu$ , fm=400Hz, f=75kHz, fc=10.7MHz

2. This IC is compatible with the HA1137W except pin 16 (pin for muting level adjustment).

### BLOCK DIAGRAM

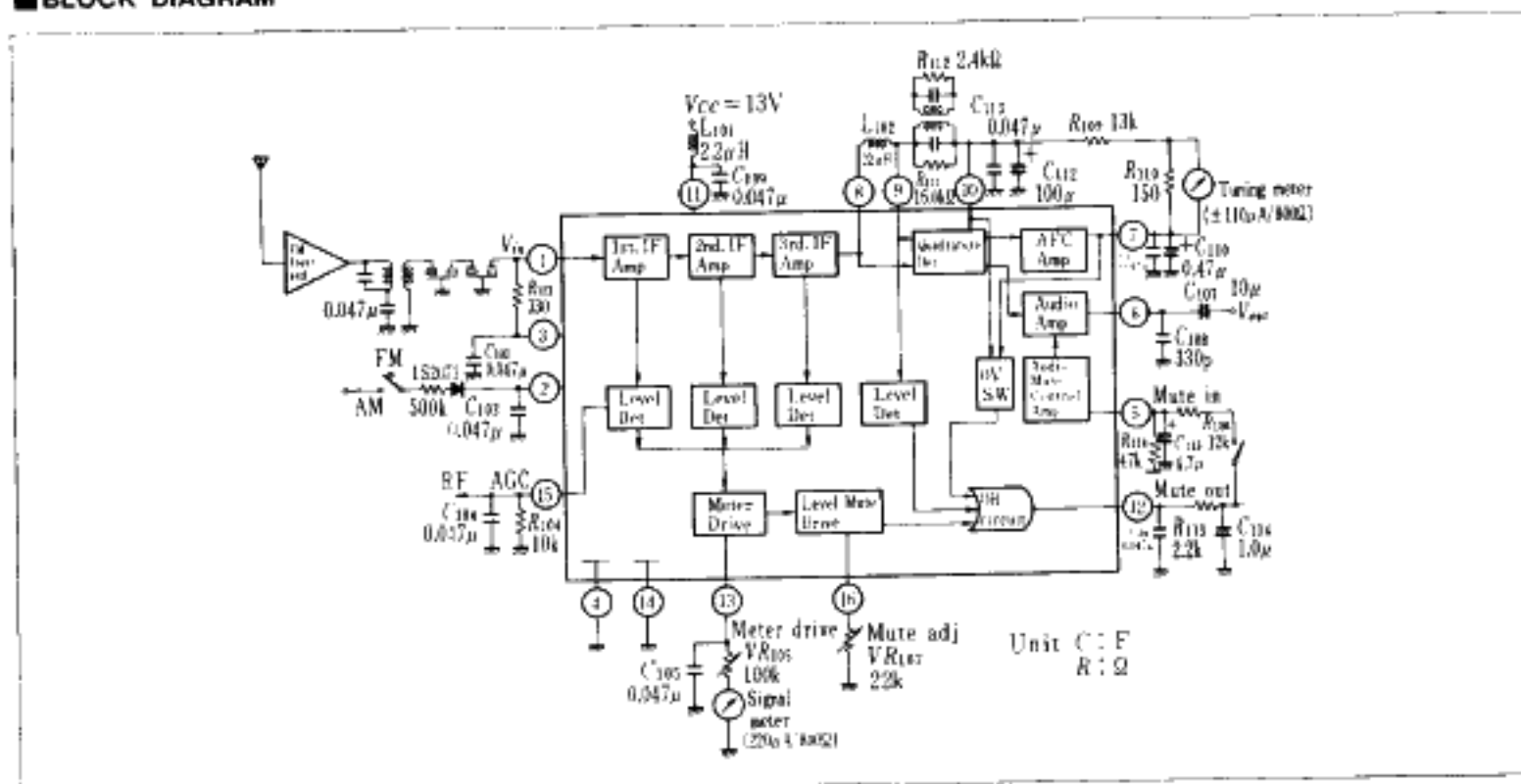

### ABSOLUTE MAXIMUM RATINGS

Item	Symbol	Rating	Unit
Supply Voltage	$V_{cc}$	14	V
Power Dissipation*	$P_T$	590	mW
Operating Temperature	$T_{op}$	-20 to +60	°C
Storage Temperature	$T_{stg}$	-55 to +125	°C

## ELECTRICAL CHARACTERISTICS ( $T_a=25^\circ\text{C}$ )

### ● Static (DC) Characteristics ( $V_{CC}=13\text{V}$ , no signal)

Item	Symbol	Rating			Unit
		min.	typ.	max.	
Pin 1 Voltage	$V_1$	—	1.95	—	V
Pin 2 Voltage	$V_2$	—	1.95	—	V
Pin 3 Voltage	$V_3$	—	1.95	—	V
Pin 6 Voltage	$V_6$	—	5.60	—	V
Pin 7 Voltage	$V_7$	—	5.60	—	V
Pin 10 Voltage	$V_{10}$	—	5.60	—	V

### ● AC Characteristics ( $V_{CC}=13\text{V}$ , $f_c=10.7\text{MHz}$ , $f_m=400\text{Hz}$ , $\Delta f=75\text{kHz dev.}$ )

Item	Symbol	Test Condition	min.	typ.	max.	Unit
Supply Current	$I_{CC}$	$V_{in}=0\text{dB}\mu$ , Pin 16 to Ground open	16	25	33	mA
Limiting Sensitivity	$V_{in}(\text{lim})$	$V_{in}=100\text{dB}\mu$ input, Input level $-3\text{dB}$ from $V_{O(AFP)}$	—	31	37	$\text{dB}\mu$
Recovered AF Voltage	$V_{O(AFP)}$	$V_{in}=100\text{dB}\mu$	265	380	510	$\text{mV}_{\text{rms}}$
Total Harmonic Distortion	T.H.D	$V_{in}=100\text{dB}\mu$	—	0.03	0.10	%
Signal-to-noise Ratio	S/N	$V_{in}=100\text{dB}\mu$	78	84	—	dB
AM Rejection Ratio	AMR	$V_{in}=100\text{dB}\mu$ , AM: $f_m=1\text{kHz}$ , Mod. 30%	45	54	—	dB
Muting Attenuation	Mute <sub>(ATT)</sub>	$V_{in}=100\text{dB}\mu$ , Output standard with pin 5 open, Attenuation with 2V impressed to pin 5	70	85	—	dB
Muting Bandwidth	BW(Mute)	$V_{in}=100\text{dB}\mu$ , Sum of + and - side $\Delta f$ for $V_{12}=1.4\text{V}$	55	105	145	kHz
Muting Sensitivity	$V_{in}(\text{Mute})$	No muting level adjustment (pin 16 open), Input level for $V_{12}=1.4\text{V}$	36	44	60	$\text{dB}\mu$
Muting Sensitivity Adjustment Range	$AV_{in}(\text{Mute})^*$	Max. input level with possible muting level adjustment	75	—	—	$\text{dB}\mu$
Meter Drive Voltage (1)	$V_{12-1}$	$V_{in}=0\text{dB}\mu$ , Pin 13 voltage	—	0	—	V
Meter Drive Voltage (2)	$V_{12-20}$	$V_{in}=70\text{dB}\mu$ , Pin 13 voltage	0.9	1.45	—	V
Meter Drive Voltage (3)	$V_{12-30}$	$V_{in}=100\text{dB}\mu$ , Pin 13 voltage	4.7	5.2	—	V
AGC Control Voltage	$V_{15}$	$V_{in}=86\text{dB}\mu$ , Pin 15 voltage	—	4.3	—	V

\* Muting level can be adjusted up to  $75\text{dB}\mu$  and should be set within this range.

## TEST CIRCUIT

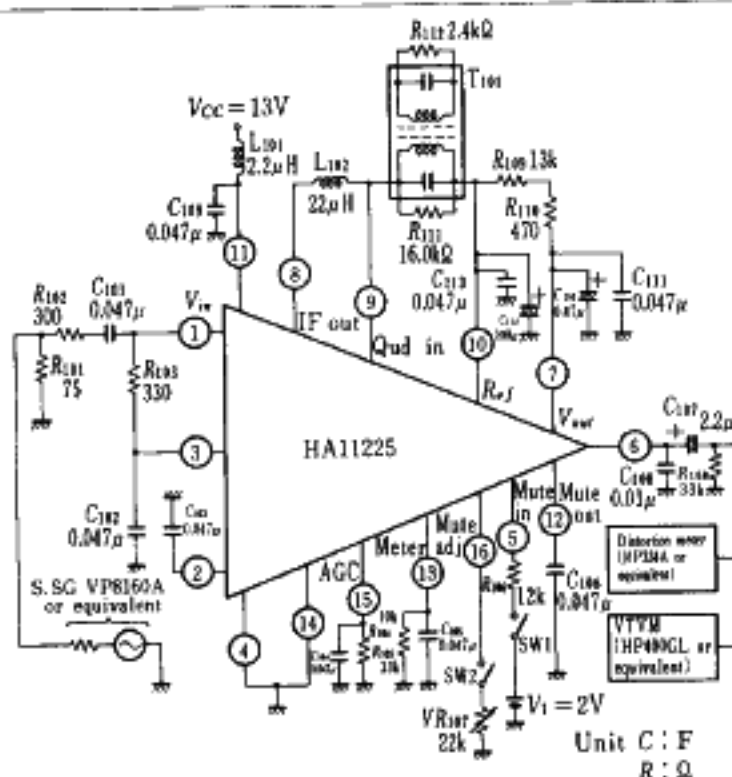

### Notes:

- SW1: on when testing muting attenuation, off for other items.
- SW2: on when testing muting sensitivity adjustment range, off for other items.

Unit C : F  
R :  $\Omega$

■ CHARACTERISTICS

The following characteristics have been achieved by giving careful consideration to the designing.

● FM IF Amp/Detector

Requirements for high performance FM tuners are satisfied by high S/N, low THD, and wide low-THD bandwidth.

The signal-to-noise ratio has reached 84dB typ; the HA11225 is designed for minimizing FM-demodulated noise (converted at the quadrature detector) and audible noise of the post stage audio amp.

Also, the optimized design in 90° phase-shift circuit has brought out low THD of 0.03% typ ( $V_{in}=65\sim 120dB\mu$ ) and wide low-THD bandwidth of 10.7MHz±80kHz (THD=0.1%)

In contrast to the conventional ones, this IC has removed the pin-9 IF output signal detection used for muting. The detection independent muting operation can eliminate much restriction in designing a phase shift transformer.

● Audio Muting Section

Muting under weak-input or detuning is allowed by applying mute control voltage into pin-5 from pin-12.

Internal crosstalk of audio signal is minimized by connecting an external 100μF to pin-10 to obtain a large muting attenuation of 85dB typ. The 100μF capacitor also contributes to S/N improvement.

● Muting Control/Driver

Muting function starts at 44dB typ of input voltage when pin-16 is open (i.e.,  $R_{107}=\infty$ ). Therefore by simply changing an external resistor at pin-16, the mute starting point can be adjusted up to 75dBμ. This feature enables low noise stereo reception.

Even when the mute starting point is set variable by controlling  $VR_{107}$  (an external resistor at pin-16), the circuit will not cause any temperature dependent problems.

■ EXTERNAL COMPONENTS

Parts No.	Recommended Value	Purpose	Influence		Remarks
			Smaller than Recommended value	Larger than Recommended value	
$R_{103}$	330Ω	Impedance matching with ceramic filter	—	—	—
$R_{104}$	10kΩ	Normal operation of AGC	Increase in current consumption	—	—
$VR_{105}$	100kΩ	Adjustment of signal meter sensitivity	—	—	Semifixed resistor
$R_{106}$	12kΩ	Smoothing $C_{115}$ and muting control voltage	Lower time constant	Larger time constant	Measure to reduce pop noise during muting (smooths waveform)
$VR_{107}$	22kΩ	Operation level of level muting	—	—	Semifixed resistor
$R_{109}$	13kΩ	Determination of size of AFC voltage and muting bandwidth	Lower AFC voltage, Wider muting bandwidth	Larger AFC voltage, Narrower muting bandwidth	$R_{109}$ and $C_{110}$ make up low pass filter. If $R_{109}$ changes, $C_{110}$ will also change so that $R_{109} \times C_{110}$ remains constant.
$R_{110}$	150Ω	Adjustment of tuning meter sensitivity	Drop in tuning meter sensitivity	Improved tuning meter sensitivity	—
$R_{111}$	16kΩ	Damping of phase shifter (primary side)	Increased T.H.D, Large voltage left in pin 12.	Increased T.H.D	—
$R_{112}$	2.4kΩ	Damping of phase shifter (secondary side)	Increased T.H.D	Increased T.H.D	—
$R_{113}$	2.2kΩ	Smoothing $C_{114}$ and muting control voltage, Determination of muting (time constant)	Lower time constant	Larger time constant	For prevention of chattering of pin 12 voltage.
$C_{102}$ $C_{103}$	0.047μF	Bypass capacitor	Poorer FM IF frequency stability	—	Use capacitor with good high frequency characteristics.
$C_{104}$	0.047μF	Smoothing of AGC voltage	IF frequency(10.7MHz) left in AGC voltage	—	—
$C_{105}$	0.047μF	Bypass capacitor	Increased T.H.D near meter response	—	—
$C_{106}$	0.047μF	Bypass capacitor	Poorer FM IF frequency stability	—	—
$C_{107}$	10μF	Coupling capacitor for detector output	Cut of low bands	—	—

(to be continued)

Parts No.	Recommended Value	Purpose	Influence		Remarks
			Smaller than Recommended value	Larger than Recommended value	
C <sub>108</sub>	330 pF	Bypass capacitor	High frequency pass of output pin 6 changes, oscillation must be checked	—	C <sub>108</sub> =0.01 μF at test circuit
C <sub>109</sub>	0.047 μF × 2	Decoupling of L <sub>101</sub> power supply	Reduced decoupling effect	—	—
C <sub>110</sub>	0.47 μF	Bypass capacitor (Low frequency)	—	Slower AFC voltage response	Use both C <sub>110</sub> and C <sub>111</sub>
C <sub>111</sub>	0.047 μF	Bypass capacitor (High frequency)	—	—	
C <sub>112</sub>	100 μF	Bypass capacitor (Low frequency)	Poorer S/N	Deterioration of IC by large current flowing when charging	—
C <sub>113</sub>	0.047 μF	Bypass capacitor (High frequency)	—	—	—
C <sub>114</sub>	1.0 μF	Smoothing R <sub>113</sub> and muting control voltage	Error in muting by AC part of muting control voltage	Slower muting response	—
C <sub>115</sub>	4.7 μF	Smoothing R <sub>106</sub> and muting control voltage	Error in muting by AC part of muting control voltage	Slower muting response	—
L <sub>101</sub>	2.2 μH	Decoupling C <sub>115</sub> and power supply	—	—	Use one with good high frequency characteristics. Note vibration stability.
L <sub>102</sub>	22 μH	Detector phase shifter coil	Normal detector characteristics not obtained, Large voltage left in pin 12	Normal detector characteristics not obtained	—

■ PC-BOARD LAYOUT PATTERN

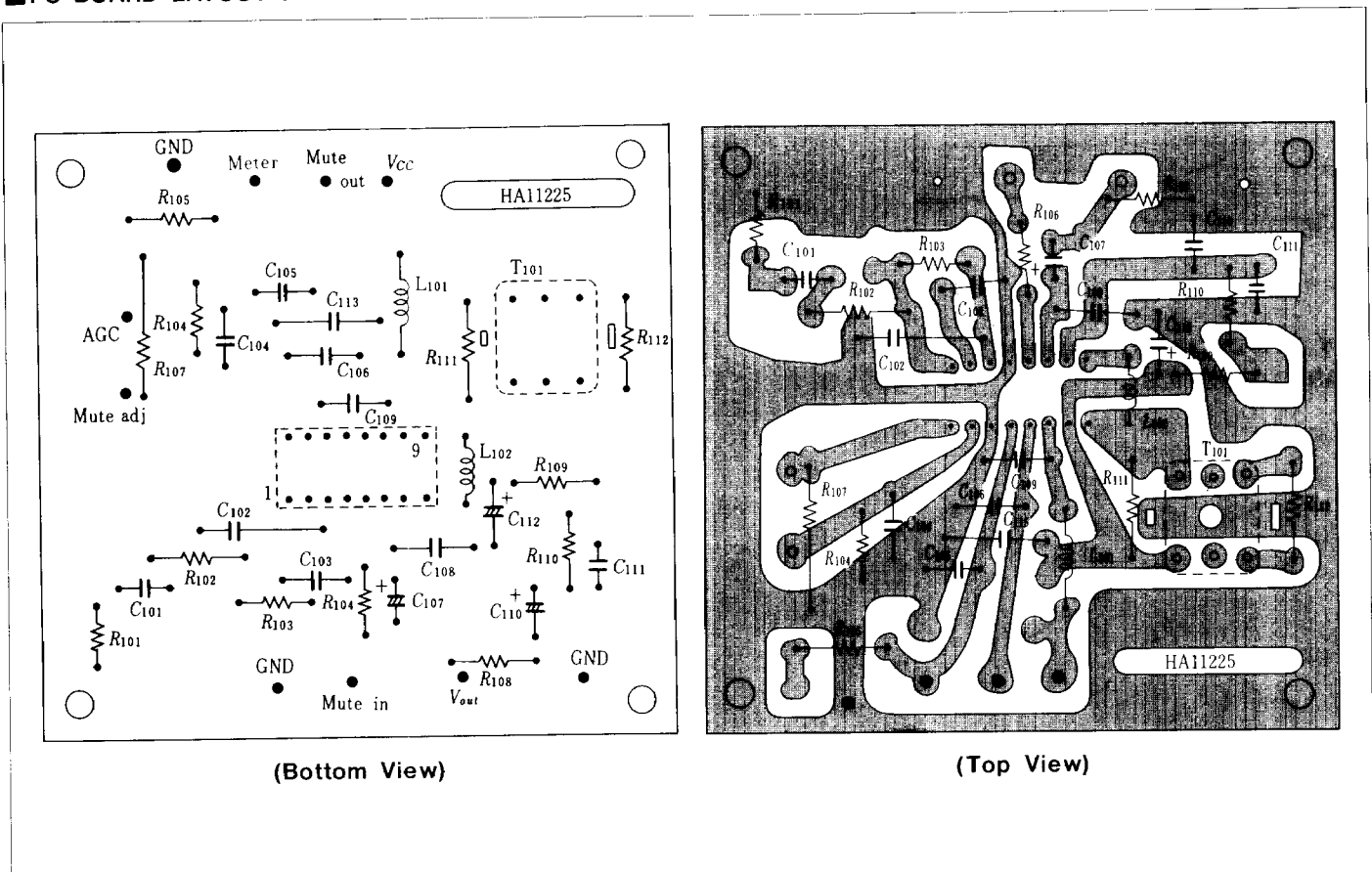

**DETECTOR OUTPUT, SIGNAL-TO-NOISE RATIO AND AM REJECTION VS. INPUT VOLTAGE**

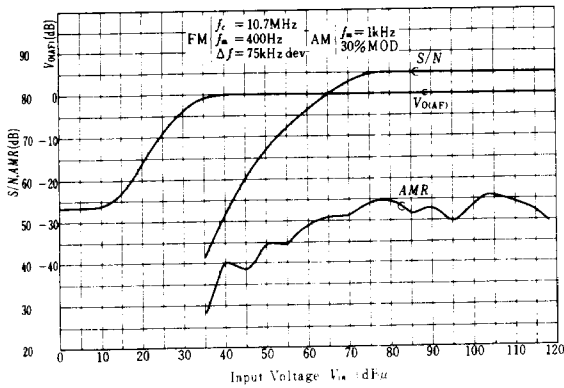

**MUTE CONTROL VOLTAGE, AGC CONTROL VOLTAGE AND METER DRIVE VOLTAGE VS. INPUT VOLTAGE**

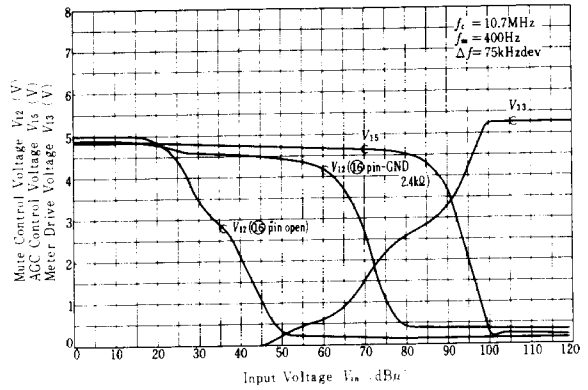

**TOTAL HARMONIC DISTORTION VS. INPUT VOLTAGE**

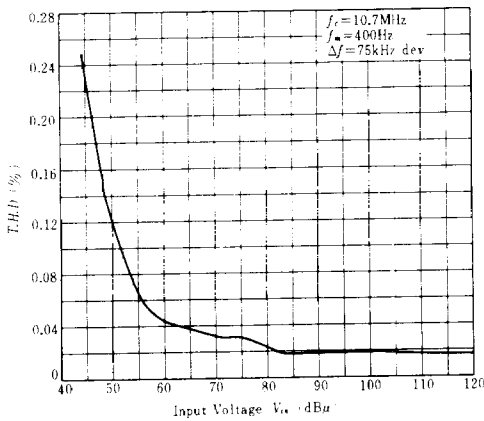

**AFC VOLTAGE VS. INPUT VOLTAGE**

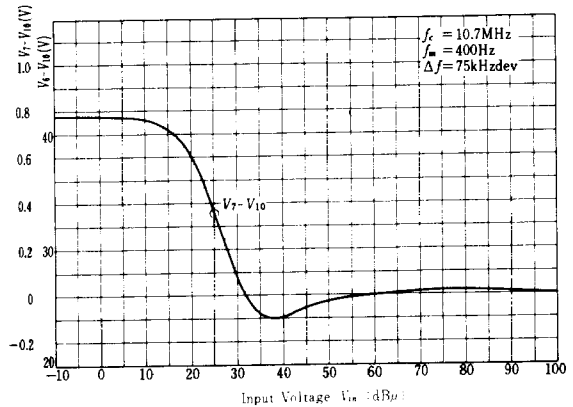

**V7-V10, V12 DETUNING FREQUENCY CHARACTERISTICS**

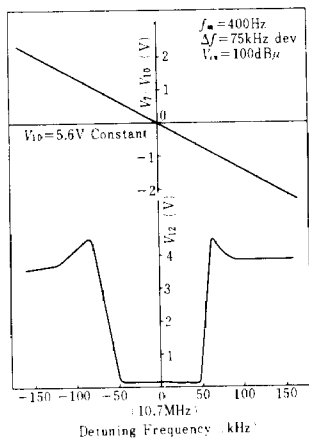

**TOTAL HARMONIC DISTORTION VS. DETUNING FREQUENCY**

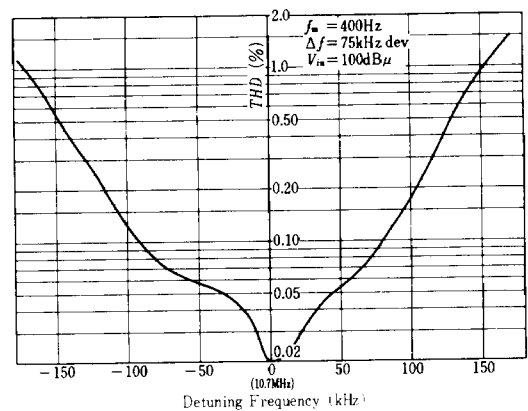

**OUTPUT VOLTAGE AND TOTAL HARMONIC DISTORTION VS. MODULATION FREQUENCY**

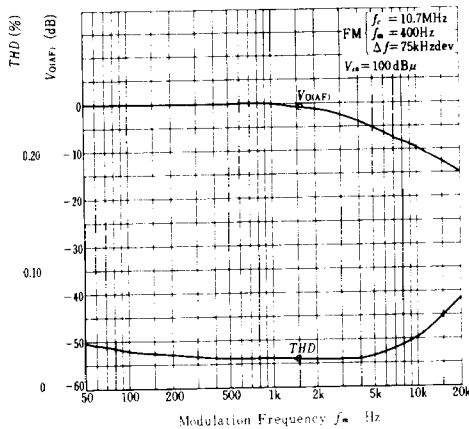

**INPUT VOLTAGE VS. SUPPLY VOLTAGE**

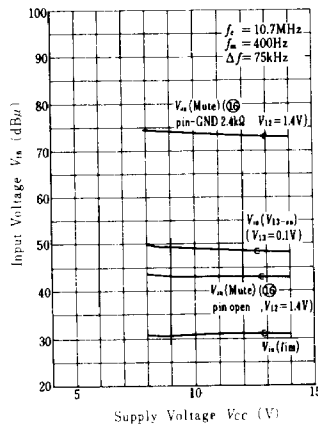

**MUTE ATTENUATION, OUTPUT VOLTAGE, AM REJECTION RATIO AND SUPPLY CURRENT VS. SUPPLY VOLTAGE**

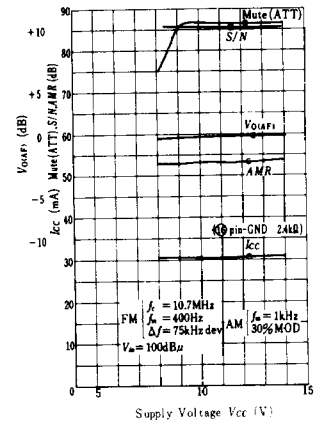

**MUTING BANDWIDTH,  $V_7-V_{10}$  AND TOTAL HARMONIC DISTORTION VS. SUPPLY VOLTAGE**

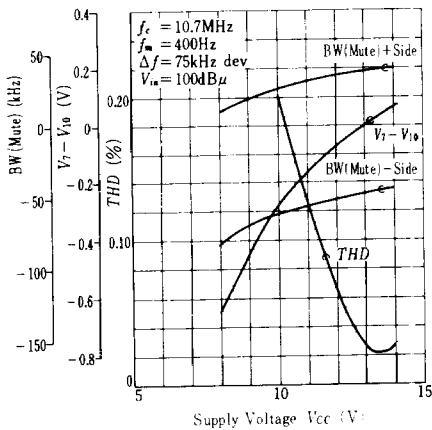

**MUTE ATTENUATION, SIGNAL-TO-NOISE RATIO, AM REJECTION RATIO AND OUTPUT VOLTAGE VS. AMBIENT TEMPERATURE**

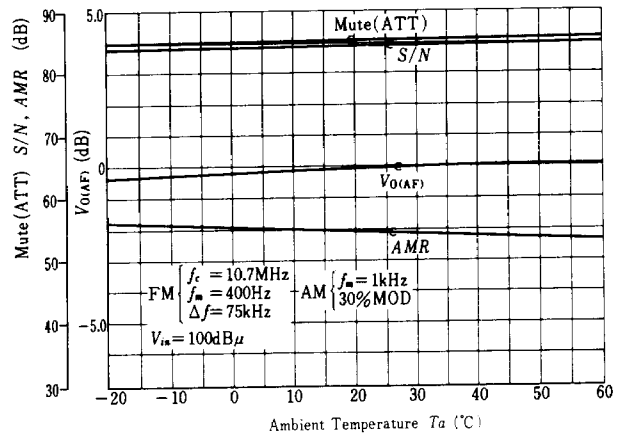

**BANDWIDTH AND TOTAL HARMONIC DISTORTION VS. AMBIENT TEMPERATURE**

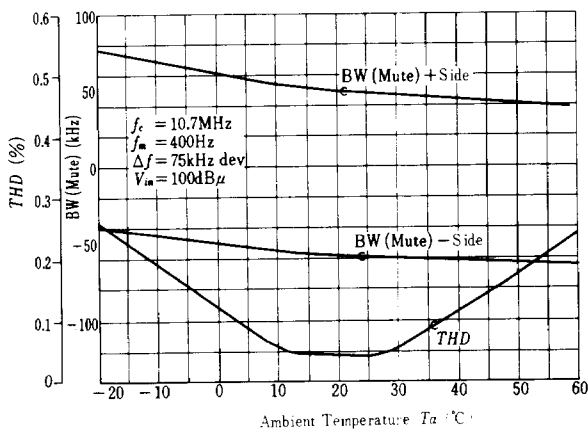

**INPUT VOLTAGE VS. AMBIENT TEMPERATURE**

