

# HA17431

## Adjustable Precision Shunt Regulator

### Description

HA17431 is a temperature-compensated, three terminal adjustable regulator. Output voltage value can be set in the range of  $V_{ref}$  (about 2.5V) to 40V with the two external resistors,  $R_1$  and  $R_2$ , shown in figure 1. Dynamic output impedance is  $0.2\Omega$  when the frequency is 1KHz or less, which shows the very sharp turn-on characteristic of the HA17431. It can be used not only as a precision power supply but also as a replacement for the simple zener diode.

### Features

- Internal temperature-compensated reference voltage (50ppm/°C typ.)
- Low quiescent current (400 $\mu$ A typ.)
- SINK current (1mA to 100mA)
- Wide output voltage range ( $V_{ref}$  to 40V)

### Ordering Information

Type No.	Package
HA17431UA	U-PAK
HA17431FP	FP-8D
HA17431PS	DP-8

### Block Diagram

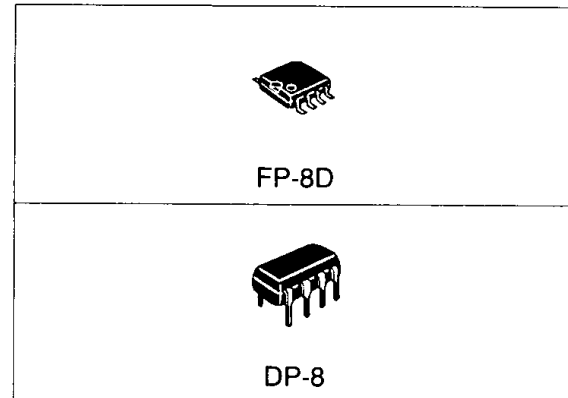
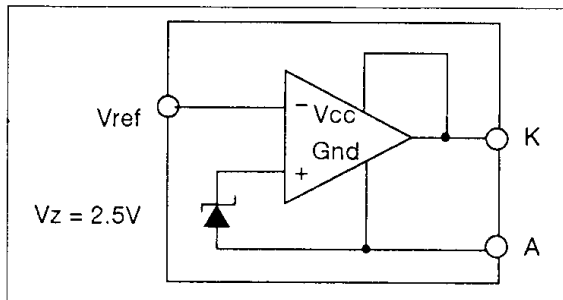

### Pin Arrangement

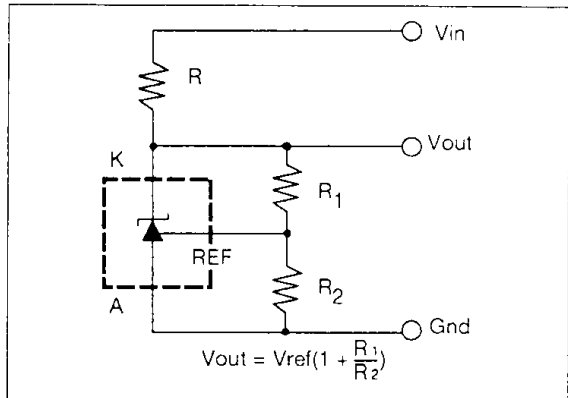
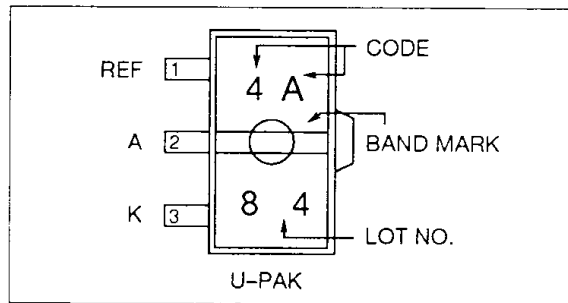

Figure 1.

**Absolute Maximum Ratings (Ta = 25°C)**

Item	Symbol	HA17431	Unit
Cathode Voltage	VKA	40	V
Continuous Cathode Current	Ik	-100 to +150	mA
Reference Input Current	Iref	-0.05 to +10	mA
Power Dissipation	PT	800*	mW
Operating Temperature	Topr	-20 to +85	°C
Storage Temperature	Tstg	-55 to +150	°C

The absolute maximum ratings are limiting values, to be applied individually, beyond which the device may be permanently damaged. Functional operation under any of these conditions is not guaranteed. Exposing a circuit to its absolute maximum rating for extended periods of time may affect the device's reliability.

\* The value under Ta = 25°C when mounted on a 15mm x 25mm x 0.7mm alumina ceramic board.

**Power Dissipation Curve**

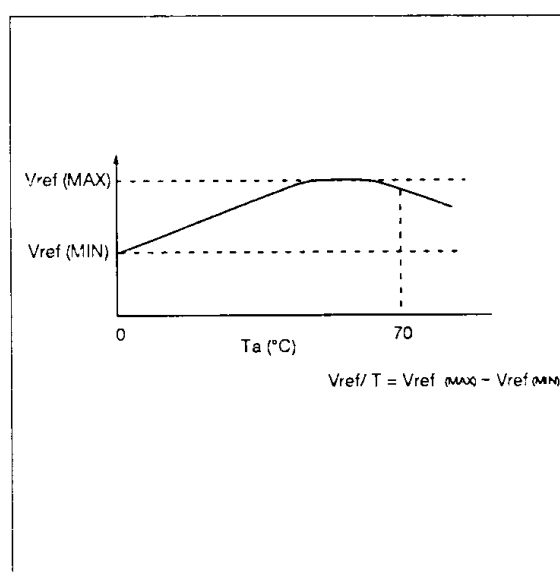
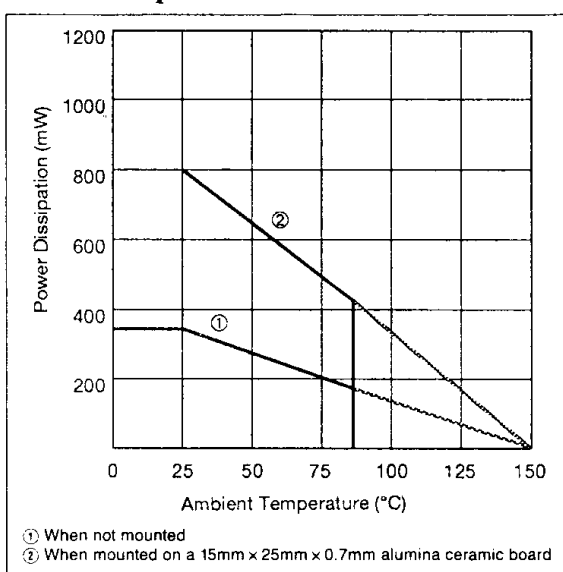

**Electrical Characteristics (Ta = 25°C)**

Item	Symbol	Test Condition	min.	typ.	max.	Unit
Reference Voltage	Vref	VKA = Vref, Ik = 10mA	2.440	2.495	2.550	V
Reference Voltage Temperature	$\Delta V_{ref}/\Delta T$	VKA = Vref, Ik = 10mA, Ta = 0 ~ 70°C	—	5	(17)*	mV
Reference Voltage Change	$\Delta V_{ref}/\Delta V_{KA}$	Ik = 10mA, $\Delta V_{KA} = 10V - V_{ref}$ $\Delta V_{KA} = 40V - 10V$	—	1.4 1	3.7 2.2	mV /V
Reference Input Current	Iref	Ik = 10mA, R1 = 10k $\Omega$ , R2 = $\infty$	—	2	6	$\mu A$
Reference Input Current Temperature Drift	$\Delta I_{ref}/\Delta T$	Ik = 10mA, R1 = 10k $\Omega$ , R2 = $\infty$ , Ta = 0 ~ 70°C	—	0.5	—	$\mu A$
Minimum Cathode Current	Imin	VKA = Vref	—	0.4	1	mA
Off Cathode Current	Ioff	VKA = 40V, Vref = 0V	—	0.001	1	$\mu A$
Dynamic Impedance	ZKA	VKA = Vref, Ik = 1-100mA, f $\leq$ 1KHz	—	0.2	0.5	$\Omega$

\*The maximum value of the reference voltage temperature ( $\Delta V_{ref}/\Delta T$ ) is designed value.



Typical Applications

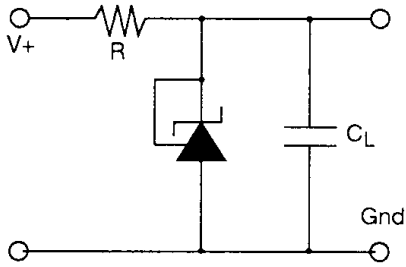

Reference Voltage Circuit

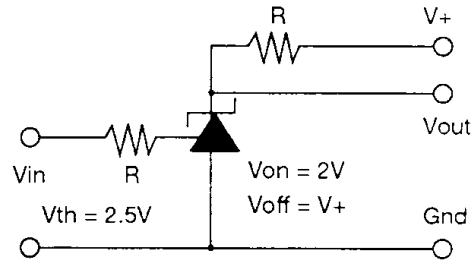

Single Supply Comparator

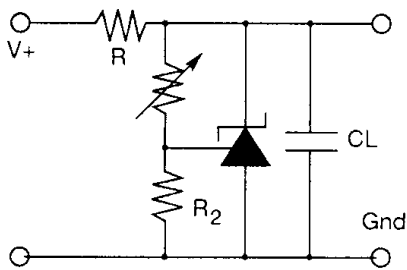

Shunt Regulator

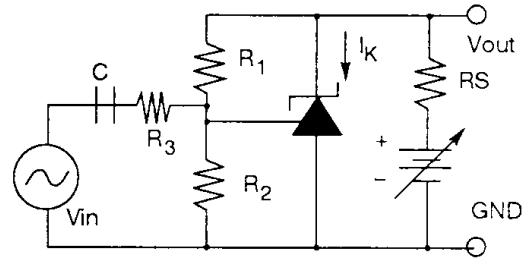

AC Amplifier Circuit

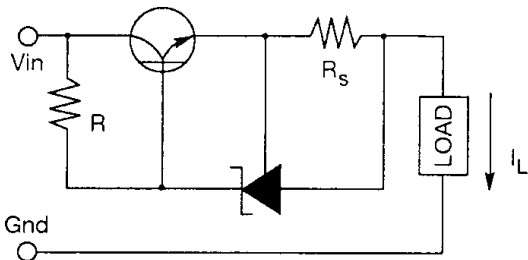

Current Limiter or Current Source

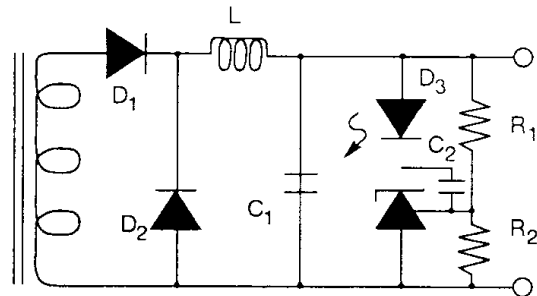

Error Amplifier Circuit

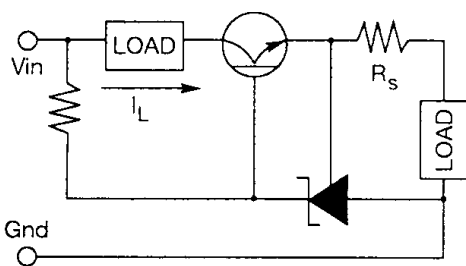

Current Liniter or Current Source

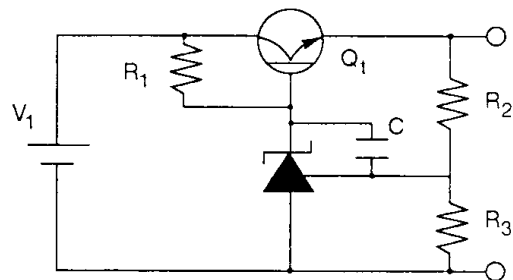

Constant Voltage Circuit

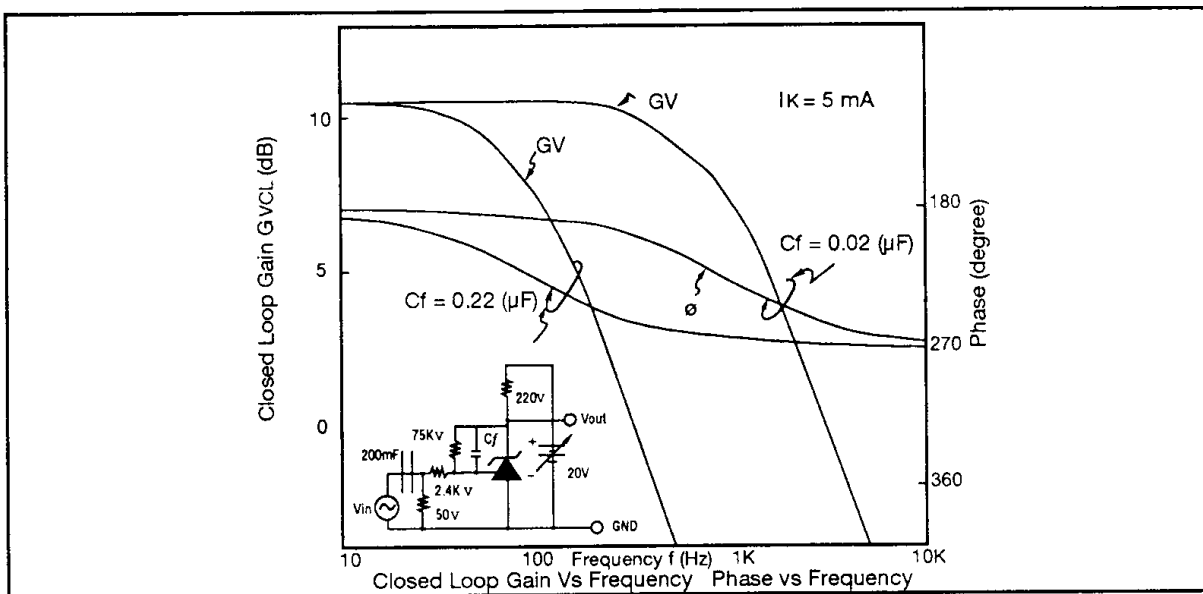
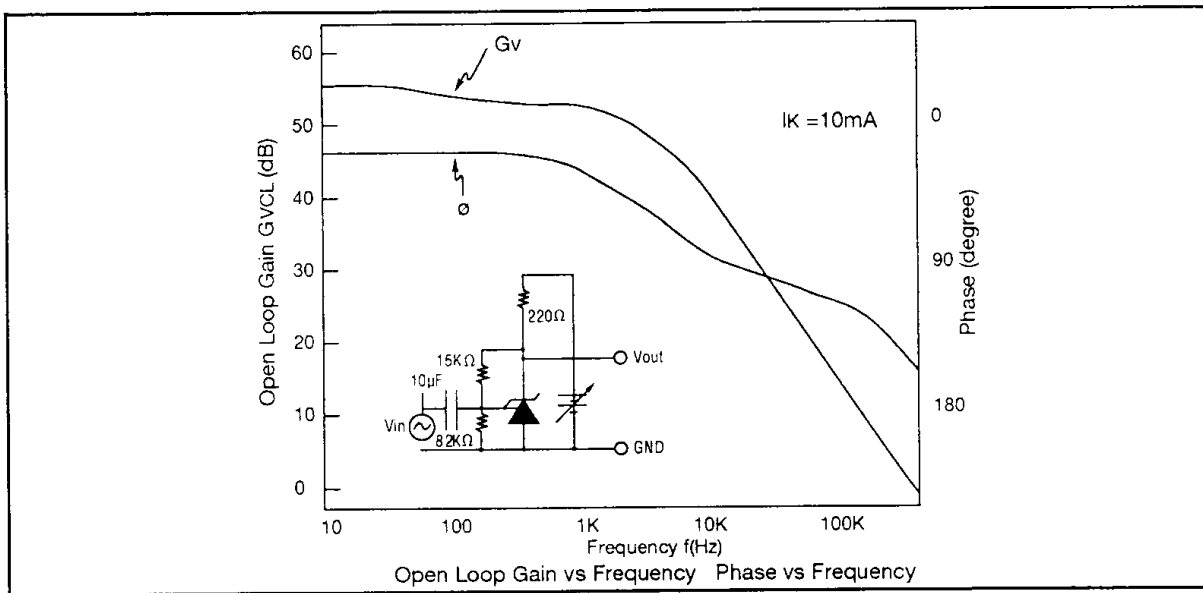
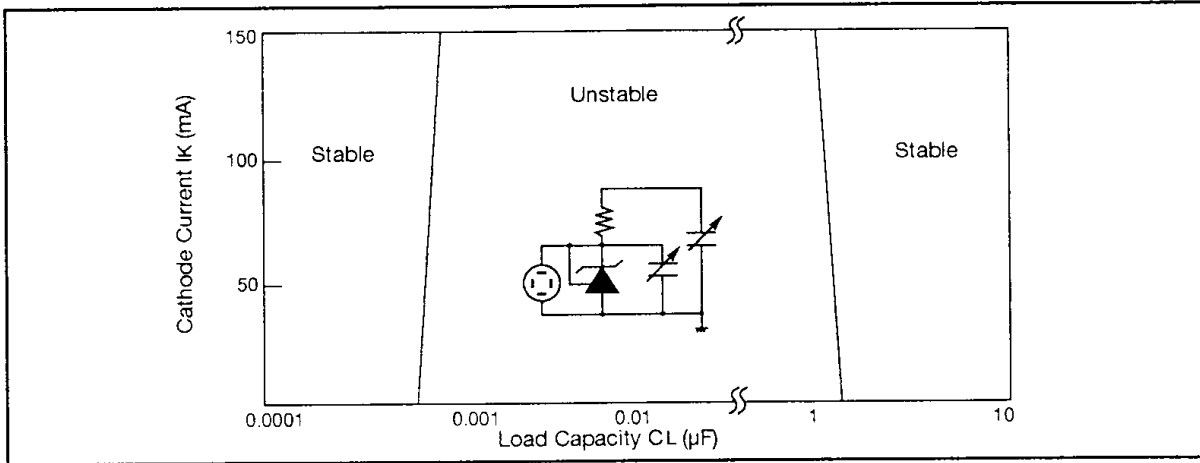

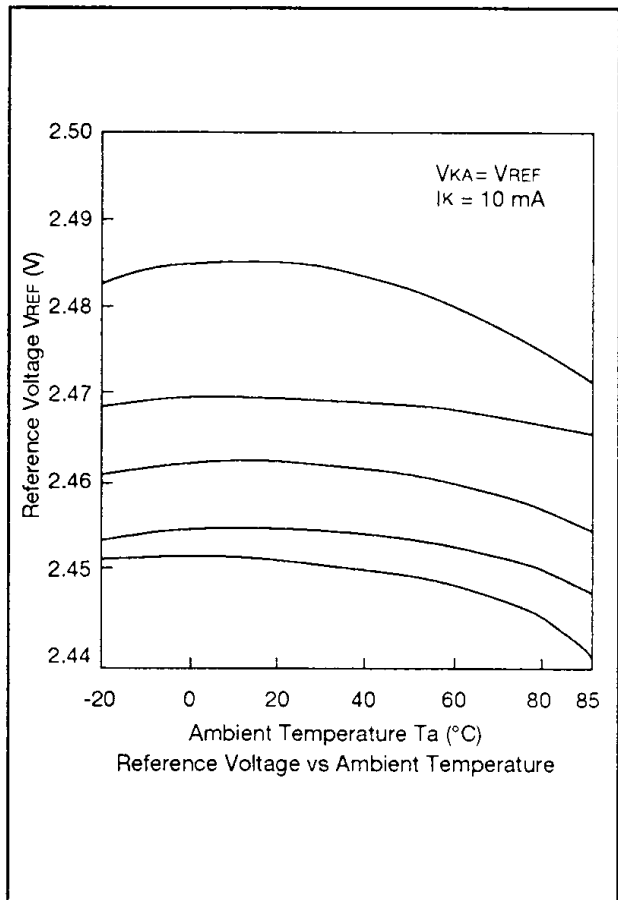
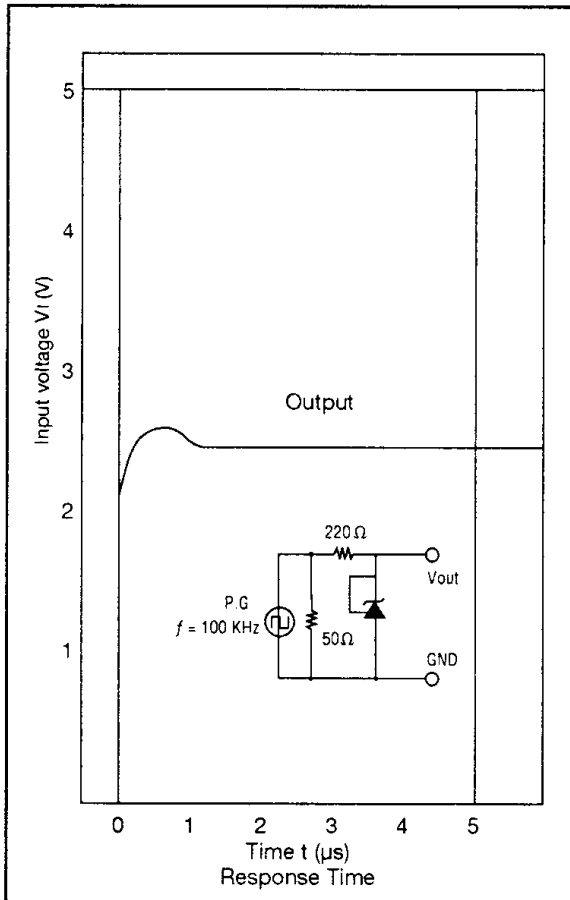
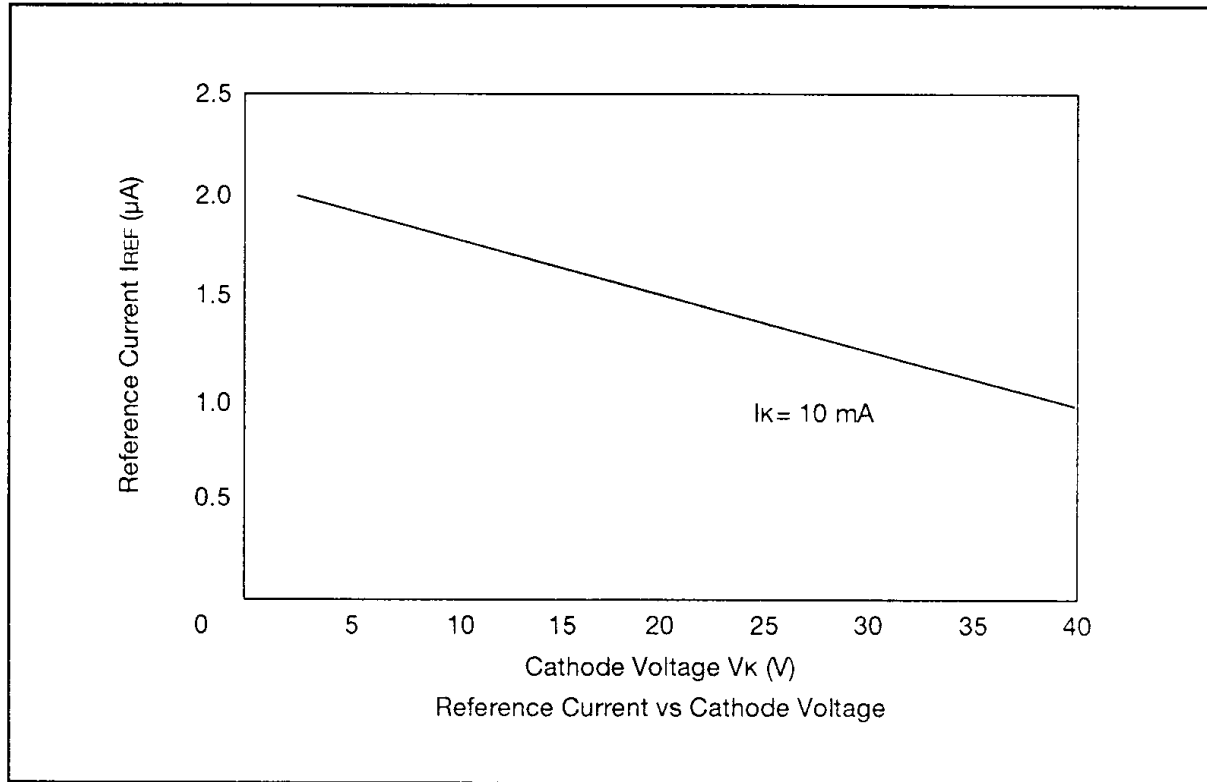

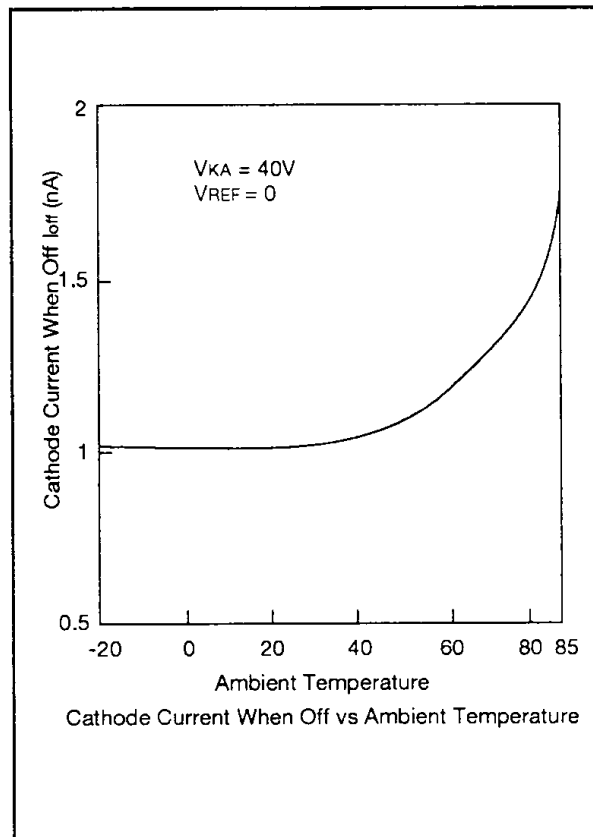
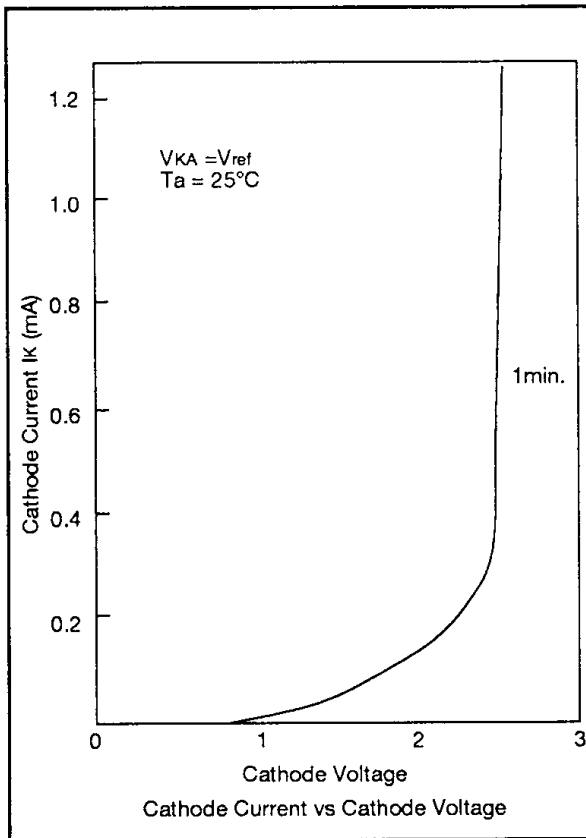
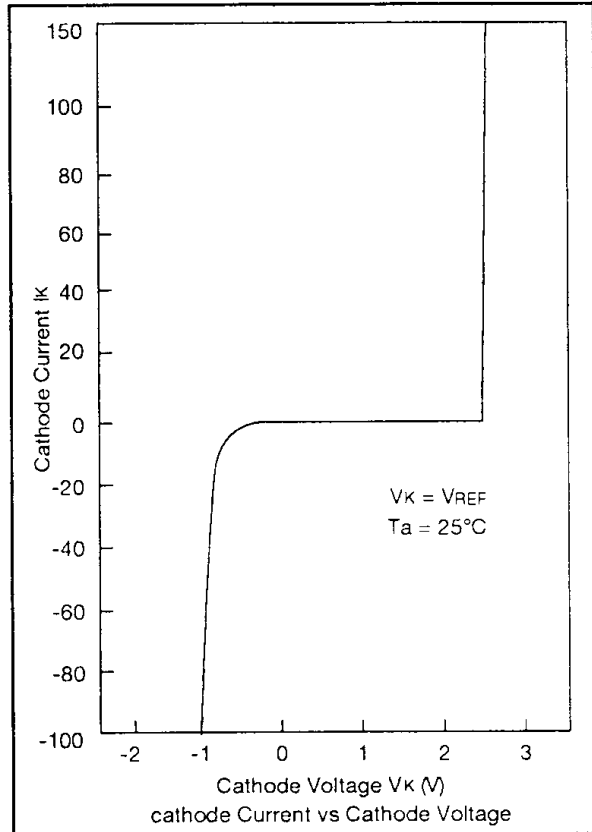
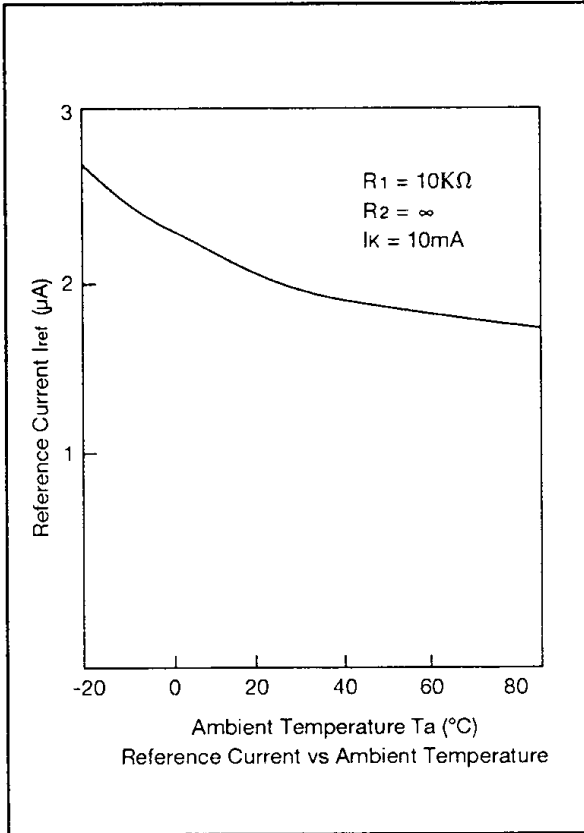

**Solder Mounting Method**

1). Small and light surface-mount packages require special attentions on solder mounting. On solder mounting, pre-heating before soldering is needed. The following figure shows an example of infrared rays reflow.

2). The difference of thermal expansion coefficient between mounting substrates and IC lead may cause a failure like solder peeling or solder wet, and electrical characteristics may change by thermal stress. Therefore, mounting should be done after sufficient confirmation for especially in case of ceramic substrates.

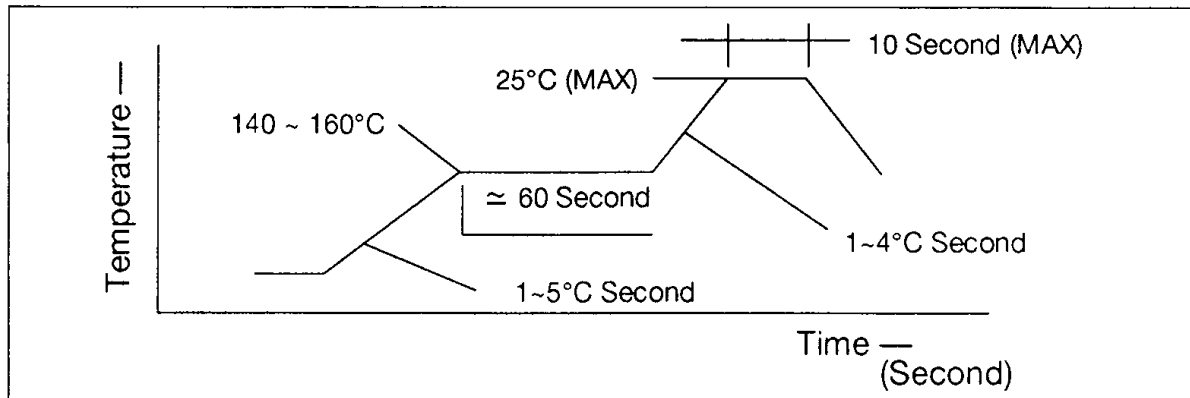

**An Example of Infrared Rays Reflow Conditions**