

FM STEREO MULTIPLEX DECODER

The KA2261 is a monolithic integrated circuit consisting of a phase locked loop FM stereo demodulator. It was designed for use in car stereos, cassette recorders and other equipment.

FEATURES

- A PLL is used for high multiplexing performance.
- Wide operating supply voltage range: $V_{CC} = 3V - 14V$
- Low quiescent circuit current ($I_{CCQ} = 8.5mA$, Typ).
- High SCA rejection ratio.
- High channel separation (45dB, Typ) and can be controlled by an external resistor.
- Built-in VCO disable and monaural muting circuits.
- Built-in stereo indicator lamp drive circuit.

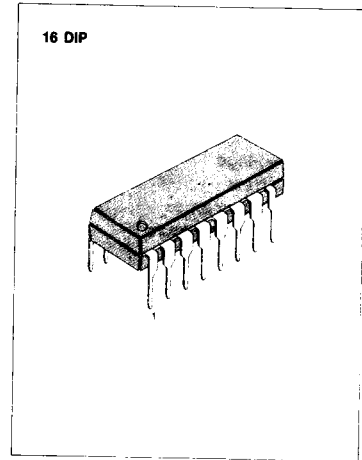

ORDERING INFORMATION

Device	Package	Operating Temperature
KA2261	16 DIP	-20°C ~ +70°C

BLOCK DIAGRAM

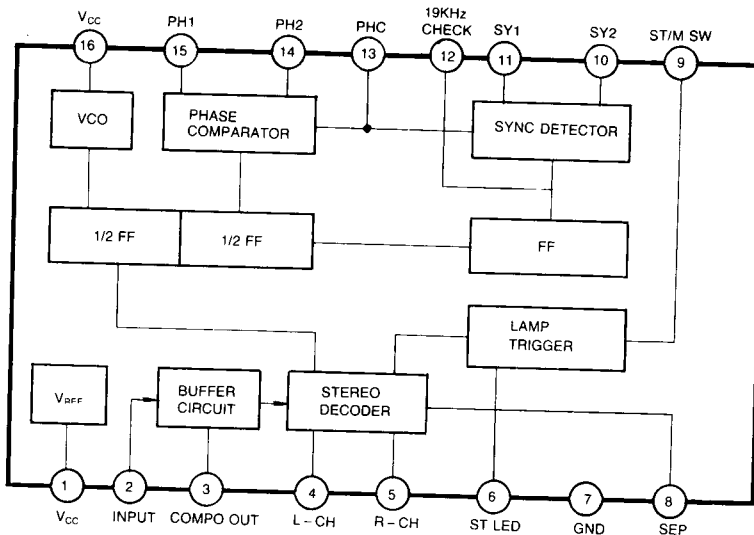

Fig. 1.

ABSOLUTE MAXIMUM RATINGS ($T_a = 25^\circ\text{C}$)

Characteristic	Symbol	Value	Unit
Supply Voltage	V_{CC}	16	V
Lamp Current	I_{LAMP}	40	mA
Power Dissipation	P_D	400	mW
Operating Temperature	T_{OPR}	-20 ~ +70	$^\circ\text{C}$
Storage Temperature	T_{STG}	-40 ~ +125	$^\circ\text{C}$

ELECTRICAL CHARACTERISTICS

($T_a = 25^\circ\text{C}$, $V_{CC} = 6\text{V}$, $f = 1\text{KHz}$, $R_L = 3.3\text{K}\Omega$, unless otherwise specified)

Characteristic	Symbol	Test Conditions	Min	Typ	Max	Unit
Quiescent Circuit Current	I_{CCO}	$V_i = 0$		8.5	12	mA
Channel Separation	CS	$V_i = 100\text{mV}$, $L + R = 90\%$ $P = 10\%$, $f = 1\text{KHz}$	35	45		dB
Total Harmonic Distortion	Mono	THD 1	$V_i = 100\text{mV}$	0.2		%
	Stereo	THD 2	$L + R = 90\text{mV}$, $P = 10\text{mV}$	0.7		%
Output Voltage	V_o	$V_i = 100\text{mV}$, $f = 1\text{KHz}$	66	85	115	mV
Channel Balance	CB	$V_i = 100\text{mV}$, $f = 1\text{KHz}$		0.5	1.5	dB
Lamp on Level	$V_{L(ON)}$	$L + R = 90\%$, $P = 10\%$		65		mV
Lamp Hysteresis	HY			3.5	6.0	dB
Maximum Input Level	$V_{I(MAX)}$	THD=2%		450		mV
SCA Rejection Ratio	SCA_{REJ}	$L + R = 90\%$, $P = 10\%$		70		dB
Signal to Noise Ratio	S/N	$V_i = 100\text{mV}$, $f = 1\text{KHz}$		75		dB
Carrier Leakage	V_{LKG}	$V_i = 100\text{mV}$, $L + R = 90\%$ $P = 10\%$		32		dB
Capture Range	CR	$V_i = 100\text{mV}$, $L + R = 90\%$ $P = 10\%$		± 3		%
Input Impedance	Z_i		15	20		$\text{K}\Omega$

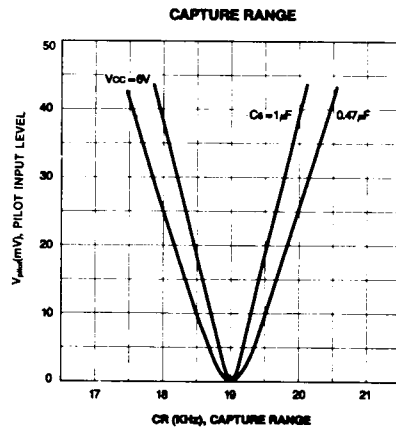
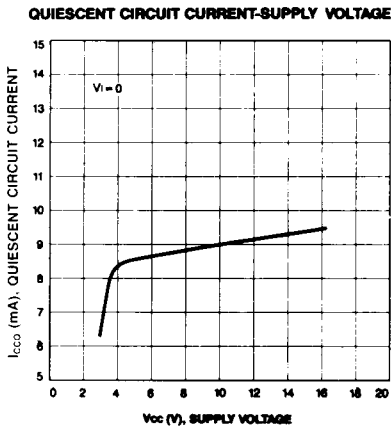
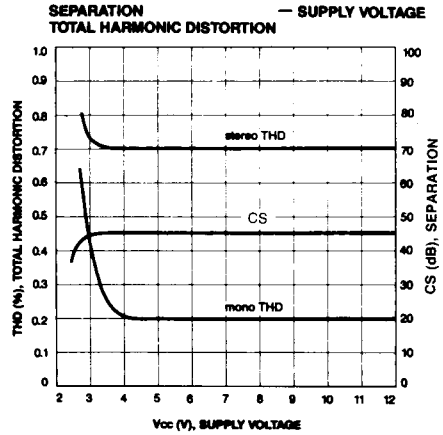
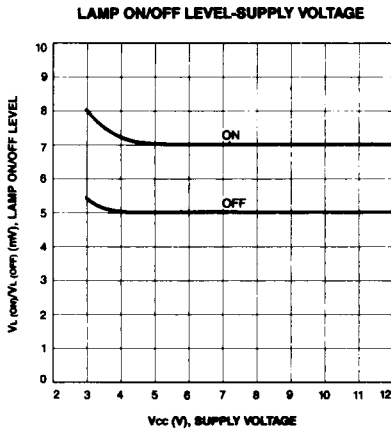
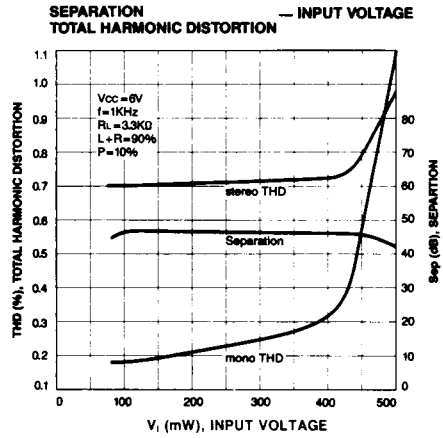
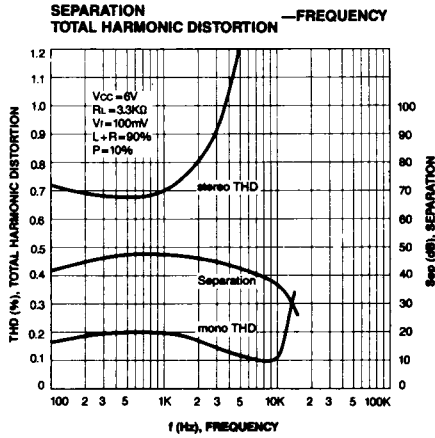

APPLICATION INFORMATION

External Components (Refer to Test Circuit)

- Input coupling capacitor (Pin 2)
The recommended value is $4.7\mu\text{F}$. If smaller values than $4.7\mu\text{F}$ are used, low frequency separation will worsen, and if larger values are used, the DC operating point will require time for stabilization.
- Demodulator output (Pin 4, 5)
These components provide R and L channel output load circuits. The recommended circuits are follows:

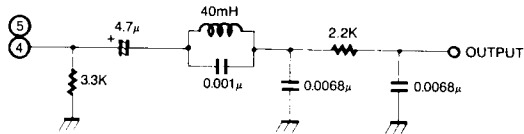

- Separation control (Pin 8)
This component is a variable resistor used to adjust the out signal separation.
- Low pass filter (Pins 10, 11)
This capacitor is used to filter the 19KHz signal detected by the phase comparator. The recommended value is $1\mu\text{F}$. If made too small, the lamp may light imprevoly when a large mono input signal or external noise is received, too large a capacitance value will take more time to switch between mono and stereo modes.
- Preamplifier output capacitor (Pins 3, 13)
This capacitor coupled preamplified with phase comparator. The recommended value is $0.047\mu\text{F}$.
- Phase compensation capacitor (Pin 3, GND)
This capacitor is prepared in order to compensate the phase advanced.
- Loop filter (Pins 14, 15)
This is the low pass filter for the PLL, which is determined the capture range. The recommended value as follows:
 $V_i \leq 250\text{mV}$ $C_{14-15} = 0.47\mu\text{F}$
 $V_i \geq 250\text{mV}$ $C_{14-15} = 1\mu\text{F}$
- Control of Pin 9
Function of Pin 9 is a change-over of stereo/mono and VCO stopping.

SCHEMATIC DIAGRAM of PIN 9 CONTROL

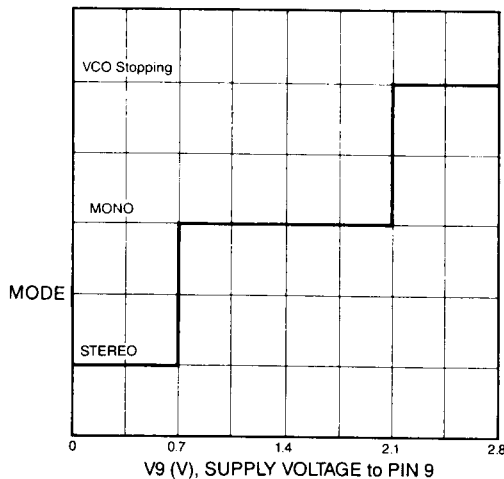

- VCO network (Pin 16)
Since the VCO has a negative temperature coefficient, the RC network compensates by using a polyester film capacitor and a resistor.