

### Features

- Fast Switching Speed
- Ultra-Small Surface Mount Package
- For General Purpose Switching Applications
- High Conductance

### Mechanical Data

- Case: SOD-323, Plastic
- Case material - UL Flammability Rating Classification 94V-0
- Moisture Sensitivity: Level 1 per J-STD-020A
- Polarity: Cathode Band
- Leads: Solderable per MIL-STD-202, Method 208
- Marking: T5
- Weight: 0.004 grams (approx.)

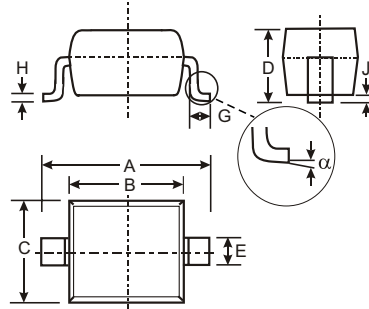

SOD-323		
Dim	Min	Max
A	2.30	2.70
B	1.60	1.80
C	1.20	1.40
D	1.05 Typical	
E	0.25	0.35
G	0.20	0.40
H	0.10	0.15
J	0.05 Typical	
$\alpha$	0°	8°
All Dimensions in mm		

### Maximum Ratings @ $T_A = 25^\circ\text{C}$ unless otherwise specified

Characteristic	Symbol	1N4448WS	Unit
Non-Repetitive Peak Reverse Voltage	$V_{RM}$	100	V
Peak Repetitive Reverse Voltage Working Peak Reverse Voltage DC Blocking Voltage	$V_{RRM}$ $V_{RWM}$ $V_R$	75	V
RMS Reverse Voltage	$V_{R(RMS)}$	53	V
Forward Continuous Current	$I_{FM}$	500	mA
Average Rectified Output Current	$I_O$	250	mA
Non-Repetitive Peak Forward Surge Current @ $t = 1.0\mu\text{s}$ @ $t = 1.0\text{s}$	$I_{FSM}$	4.0 2.0	A
Power Dissipation (Note 2)	$P_d$	200	mW
Thermal Resistance Junction to Ambient Air (Note 2)	$R_{\theta JA}$	625	$^\circ\text{C}/\text{W}$
Operating and Storage Temperature Range	$T_j, T_{STG}$	-65 to +150	$^\circ\text{C}$

### Electrical Characteristics @ $T_A = 25^\circ\text{C}$ unless otherwise specified

Characteristic	Symbol	Min	Max	Unit	Test Condition
Reverse Breakdown Voltage (Note 1)	$V_{(BR)R}$	75	—	V	$I_R = 2.5\mu\text{A}$
Forward Voltage (Note 1)	$V_{FM}$	0.62	0.72 0.855 1.0 1.25	V	$I_F = 5.0\text{mA}$ $I_F = 10\text{mA}$ $I_F = 100\text{mA}$ $I_F = 150\text{mA}$
Peak Reverse Current (Note 1)	$I_{RM}$	—	2.5 50 30 25	$\mu\text{A}$ $\mu\text{A}$ $\mu\text{A}$ nA	$V_R = 75\text{V}$ $V_R = 75\text{V}, T_j = 150^\circ\text{C}$ $V_R = 25\text{V}, T_j = 150^\circ\text{C}$ $V_R = 20\text{V}$
Total Capacitance	$C_T$	—	4.0	pF	$V_R = 0, f = 1.0\text{MHz}$
Reverse Recovery Time	$t_{rr}$	—	4.0	ns	$I_F = I_R = 10\text{mA}$ , $I_{rr} = 0.1 \times I_R, R_L = 100\Omega$

- Notes:
1. Short duration test pulse used to minimize self-heating.
  2. Part mounted on FR-4 PC board with minimum recommended pad layouts, which can be found on our website at <http://www.diodes.com/datasheets/ap02001.pdf>.

**Ordering Information**

(Note 3)

Device	Packaging	Shipping
1N4448WS-7	SOD-323	3000/Tape & Reel

Notes:

3. For Packaging Details, go to our website at <http://www.diodes.com/datasheets/ap02007.pdf>.

**Marking Information**

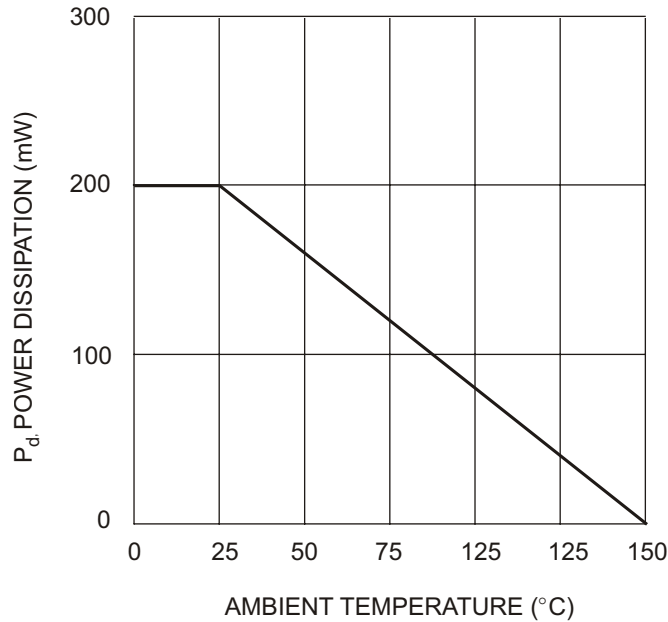
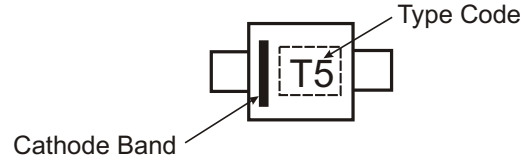

Fig. 1 Forward Current Derating Curve

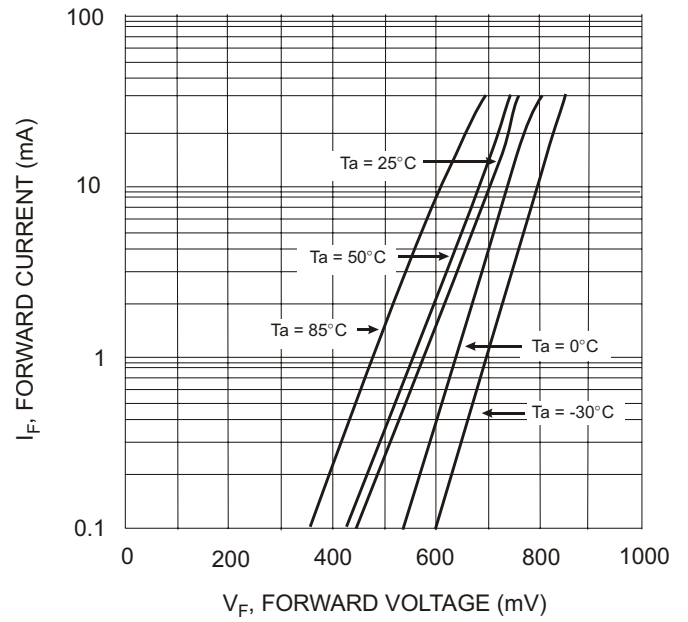

Fig. 2 Typical Forward Characteristics

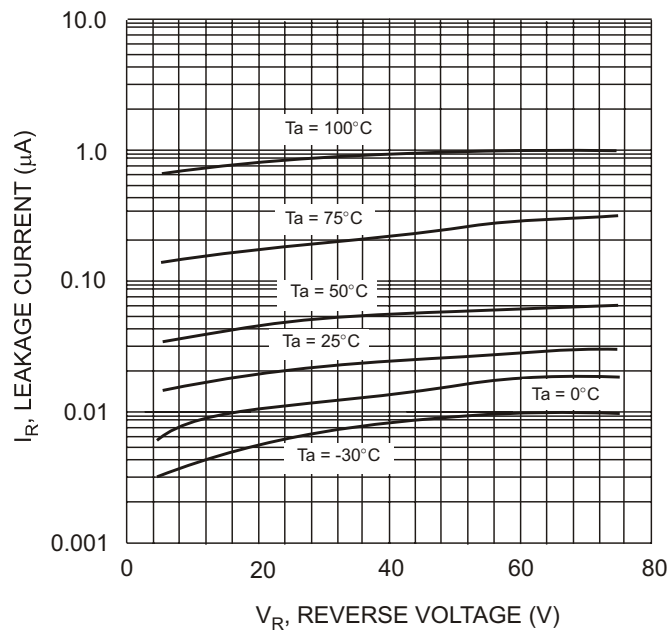

Fig. 3 Typical Reverse Characteristics

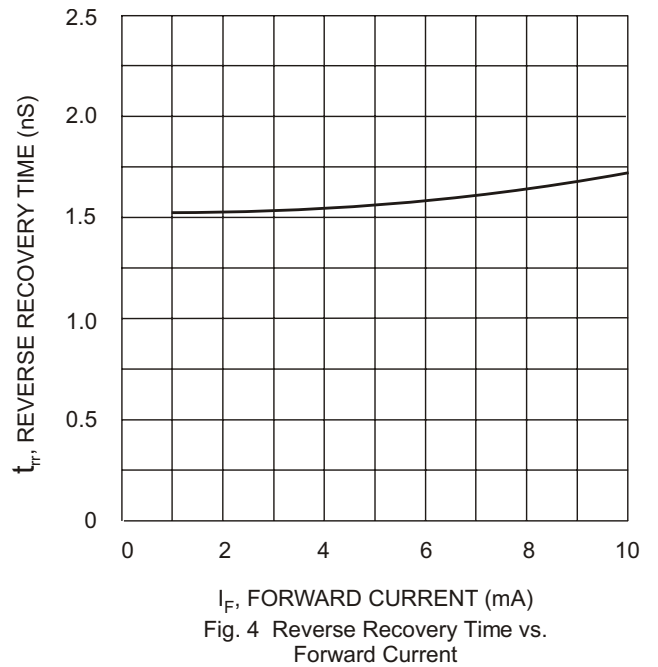
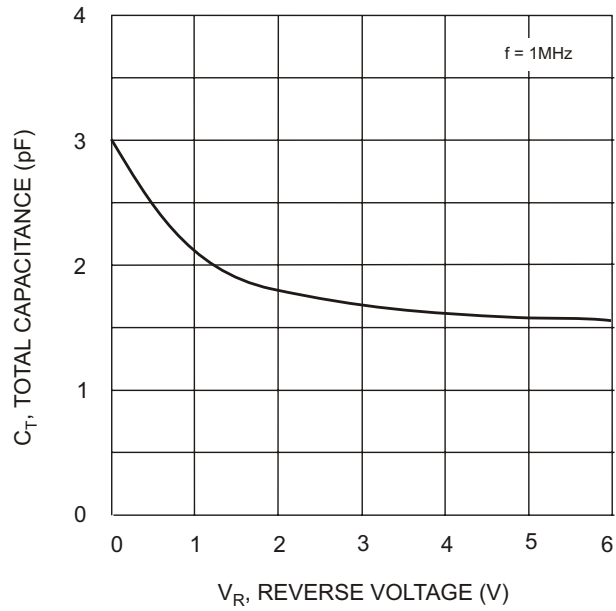

Fig. 4 Reverse Recovery Time vs. Forward Current



$V_R$ , REVERSE VOLTAGE (V)  
Fig. 5 Total Capacitance vs.  
Reverse Voltage