

Features

- Low Forward Voltage Drop
- Fast Switching
- Ultra-Small Surface Mount Package
- PN Junction Guard Ring for Transient and ESD Protection
- Available in Lead Free Version

Mechanical Data

- Case: SOT-323, Molded Plastic
- Case material - UL Flammability Rating 94V-0
- Moisture sensitivity: Level 1 per J-STD-020A
- Terminals: Solderable per MIL-STD-202, Method 208
- Also Available in Lead Free Plating (Matte Tin Finish). Please See Ordering Information, Note 4, on Page 3
- Polarity: See Diagrams Below
- Weight: 0.006 grams (approx.)
- Marking: See Diagrams Below & Page 3

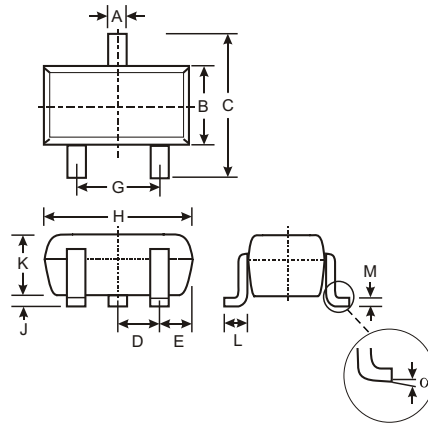

SOT-323		
Dim	Min	Max
A	0.25	0.40
B	1.15	1.35
C	2.00	2.20
D	0.65 Nominal	
E	0.30	0.40
G	1.20	1.40
H	1.80	2.20
J	0.0	0.10
K	0.90	1.00
L	0.25	0.40
M	0.10	0.18
α	0°	8°
All Dimensions in mm		

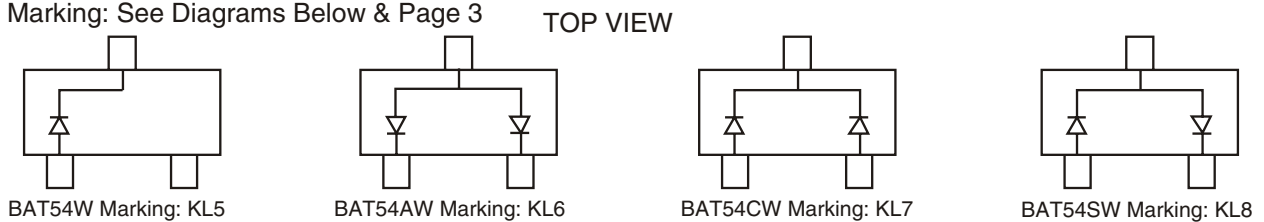

Maximum Ratings @ $T_A = 25^\circ\text{C}$ unless otherwise specified

Characteristic	Symbol	Value	Unit
Peak Repetitive Reverse Voltage Working Peak Reverse Voltage DC Blocking Voltage	V_{RRM} V_{RWM} V_R	30	V
Forward Continuous Current (Note 1)	I_F	200	mA
Repetitive Peak Forward Current (Note 1)	I_{FRM}	300	mA
Forward Surge Current (Note 1) @ $t < 1.0\text{s}$	I_{FSM}	600	mA
Power Dissipation (Note 1)	P_d	200	mW
Thermal Resistance, Junction to Ambient Air (Note 1)	$R_{\theta JA}$	625	$^\circ\text{C}/\text{W}$
Operating and Storage Temperature Range	T_j, T_{STG}	-65 to +125	$^\circ\text{C}$

Electrical Characteristics @ $T_A = 25^\circ\text{C}$ unless otherwise specified

Characteristic	Symbol	Min	Typ	Max	Unit	Test Condition
Reverse Breakdown Voltage (Note 2)	$V_{(BR)R}$	30	—	—	V	$I_R = 100\mu\text{A}$
Forward Voltage (Note 2)	V_F	—	—	240 320 400 500 1000	mV	$I_F = 0.1\text{mA}$ $I_F = 1\text{mA}$ $I_F = 10\text{mA}$ $I_F = 30\text{mA}$ $I_F = 100\text{mA}$
Reverse Leakage Current (Note 2)	I_R	—	—	2.0	μA	$V_R = 25\text{V}$
Total Capacitance	C_T	—	—	10	pF	$V_R = 1.0\text{V}, f = 1.0\text{MHz}$
Reverse Recovery Time	t_{rr}	—	—	5.0	ns	$I_F = 10\text{mA}$ through $I_R = 10\text{mA}$ to $I_R = 1.0\text{mA}, R_L = 100\Omega$

- Notes:
1. Mounted on FR4 PC Board with recommended pad layout which can be found on our website at <http://www.diodes.com/datasheets/ap02001.pdf>.
 2. Short duration test pulse used to minimize self-heating effect.

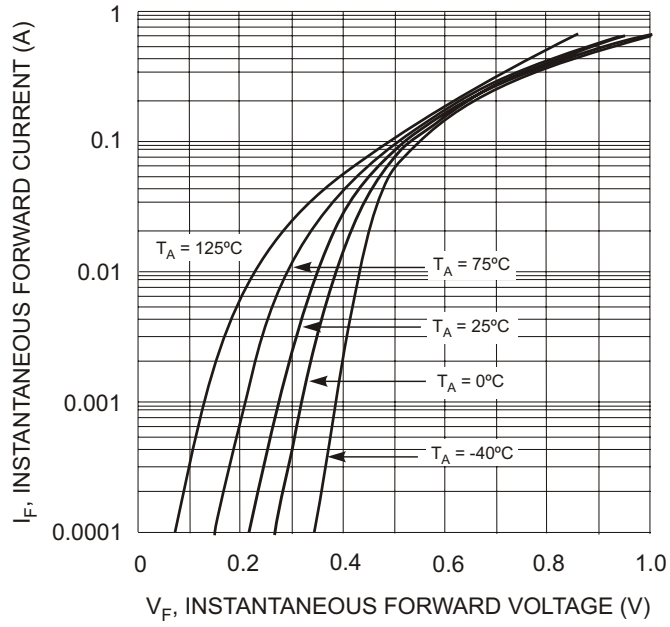

Fig. 1 Forward Characteristics

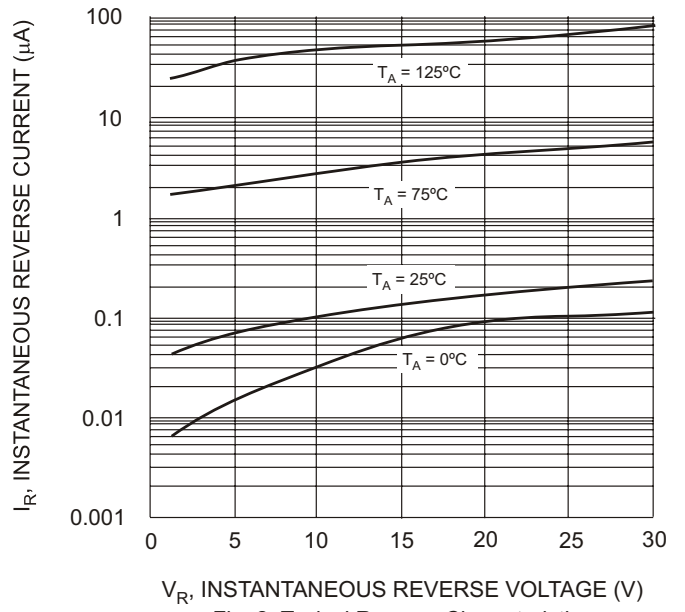

Fig. 2 Typical Reverse Characteristics

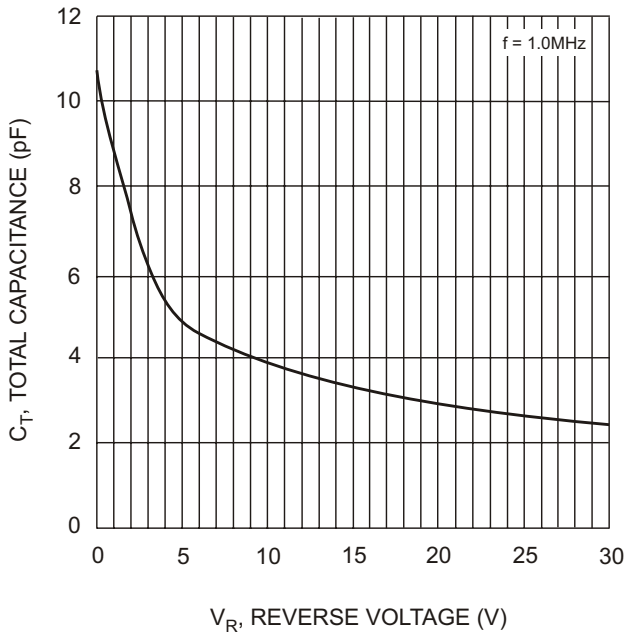

Fig. 3 Typical Capacitance vs. Reverse Voltage

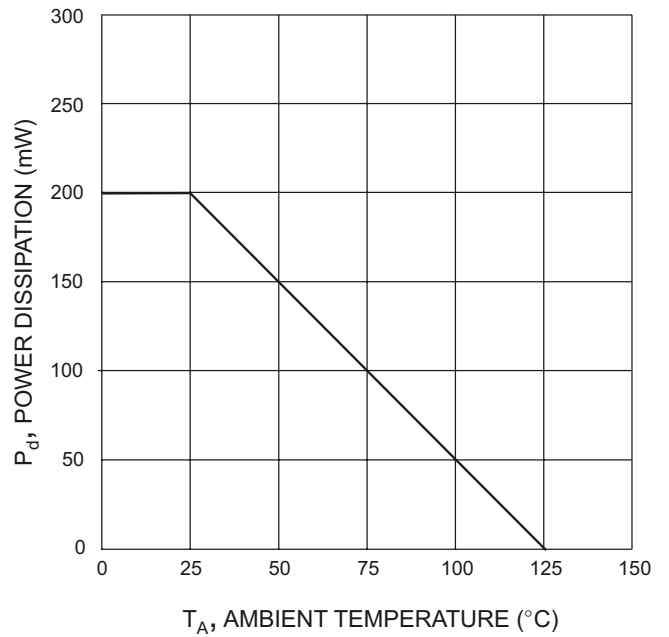

Fig. 4 Power Derating Curve

Ordering Information (Note 3 and 4)

Device	Packaging	Shipping
BAT54W-7	SOT-323	3000/Tape & Reel
BAT54AW-7	SOT-323	3000/Tape & Reel
BAT54CW-7	SOT-323	3000/Tape & Reel
BAT54SW-7	SOT-323	3000/Tape & Reel

- Notes: 3. For Packaging Details, go to our website at <http://www.diodes.com/datasheets/ap02007.pdf>.
 4. For lead free terminal plating part number, please add "-F" suffix to part number above. Example: BAT54W-7-F.

Marking Information

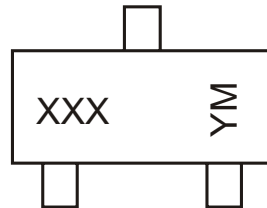

XXX = Product Type Marking Code (See Page 1 Diagrams)
 YM = Date Code Marking
 Y = Year ex: N = 2002
 M = Month ex: 9 = September

Date Code Key

Year	2000	2001	2002	2003	2004	2005	2006	2007	2008	2009
Code	L	M	N	P	R	S	T	U	V	W

Month	Jan	Feb	March	Apr	May	Jun	Jul	Aug	Sep	Oct	Nov	Dec
Code	1	2	3	4	5	6	7	8	9	O	N	D