

Features

- Epitaxial Planar Die Construction
- Complementary PNP Types Available (DDTA)
- Built-In Biasing Resistors, R1 = R2
- Also Available in Lead Free Version

Mechanical Data

- Case: SOT-523, Molded Plastic
- Case material - UL Flammability Rating 94V-0
- Moisture sensitivity: Level 1 per J-STD-020A
- Terminals: Solderable per MIL-STD-202, Method 208
- Also Available in Lead Free Plating (Matte Tin Finish). Please see Ordering Information, Note 3, on Page 2
- Terminal Connections: See Diagram
- Marking: Date Code and Marking Code (See Diagrams & Page 2)
- Weight: 0.002 grams (approx.)
- Ordering Information (See Page 2)

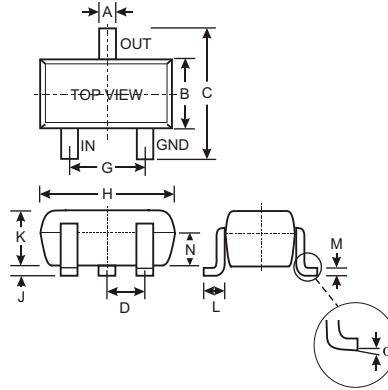

SOT-523			
Dim	Min	Max	Typ
A	0.15	0.30	0.22
B	0.75	0.85	0.80
C	1.45	1.75	1.60
D	—	—	0.50
G	0.90	1.10	1.00
H	1.50	1.70	1.60
J	0.00	0.10	0.05
K	0.60	0.80	0.75
L	0.10	0.30	0.22
M	0.10	0.20	0.12
N	0.45	0.65	0.50
α	0°	8°	—
All Dimensions in mm			

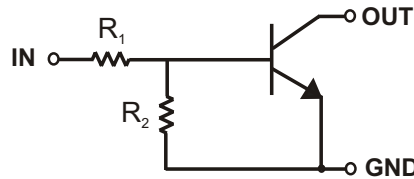

SCHEMATIC DIAGRAM

P/N	R1, R2 (NOM)	MARKING
DDTC123EE	2.2K Ω	N04
DDTC143EE	4.7K Ω	N08
DDTC114EE	10K Ω	N13
DDTC124EE	22K Ω	N17
DDTC144EE	47K Ω	N20
DDTC115EE	100K Ω	N24

Maximum Ratings @ T_A = 25°C unless otherwise specified

Characteristic	Symbol	Value	Unit
Supply Voltage, (3) to (1)	V _{CC}	50	V
Input Voltage, (2) to (1)	V _{IN}	-10 to +12 -10 to +30 -10 to +40 -10 to +40 -10 to +40 -10 to +40	V
Output Current	I _O	100 100 50 30 100 20	mA
Power Dissipation	P _d	150	mW
Thermal Resistance, Junction to Ambient Air (Note 1)	R _{θJA}	833	°C/W
Operating and Storage and Temperature Range	T _j , T _{STG}	-55 to +150	°C

Note: 1. Mounted on FR4 PC Board with recommended pad layout at <http://www.diodes.com/datasheets/ap02001.pdf>.

Electrical Characteristics @ T_A = 25°C unless otherwise specified

Characteristic	Symbol	Min	Typ	Max	Unit	Test Condition
Input Voltage	V _{I(off)}	0.5	1.1	—	V	V _{CC} = 5V, I _O = 100μA
	V _{I(on)}	—	1.9	3		V _O = 0.3V, I _O = 20mA, DDTC123EE V _O = 0.3V, I _O = 20mA, DDTC143EE V _O = 0.3V, I _O = 10mA, DDTC114EE V _O = 0.3V, I _O = 5mA, DDTC124EE V _O = 0.3V, I _O = 2mA, DDTC144EE V _O = 0.3V, I _O = 1mA, DDTC115EE
Output Voltage	V _{O(on)}	—	0.1	0.3	V	I _O /I _I = 10mA/0.5mA, DDTC123EE I _O /I _I = 10mA/0.5mA, DDTC143EE I _O /I _I = 10mA/0.5mA, DDTC114EE I _O /I _I = 10mA/0.5mA, DDTC124EE I _O /I _I = 10mA/0.5mA, DDTC144EE I _O /I _I = 5mA/0.25mA, DDTC115EE
Input Current	I _I	—	—	3.8 1.8 0.88 0.36 0.18 0.15	mA	V _I = 5V
Output Current	I _{O(off)}	—	—	0.5	μA	V _{CC} = 50V, V _I = 0V
DC Current Gain	G _I	20 20 30 56 68 82	—	—	—	V _O = 5V, I _O = 20mA V _O = 5V, I _O = 10mA V _O = 5V, I _O = 5mA V _O = 5V, I _O = 5mA V _O = 5V, I _O = 5mA V _O = 5V, I _O = 5mA
Input Resistor (R ₁) Tolerance	DR ₁	-30	—	+30	%	—
Resistance Ratio	R ₂ /R ₁	0.8	1	1.2	—	—
Gain-Bandwidth Product*	f _T	—	250	—	MHz	V _{CE} = 10V, I _E = 5mA, f = 100MHz

* Transistor - For Reference Only

Ordering Information (Note 2)

Device	Packaging	Shipping
DDTC123EE-7	SOT-523	3000/Tape & Reel
DDTC143EE-7	SOT-523	3000/Tape & Reel
DDTC114EE-7	SOT-523	3000/Tape & Reel
DDTC124EE-7	SOT-523	3000/Tape & Reel
DDTC144EE-7	SOT-523	3000/Tape & Reel
DDTC115EE-7	SOT-523	3000/Tape & Reel

- Notes: 2. For Packaging Details, go to our website at <http://www.diodes.com/datasheets/ap02007.pdf>.
3. For Lead Free version (with Lead Free terminal finish) part number, please add "-F" suffix to part number above.
Example: DDTC115EE-7-F.

Marking Information

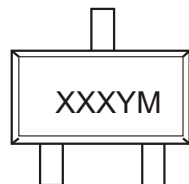

XXX = Product Type Marking Code (See Page 1)

YM = Date Code Marking

Y = Year ex: P = 2003

M = Month ex: 9 = September

Date Code Key

Year	2002	2003	2004	2005	2006	2007	2008	2009
Code	N	P	R	S	T	U	V	W

Month	Jan	Feb	March	Apr	May	Jun	Jul	Aug	Sep	Oct	Nov	Dec
Code	1	2	3	4	5	6	7	8	9	O	N	D

TYPICAL CURVES - DDTC143EE

NEW PRODUCT

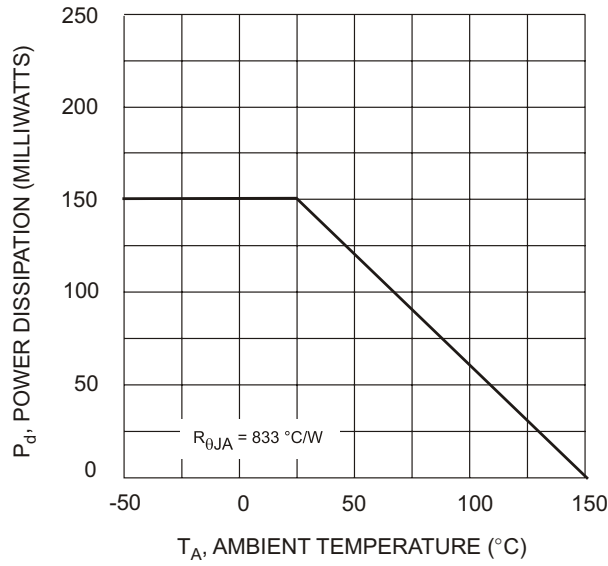

Fig. 1 Derating Curve

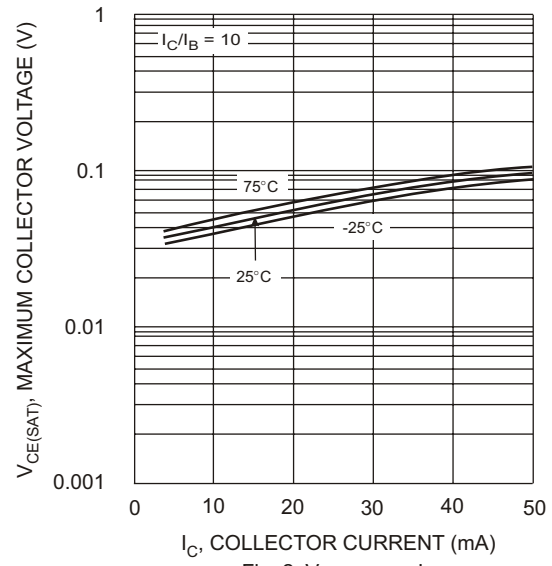

Fig. 2 $V_{CE(SAT)}$ vs. I_C

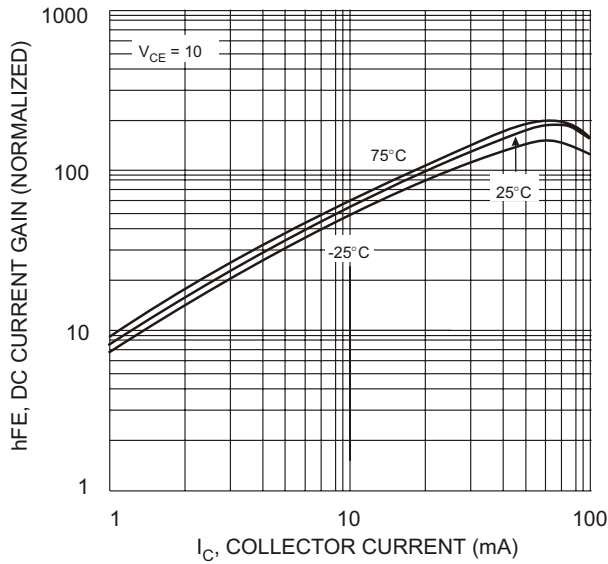

Fig. 3 DC CURRENT GAIN

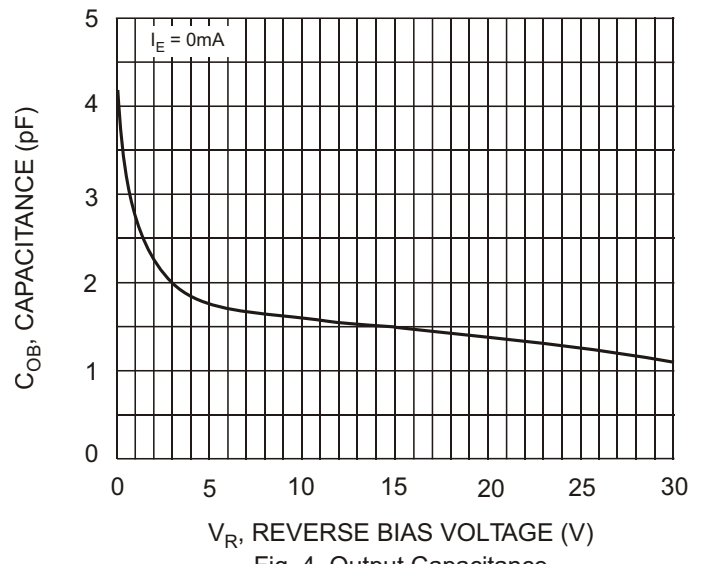

Fig. 4 Output Capacitance

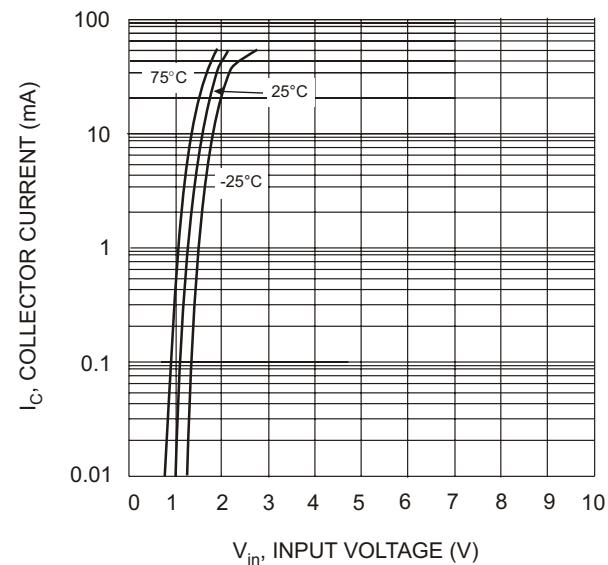

Fig. 5 Collector Current Vs. Input Voltage

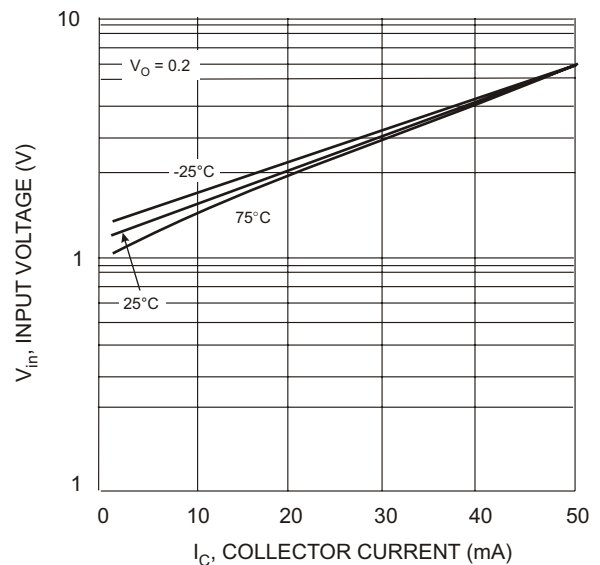

Fig. 6 Input Voltage vs. Collector Current