

### Features

- Fast Switching Speed
- Ultra-Small Surface Mount Package
- For General Purpose Switching Applications
- High Conductance

### Mechanical Data

- Case: SOT-353 or SOT-363, Molded Plastic
- Case Material - UL Flammability Rating Classification 94V-0
- Moisture sensitivity: Level 1 per J-STD-020A
- Terminals: Solderable per MIL-STD-202, Method 208
- Orientation: See Diagrams Below
- Marking: See Diagrams Below & Page 3
- Weight: 0.006 grams (approx.)

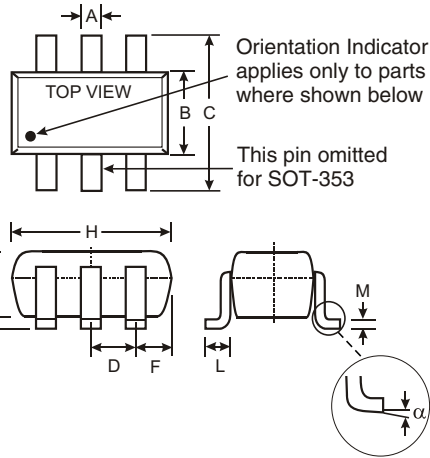

SOT-363/SOT-353		
Dim	Min	Max
A	0.10	0.30
B	1.15	1.35
C	2.00	2.20
D	0.65 Nominal	
F	0.30	0.40
H	1.80	2.20
J	—	0.10
K	0.90	1.00
L	0.25	0.40
M	0.10	0.25
α	0°	8°

All Dimensions in mm

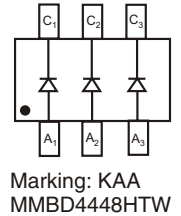
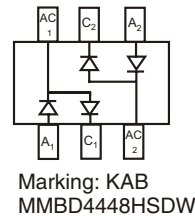
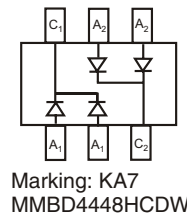
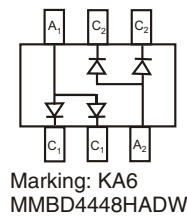
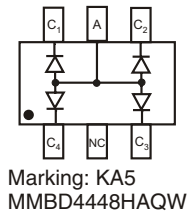
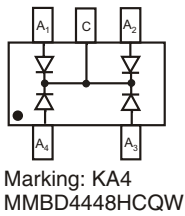

### Maximum Ratings @ T<sub>A</sub> = 25°C unless otherwise specified

Characteristic	Symbol	Value	Unit
Non-Repetitive Peak Reverse Voltage	V <sub>RM</sub>	100	V
Peak Repetitive Reverse Voltage Working Peak Reverse Voltage DC Blocking Voltage	V <sub>R(RM)</sub> V <sub>R(WM)</sub> V <sub>R</sub>	80	V
RMS Reverse Voltage	V <sub>R(RMS)</sub>	57	V
Forward Continuous Current (Note 1)	I <sub>FM</sub>	500	mA
Average Rectified Output Current (Note 1)	I <sub>O</sub>	250	mA
Non-Repetitive Peak Forward Surge Current @ t = 1.0μs @ t = 1.0s	I <sub>FSM</sub>	4.0 2.0	A
Power Dissipation (Note 1)	P <sub>d</sub>	200	mW
Thermal Resistant Junction to Ambient Air (Note 1)	R <sub>θJA</sub>	625	°C/W
Operating and Storage Temperature Range	T <sub>J</sub> , T <sub>STG</sub>	-65 to +150	°C

Notes: 1. Device mounted on FR-4 PCB, 1 inch x 0.85 inch x 0.062 inch; pad layout as shown on Diodes Inc. suggested pad layout document AP02001, which can be found on our website at <http://www.diodes.com/datasheets/ap02001.pdf>.

**Electrical Characteristics** @  $T_A = 25^\circ\text{C}$  unless otherwise specified

Characteristic	Symbol	Min	Max	Unit	Test Condition
Reverse Breakdown Voltage (Note 2)	$V_{(BR)R}$	80	—	V	$I_R = 100\mu\text{A}$
Forward Voltage (Note 2)	$V_F$	0.62	0.72 0.855 1.0 1.25	V	$I_F = 5.0\text{mA}$ $I_F = 10\text{mA}$ $I_F = 100\text{mA}$ $I_F = 150\text{mA}$
Reverse Current (Note 2)	$I_R$	—	100 50 30 25	nA $\mu\text{A}$ $\mu\text{A}$ nA	$V_R = 70\text{V}$ $V_R = 75\text{V}, T_j = 150^\circ\text{C}$ $V_R = 25\text{V}, T_j = 150^\circ\text{C}$ $V_R = 20\text{V}$
Total Capacitance	$C_T$	—	3.5	pF	$V_R = 6\text{V}, f = 1.0\text{MHz}$
Reverse Recovery Time	$t_{rr}$	—	4.0	ns	$V_R = 6\text{V}, I_F = 5\text{mA}$

Notes: 2. Short duration test pulse used to minimize self-heating effect.

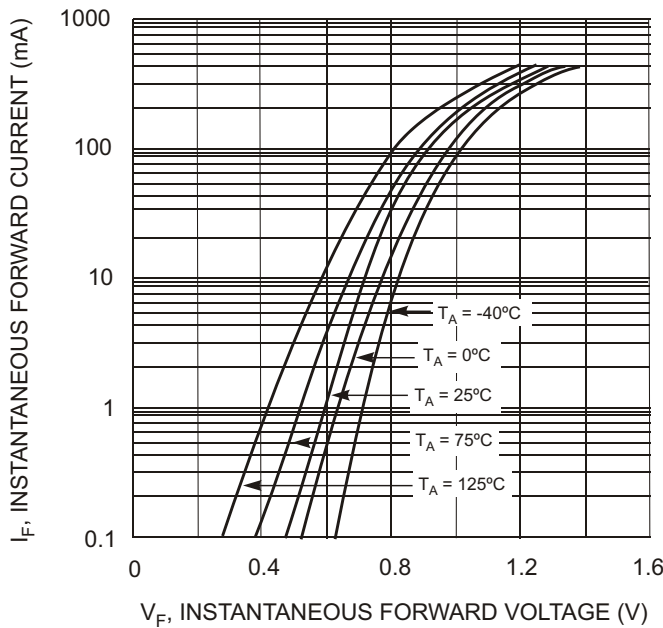

Fig. 1 Typical Forward Characteristics

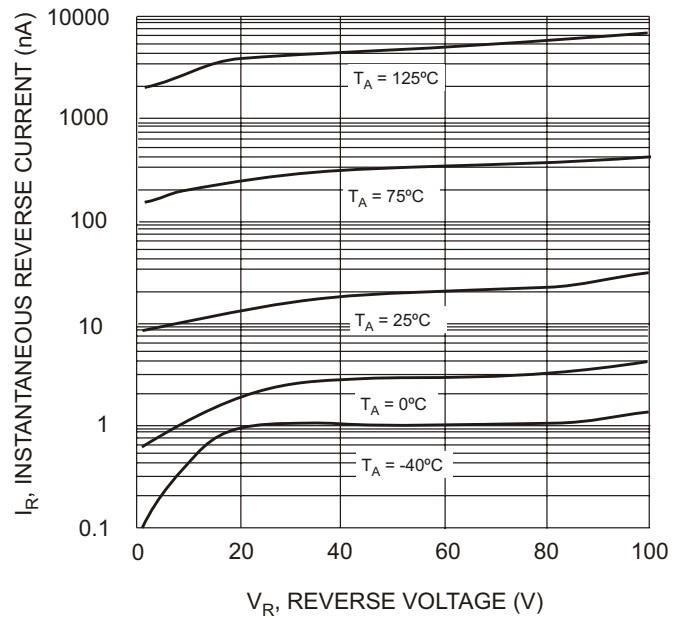

Fig. 2 Typical Reverse Characteristics

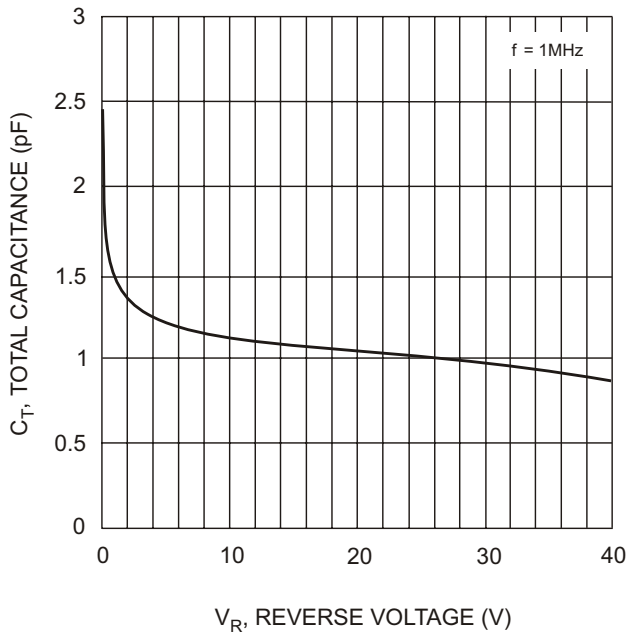

Fig. 3 Typical Capacitance vs. Reverse Voltage

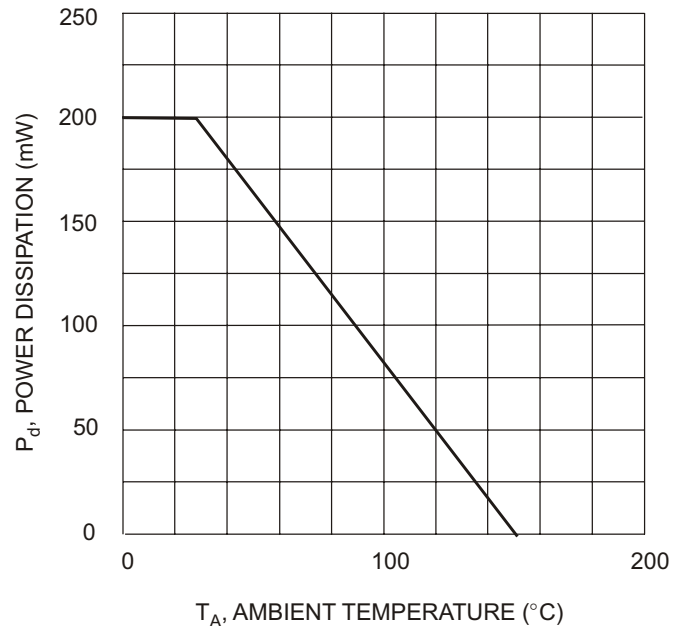

Fig. 4 Power Derating Curve, Total Package

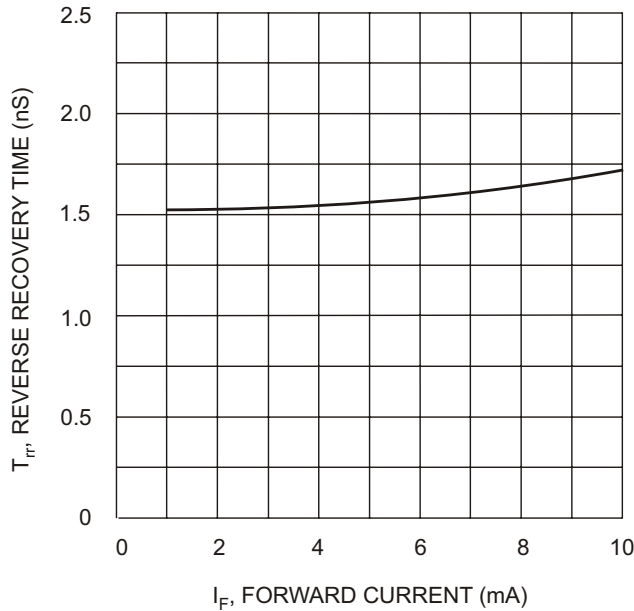

Fig. 5 Reverse Recovery Time vs. Forward Current

**Ordering Information** (Note 3)

Device	Packaging	Shipping
MMBD4448HADW-7	SOT-363	3000/Tape & Reel
MMBD4448HAQW-7	SOT-363	3000/Tape & Reel
MMBD4448HCDW-7	SOT-363	3000/Tape & Reel
MMBD4448HCQW-7	SOT-353	3000/Tape & Reel
MMBD4448HSDW-7	SOT-363	3000/Tape & Reel
MMBD4448HTW-7	SOT-363	3000/Tape & Reel

Notes: 3. For Packaging Details, go to our website at <http://www.diodes.com/datasheets/ap02007.pdf>.

**Marking Information**

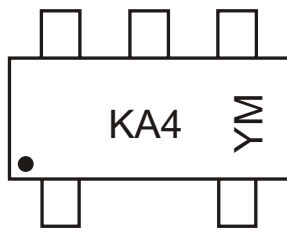

SOT-353

KA4 = Product Type Marking Code, KA4 = MMBD4448HCQW  
YM = Date Code Marking  
Y = Year ex: N = 2002  
M = Month ex: 9 = September

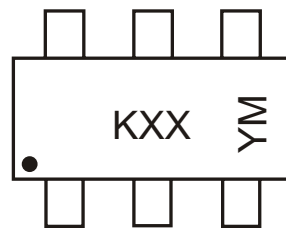

SOT-363

KXX = Product Type Marking Code, ex. KA5 = MMBD4448HAQW  
KAA = MMBD4448HTW  
YM = Date Code Marking  
Y = Year ex: N = 2002  
M = Month ex: 9 = September

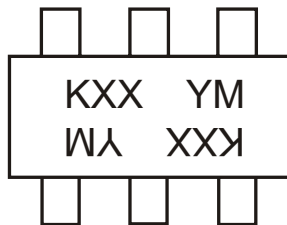

SOT-363

KXX = Product Type Marking Code, ex. KA6 = MMBD4448HADW  
KA7 = MMBD4448HCDW  
KAB = MMBD4448HSDW  
YM = Date Code Marking  
Y = Year ex: N = 2002  
M = Month ex: 9 = September

Date Code Key

Year	2000	2001	2002	2003	2004	2005	2006	2007	2008	2009
Code	L	M	N	P	R	S	T	U	V	W

Month	Jan	Feb	March	Apr	May	Jun	Jul	Aug	Sep	Oct	Nov	Dec
Code	1	2	3	4	5	6	7	8	9	O	N	D