

### Features

- Epitaxial Planar Die Construction
- Complementary NPN Type Available (MMBT2222AT)
- Ultra-Small Surface Mount Package
- Also Available in Lead Free Version

### Mechanical Data

- Case: SOT-523, Molded Plastic
- Case material - UL Flammability Rating 94V-0
- Moisture sensitivity: Level 1 per J-STD-020A
- Terminals: Solderable per MIL-STD-202, Method 208
- Also Available in Lead Free Plating (Matte Tin Finish). Please See Ordering Information, Note 4, on Page 2
- Terminal Connections: See Diagram
- Marking (See Page 2): 2F
- Ordering & Date Code Information, See Page 2

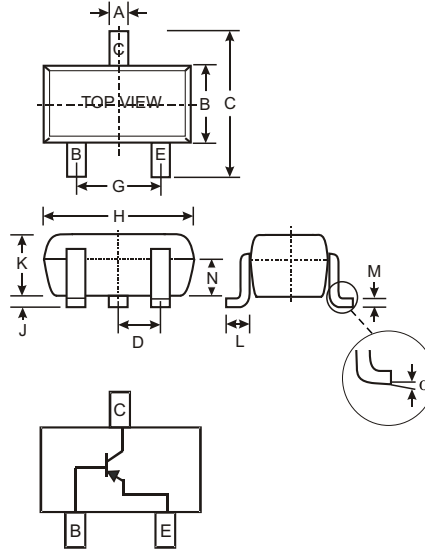

SOT-523			
Dim	Min	Max	Typ
A	0.15	0.30	0.22
B	0.75	0.85	0.80
C	1.45	1.75	1.60
D	—	—	0.50
G	0.90	1.10	1.00
H	1.50	1.70	1.60
J	0.00	0.10	0.05
K	0.60	0.80	0.75
L	0.10	0.30	0.22
M	0.10	0.20	0.12
N	0.45	0.65	0.50
$\alpha$	0°	8°	—
All Dimensions in mm			

### Maximum Ratings @ $T_A = 25^\circ\text{C}$ unless otherwise specified

Characteristic	Symbol	Value	Unit
Collector-Base Voltage	$V_{CBO}$	-60	V
Collector-Emitter Voltage	$V_{CEO}$	-60	V
Emitter-Base Voltage	$V_{EBO}$	-5.0	V
Collector Current - Continuous	$I_C$	-600	mA
Power Dissipation (Note 1)	$P_d$	150	mW
Thermal Resistance, Junction to Ambient (Note 1)	$R_{\theta JA}$	833	$^\circ\text{C}/\text{W}$
Operating and Storage and Temperature Range	$T_j, T_{STG}$	-55 to +150	$^\circ\text{C}$

Notes: 1. Device mounted on FR-4 PCB, 1 inch x 0.85 inch x 0.062 inch; pad layout as shown on Diodes Inc. suggested pad layout document AP02001, which can be found on our website at <http://www.diodes.com/datasheets/ap02001.pdf>.

**Electrical Characteristics** @  $T_A = 25^\circ\text{C}$  unless otherwise specified

Characteristic	Symbol	Min	Max	Unit	Test Condition
<b>OFF CHARACTERISTICS (Note 2)</b>					
Collector-Base Breakdown Voltage	$V_{(BR)CBO}$	-60	—	V	$I_C = -10\mu\text{A}, I_E = 0$
Collector-Emitter Breakdown Voltage	$V_{(BR)CEO}$	-60	—	V	$I_C = -10\text{mA}, I_B = 0$
Emitter-Base Breakdown Voltage	$V_{(BR)EBO}$	-5.0	—	V	$I_E = -10\mu\text{A}, I_C = 0$
Collector Cutoff Current	$I_{CBO}$	—	-10	nA $\mu\text{A}$	$V_{CB} = -50\text{V}, I_E = 0$ $V_{CB} = -50\text{V}, I_E = 0, T_A = 125^\circ\text{C}$
Collector Cutoff Current	$I_{CEX}$	—	-50	nA	$V_{CE} = -30\text{V}, V_{EB(OFF)} = -0.5\text{V}$
Base Cutoff Current	$I_{BL}$	—	-50	nA	$V_{CE} = -30\text{V}, V_{EB(OFF)} = -0.5\text{V}$
<b>ON CHARACTERISTICS (Note 2)</b>					
DC Current Gain	$h_{FE}$	75 100 100 100 50	— — — 300 —	—	$I_C = -100\mu\text{A}, V_{CE} = -10\text{V}$ $I_C = -1.0\text{mA}, V_{CE} = -10\text{V}$ $I_C = -10\text{mA}, V_{CE} = -10\text{V}$ $I_C = -150\text{mA}, V_{CE} = -10\text{V}$ $I_C = -500\text{mA}, V_{CE} = -10\text{V}$
Collector-Emitter Saturation Voltage	$V_{CE(SAT)}$	—	-0.4 -1.6	V	$I_C = -150\text{mA}, I_B = -15\text{mA}$ $I_C = -500\text{mA}, I_B = -50\text{mA}$
Base-Emitter Saturation Voltage	$V_{BE(SAT)}$	—	-1.3 -2.6	V	$I_C = 150\text{mA}, I_B = 15\text{mA}$ $I_C = 500\text{mA}, I_B = 50\text{mA}$
<b>SMALL SIGNAL CHARACTERISTICS</b>					
Output Capacitance	$C_{obo}$	—	8.0	pF	$V_{CB} = -10\text{V}, f = 1.0\text{MHz}, I_E = 0$
Input Capacitance	$C_{ibo}$	—	30	pF	$V_{EB} = -2.0\text{V}, f = 1.0\text{MHz}, I_C = 0$
Current Gain-Bandwidth Product	$f_T$	200	—	MHz	$V_{CE} = -20\text{V}, I_C = -50\text{mA}, f = 100\text{MHz}$
<b>SWITCHING CHARACTERISTICS</b>					
Turn-On Time	$t_{off}$	—	45	ns	
Delay Time	$t_d$	—	10	ns	$V_{CC} = -30\text{V}, I_C = -150\text{mA}, I_{B1} = -15\text{mA}$
Rise Time	$t_r$	—	40	ns	
Turn-Off Time	$t_{off}$	—	100	ns	
Storage Time	$t_s$	—	80	ns	$V_{CC} = -6.0\text{V}, I_C = -150\text{mA}, I_{B1} = I_{B2} = -15\text{mA}$
Fall Time	$t_f$	—	30	ns	

**Ordering Information** (Note 3 & 4)

Device	Packaging	Shipping
MMBT2907AT-7	SOT-523	3000/Tape & Reel

- Notes:
- Short duration test pulse used to minimize self-heating effect.
  - For Packaging Details, go to our website at <http://www.diodes.com/datasheets/ap02007.pdf>.
  - For lead free terminal plating part number, please add "-F" suffix to part number above. Example: MMBT2907AT-7-F.

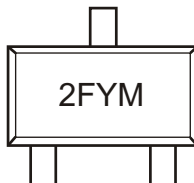
**Marking Information**

2F = Product Type Marking Code  
 YM = Date Code Marking  
 Y = Year (ex: N = 2002)  
 M = Month (ex: 9 = September)

**Date Code Key**

Year	1998	1999	2000	2001	2002	2003	2004
Code	J	K	L	M	N	P	R

Month	Jan	Feb	March	Apr	May	Jun	Jul	Aug	Sep	Oct	Nov	Dec
Code	1	2	3	4	5	6	7	8	9	O	N	D

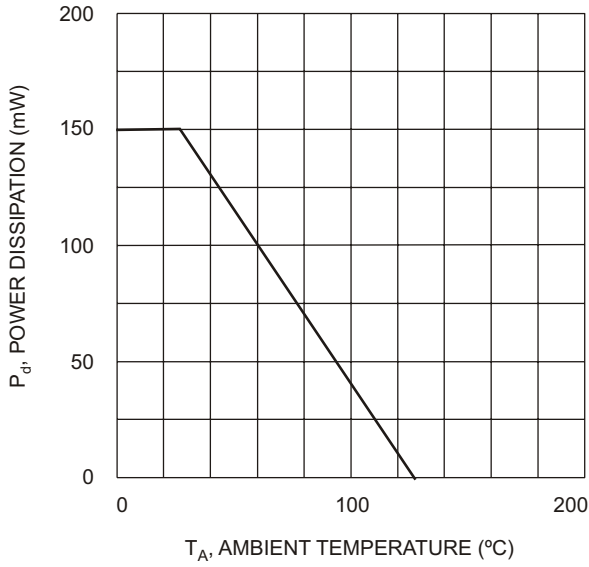

$T_A$ , AMBIENT TEMPERATURE (°C)  
Fig. 1 Power Derating Curve, Total Package

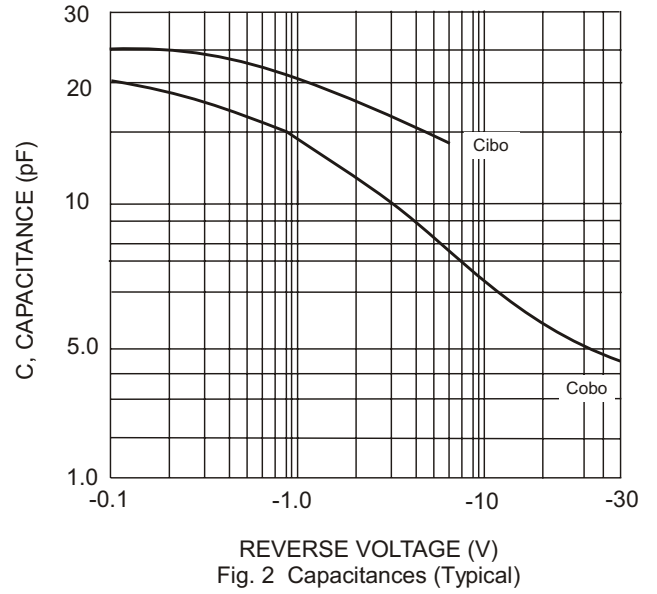

REVERSE VOLTAGE (V)  
Fig. 2 Capacitances (Typical)

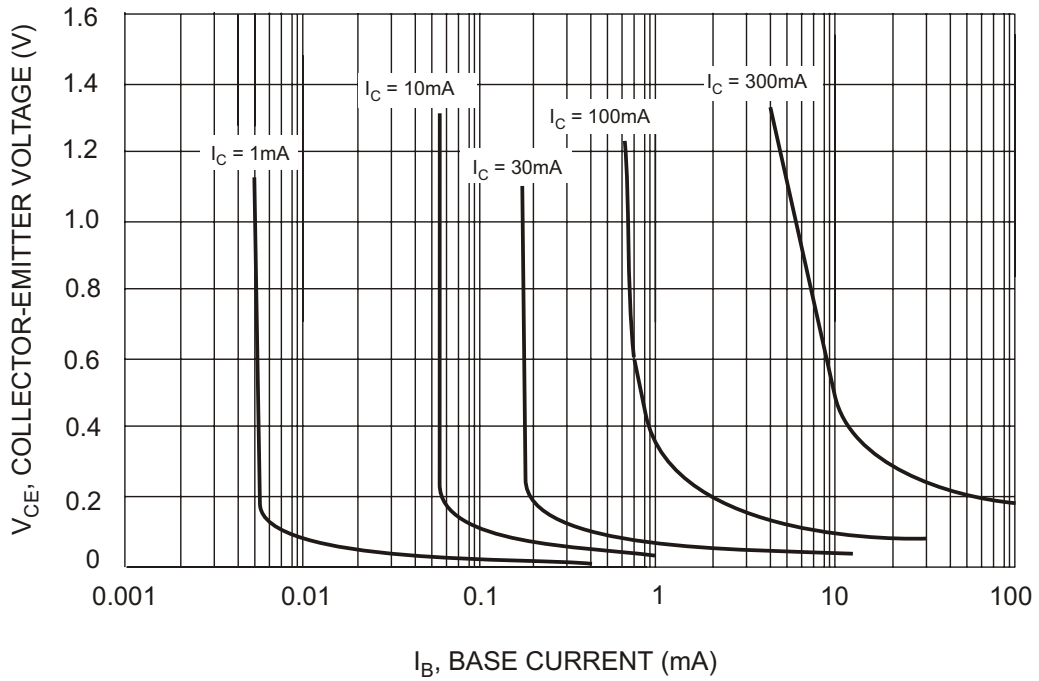

$I_B$ , BASE CURRENT (mA)  
Fig. 3 Typical Collector Saturation Region

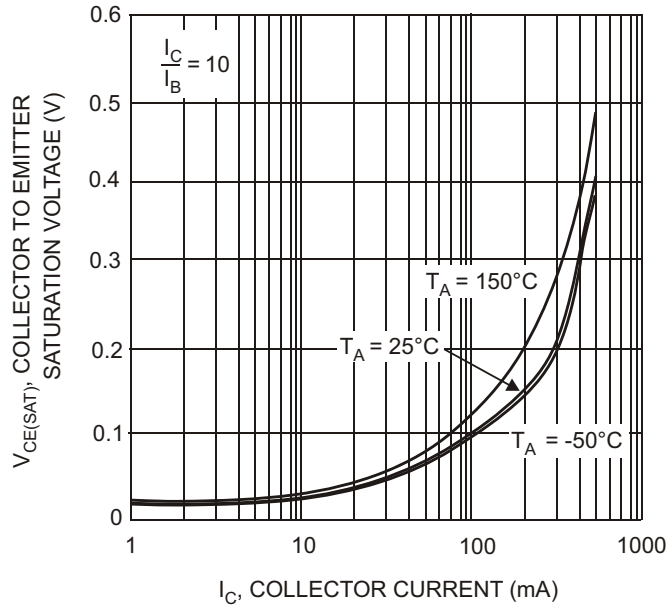

Fig. 4, Collector Emitter Saturation Voltage vs. Collector Current

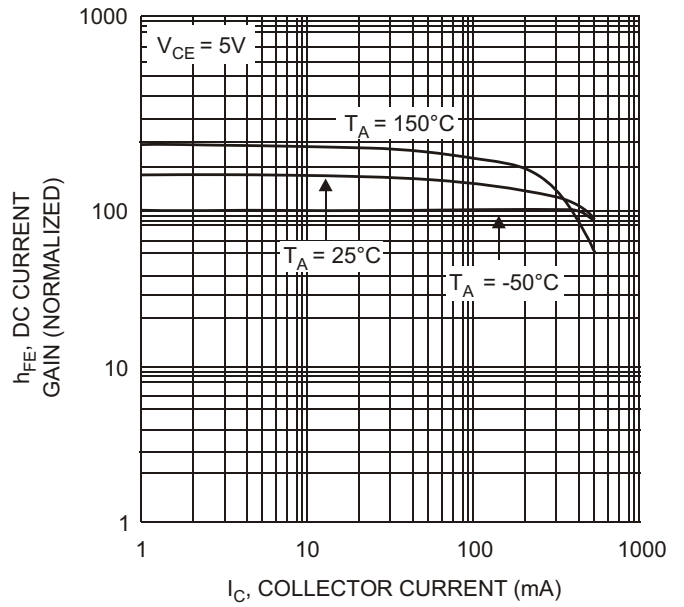

Fig. 5, DC Current Gain vs. Collector Current

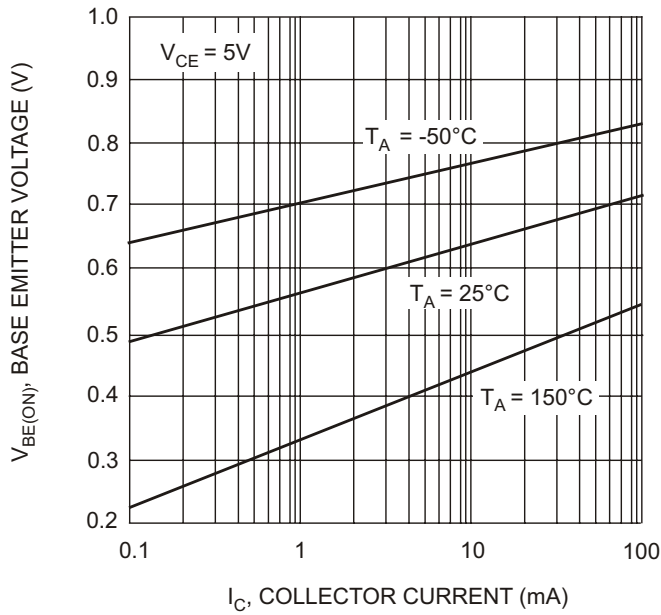

Fig. 6, Base Emitter Voltage vs. Collector Current

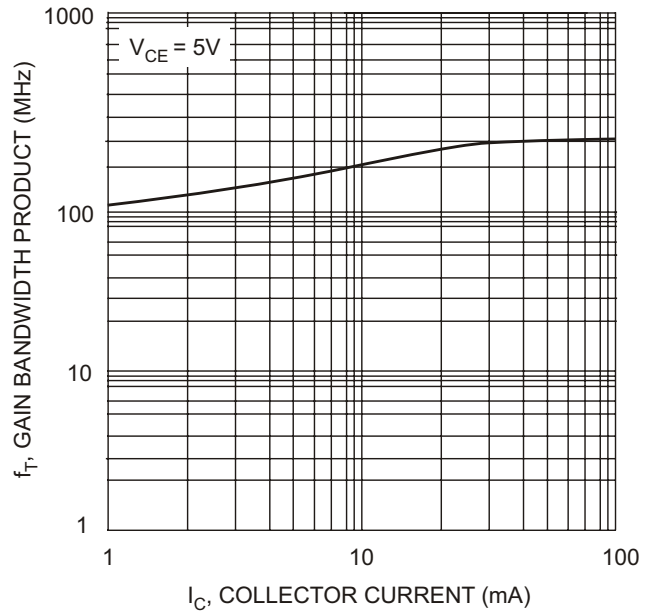

Fig. 7, Gain Bandwidth Product vs. Collector Current