

Features

- Epitaxial Planar Die Construction
- Complementary PNP Type Available (MMSTA55/MMSTA56)
- Ideal for Medium Power Amplification and Switching
- Ultra-Small Surface Mount Package
- Also Available in Lead Free Version

Mechanical Data

- Case: SOT-323, Molded Plastic
- Case Material - UL Flammability Rating 94V-0
- Moisture sensitivity: Level 1 per J-STD-020A
- Terminals: Solderable per MIL-STD-202, Method 208
- Also Available in Lead Free Plating (Matte Tin Finish). Please see Ordering Information, Note 4, on Page 2
- Terminal Connections: See Diagram
- MMSTA05 Marking K1H, K1G (See Page 2)
- MMSTA06 Marking K1G (See Page 2)
- Order & Date Code Information: See Page 2
- Weight: 0.006 grams (approx.)

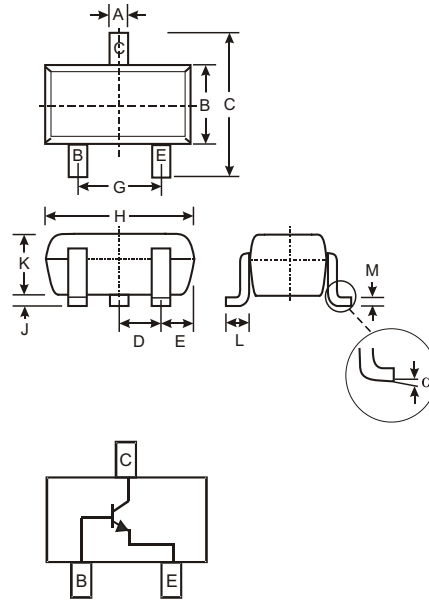

SOT-323		
Dim	Min	Max
A	0.25	0.40
B	1.15	1.35
C	2.00	2.20
D	0.65 Nominal	
E	0.30	0.40
G	1.20	1.40
H	1.80	2.20
J	0.0	0.10
K	0.90	1.00
L	0.25	0.40
M	0.10	0.18
α	0°	8°
All Dimensions in mm		

Maximum Ratings @ $T_A = 25^\circ\text{C}$ unless otherwise specified

Characteristic	Symbol	MMSTA05	MMSTA06	Unit
Collector-Base Voltage	V_{CBO}	60	80	V
Collector-Emitter Voltage	V_{CEO}	60	80	V
Emitter-Base Voltage	V_{EBO}	4.0		V
Collector Current - Continuous (Note 1)	I_C	500		mA
Power Dissipation (Note 1)	P_d	200		mW
Thermal Resistance, Junction to Ambient (Note 1)	$R_{\theta JA}$	625		$^\circ\text{C/W}$
Operating and Storage and Temperature Range	T_j, T_{STG}	-55 to +150		$^\circ\text{C}$

Note: 1. Device mounted on FR-4 PCB, 1 inch x 0.85 inch x 0.062 inch; pad layout as shown on Diodes Inc. suggested pad layout document AP02001, which can be found on our website at <http://www.diodes.com/datasheets/ap02001.pdf>.

Electrical Characteristics @ T_A = 25°C unless otherwise specified

Characteristic	Symbol	Min	Max	Unit	Test Condition	
OFF CHARACTERISTICS (Note 2)						
Collector-Base Breakdown Voltage	MMSTA05 MMSTA06	V _{(BR)CBO}	60 80	—	V	I _C = 100μA, I _E = 0
Collector-Emitter Breakdown Voltage	MMSTA05 MMSTA06	V _{(BR)CEO}	60 80	—	V	I _C = 1.0mA, I _B = 0
Emitter-Base Breakdown Voltage		V _{(BR)EBO}	4.0	—	V	I _E = 100μA, I _C = 0
Collector Cutoff Current	MMSTA05 MMSTA06	I _{CBO}	—	100	nA	V _{CB} = 60V, I _E = 0 V _{CB} = 80V, I _E = 0
Collector Cutoff Current	MMSTA05 MMSTA06	I _{CES}	—	100	nA	V _{CE} = 60V, I _{BO} = 0V V _{CE} = 80V, I _{BO} = 0V
ON CHARACTERISTICS (Note 2)						
DC Current Gain		h _{FE}	100	—	—	I _C = 10mA, V _{CE} = 1.0V I _C = 100mA, V _{CE} = 1.0V
Collector-Emitter Saturation Voltage		V _{CE(SAT)}	—	0.25	V	I _C = 100mA, I _B = 10mA
Base-Emitter Saturation Voltage		V _{BE(SAT)}	—	1.2	V	I _C = 100mA, V _{CE} = 1.0V
SMALL SIGNAL CHARACTERISTICS						
Current Gain-Bandwidth Product		f _T	100	—	MHz	V _{CE} = 2.0V, I _C = 10mA, f = 100MHz

Ordering Information (Note 3)

Device	Packaging	Shipping
MMSTA05-7	SOT-323	3000/Tape & Reel
MMSTA06-7	SOT-323	3000/Tape & Reel

- Notes:
- Short duration test pulse used to minimize self-heating effect.
 - For Packaging Details, go to our website at <http://www.diodes.com/datasheets/ap02007.pdf>.
 - For Lead Free version (with Lead Free terminal finish) part number, please add "-F" suffix to part number above.
Example: MMSTA06-7-F.

Marking Information

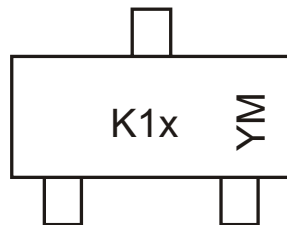

K1x = Product Type Marking Code, ex: K1H = MMSTA05
 YM = Date Code Marking
 Y = Year ex: N = 2002
 M = Month ex: 9 = September

Date Code Key

Year	1998	1999	2000	2001	2002	2003	2004	2005	2006	2007	2008	2009
Code	J	K	L	M	N	P	R	S	T	U	V	W

Month	Jan	Feb	March	Apr	May	Jun	Jul	Aug	Sep	Oct	Nov	Dec
Code	1	2	3	4	5	6	7	8	9	O	N	D

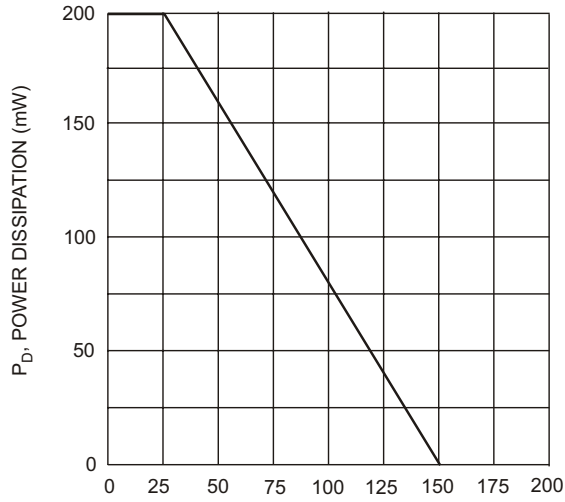

T_A, AMBIENT TEMPERATURE (°C)
Fig. 1, Max Power Dissipation vs Ambient Temperature

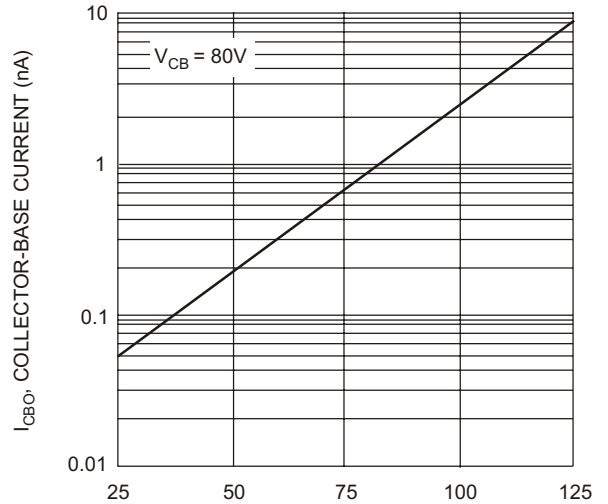

T_A, AMBIENT TEMPERATURE (°C)
Fig. 2 Typical Collector-Cutoff Current vs. Ambient Temperature

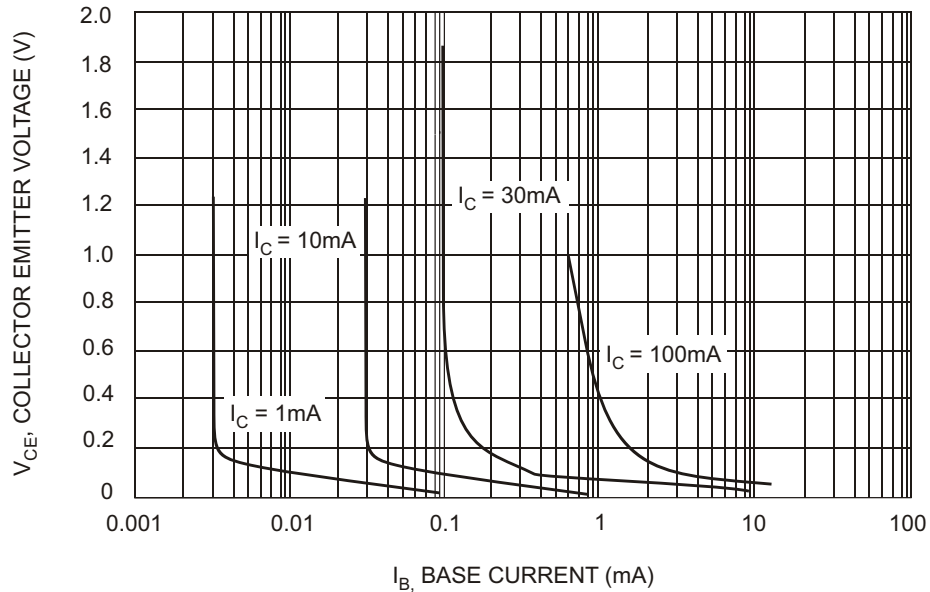

Fig. 3 Typical Collector Saturation Region

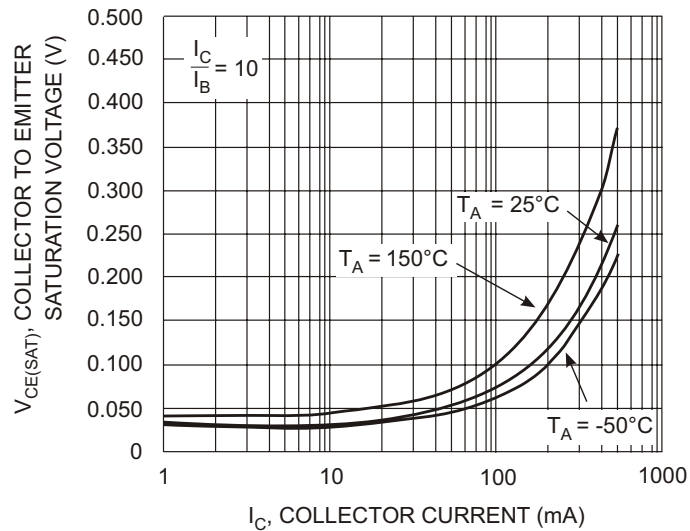

Fig. 4 Collector Emitter Saturation Voltage vs. Collector Current

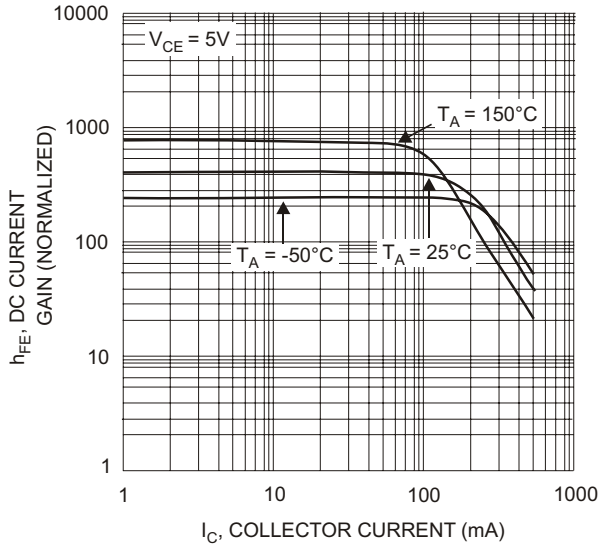

Fig. 5, DC Current Gain vs Collector Current

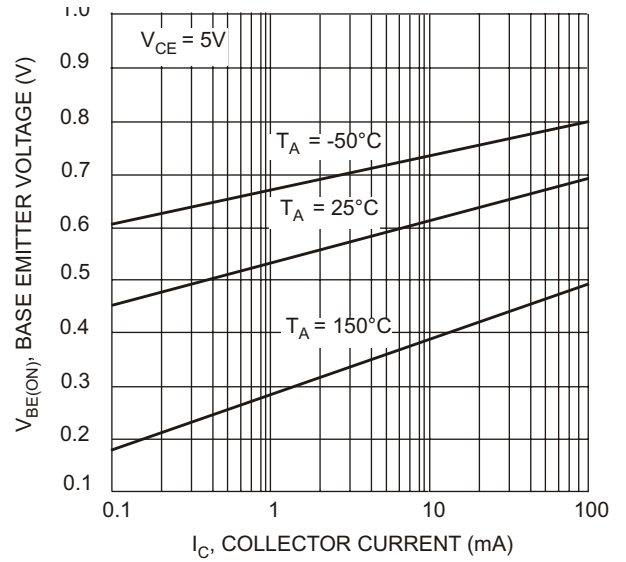

Fig. 6, Base Emitter Voltage vs Collector Current

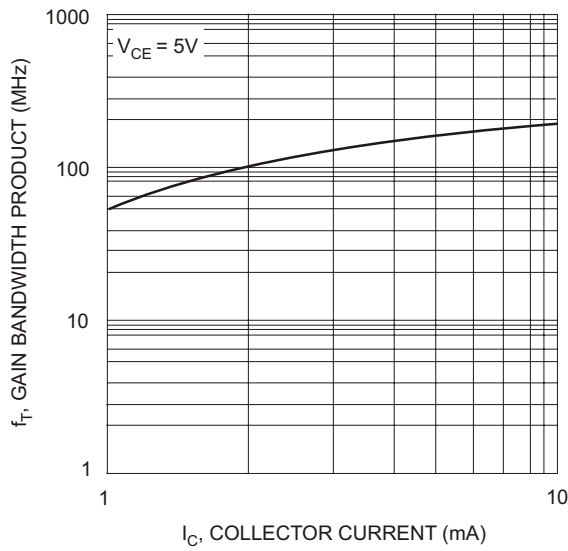

Fig. 7, Gain Bandwidth Product vs Collector Current