

### Features

- Epitaxial Planar Die Construction
- Complementary NPN Type Available (MMSTA42)
- Ideal for Medium Power Amplification and Switching
- Ultra-Small Surface Mount Package
- Also Available in Lead Free Version

### Mechanical Data

- Case: SOT-323, Molded Plastic
- Case Material - UL Flammability Rating 94V-0
- Moisture sensitivity: Level 1 per J-STD-020A
- Terminals: Solderable per MIL-STD-202, Method 208
- Also Available in Lead Free Plating (Matte Tin Finish). Please see Ordering Information, Note 4, on Page 2
- Terminal Connections: See Diagram
- Marking (See Page 2): K3R
- Ordering & Date Code Information: See Page 2
- Weight: 0.006 grams (approx.)

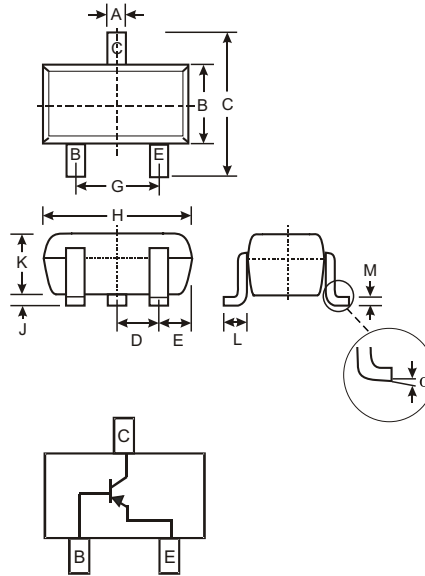

SOT-323		
Dim	Min	Max
A	0.25	0.40
B	1.15	1.35
C	2.00	2.20
D	0.65 Nominal	
E	0.30	0.40
G	1.20	1.40
H	1.80	2.20
J	0.0	0.10
K	0.90	1.00
L	0.25	0.40
M	0.10	0.18
$\alpha$	0°	8°
All Dimensions in mm		

### Maximum Ratings @ $T_A = 25^\circ\text{C}$ unless otherwise specified

Characteristic	Symbol	MMSTA92	Unit
Collector-Base Voltage	$V_{CBO}$	-300	V
Collector-Emitter Voltage	$V_{CEO}$	-300	V
Emitter-Base Voltage	$V_{EBO}$	-5.0	V
Collector Current (Note 1)	$I_C$	-100	mA
Power Dissipation (Note 1)	$P_d$	200	mW
Thermal Resistance, Junction to Ambient (Note 1)	$R_{\theta JA}$	625	K/W
Operating and Storage and Temperature Range	$T_j, T_{STG}$	-55 to +150	$^\circ\text{C}$

Note: 1. Device mounted on FR-4 PCB, 1 inch x 0.85 inch x 0.062 inch; pad layout as shown on Diodes Inc. suggested pad layout document AP02001, which can be found on our website at <http://www.diodes.com/datasheets/ap02001.pdf>.

## Electrical Characteristics @ $T_A = 25^\circ\text{C}$ unless otherwise specified

Characteristic	Symbol	Min	Max	Unit	Test Condition
<b>OFF CHARACTERISTICS (Note 2)</b>					
Collector-Base Breakdown Voltage	$V_{(BR)CBO}$	-300	—	V	$I_C = -100\mu\text{A}, I_E = 0$
Collector-Emitter Breakdown Voltage	$V_{(BR)CEO}$	-300	—	V	$I_C = -1.0\text{mA}, I_B = 0$
Emitter-Base Breakdown Voltage	$V_{(BR)EBO}$	-5.0	—	V	$I_E = -100\mu\text{A}, I_C = 0$
Collector Cutoff Current	$I_{CBO}$	—	-250	nA	$V_{CB} = -200\text{V}, I_E = 0$
Collector Cutoff Current	$I_{EBO}$	—	-100	nA	$V_{CE} = -3.0\text{V}, I_C = 0$
<b>ON CHARACTERISTICS (Note 2)</b>					
DC Current Gain	$h_{FE}$	25 40 25	—	—	$I_C = -1.0\text{mA}, V_{CE} = -10\text{V}$ $I_C = -10\text{mA}, V_{CE} = -10\text{V}$ $I_C = -30\text{mA}, V_{CE} = -10\text{V}$
Collector-Emitter Saturation Voltage	$V_{CE(SAT)}$	—	-0.5	V	$I_C = -20\text{mA}, I_B = -2.0\text{mA}$
Base- Emitter Saturation Voltage	$V_{BE(SAT)}$	—	-0.9	V	$I_C = -20\text{mA}, I_B = -2.0\text{mA}$
<b>SMALL SIGNAL CHARACTERISTICS</b>					
Output Capacitance	$C_{cb}$	—	6.0	pF	$V_{CB} = -20\text{V}, f = 1.0\text{MHz}, I_E = 0$
Current Gain-Bandwidth Product	$f_T$	50	—	MHz	$V_{CE} = -20\text{V}, I_C = -10\text{mA}, f = 100\text{MHz}$

## Ordering Information (Note 3)

Device	Packaging	Shipping
MMSTA92-7	SOT-323	3000/Tape & Reel

- Notes:
2. Short duration test pulse used to minimize self-heating effect.
  3. For Packaging Details, go to our website at <http://www.diodes.com/datasheets/ap02007.pdf>.
  4. For Lead Free version (with Lead Free terminal finish) part number, please add "-F" suffix to part number above.  
Example: MMSTA92-7-F.

## Marking Information

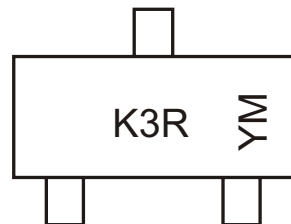

K3R = Product Type Marking Code  
 YM = Date Code Marking  
 Y = Year ex: N = 2002  
 M = Month ex: 9 = September

### Date Code Key

<b>Year</b>	1998	1999	2000	2001	2002	2003	2004	2005	2006	2007	2008	2009
<b>Code</b>	J	K	L	M	N	P	R	S	T	U	V	W
<b>Month</b>	Jan	Feb	March	Apr	May	Jun	Jul	Aug	Sep	Oct	Nov	Dec
<b>Code</b>	1	2	3	4	5	6	7	8	9	O	N	D

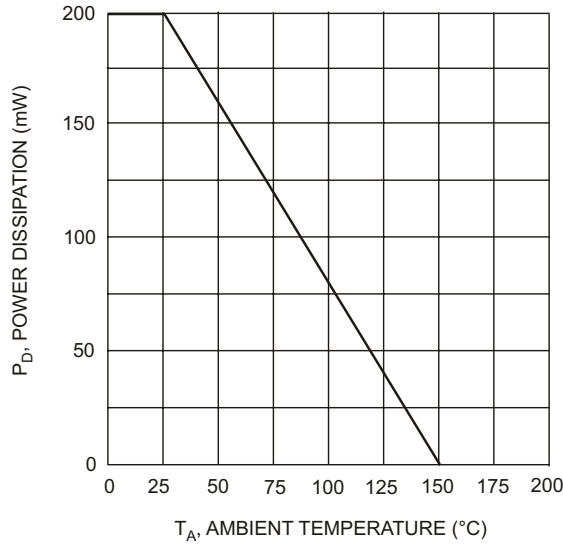

Fig. 1, Max Power Dissipation vs Ambient Temperature

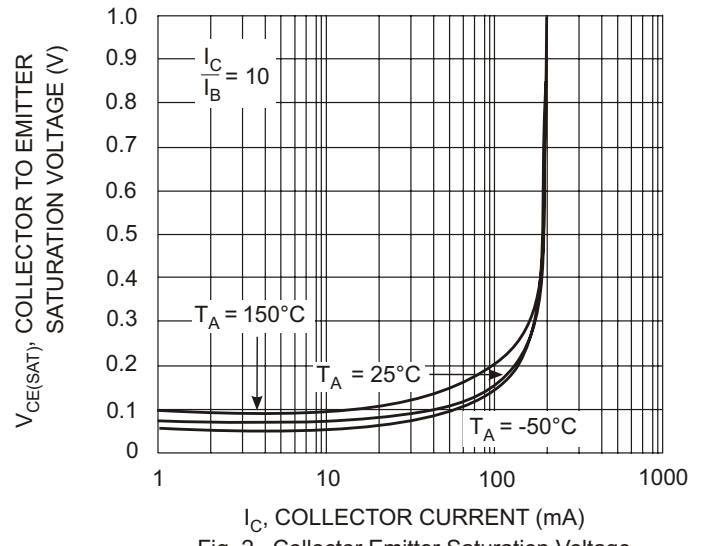

Fig. 2, Collector Emitter Saturation Voltage vs. Collector Current

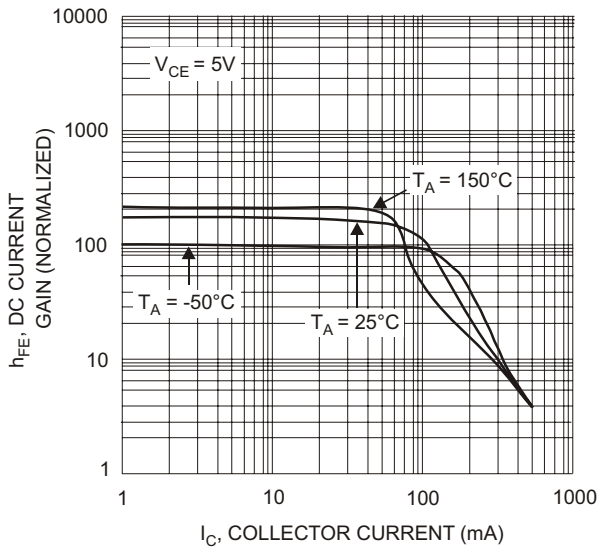

Fig. 3, DC Current Gain vs Collector Current

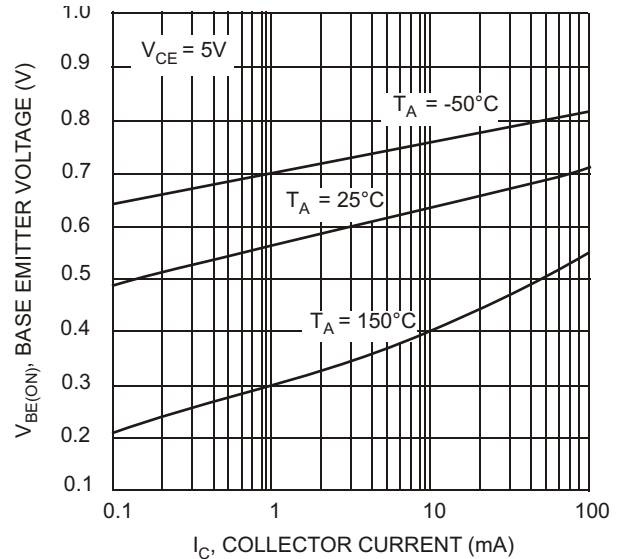

Fig. 4, Base Emitter Voltage vs Collector Current

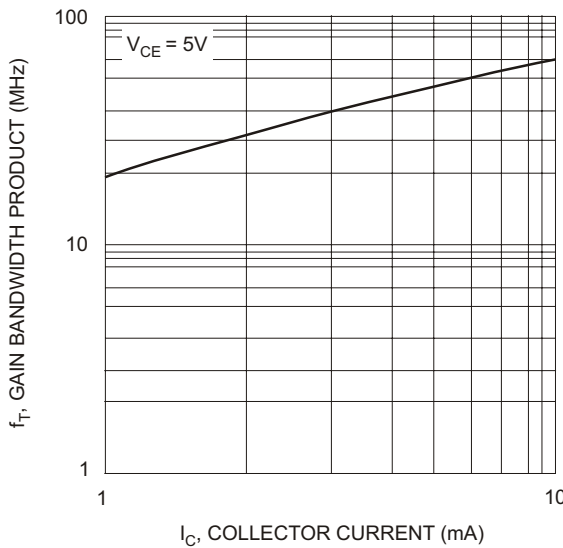

Fig. 5, Gain Bandwidth Product vs Collector Current