

# Low Current, High Performance NPN Silicon Bipolar Transistor

## Technical Data

### AT-32063

#### Features

- **High Performance Bipolar Transistor Optimized for Low Current, Low Voltage Operation**
- **900 MHz Performance:**  
1.1 dB NF, 14.5 dB G<sub>A</sub>
- **Characterized for End-of-Life Battery Use (2.7 V)**
- **SOT-363 (SC-70) Plastic Package**
- **Tape-and-Reel Packaging Option Available** <sup>[1]</sup>

#### Surface Mount Package SOT-363 (SC-70)

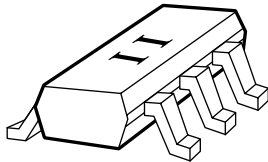

#### Pin Connections and Package Marking

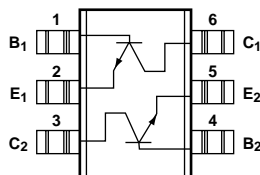

#### Description

The AT-32063 contains two high performance NPN bipolar transistors in a single SOT-363 package. The devices are unconnected, allowing flexibility in design. The pin-out is convenient for cascode amplifier designs. The SOT-363 package is an industry standard plastic surface mount package.

The 3.2 micron emitter-to-emitter pitch and reduced parasitic design of the transistor yields extremely high performance products that can perform a multiplicity of tasks. The 20 emitter finger interdigitated geometry yields a transistor that is easy to match to and extremely fast, with moderate power, low noise resistance, and low operating currents.

Optimized performance at 2.7 V makes this device ideal for use in 900 MHz, 1.8 GHz, and 2.4 GHz battery operated systems as an

LNA, gain stage, buffer, oscillator, or active mixer. Typical amplifier designs at 900 MHz yield 1.3 dB noise figures with 12 dB or more associated gain at a 2.7 V, 5 mA bias, with noise performance being relatively insensitive to input match. High gain capability at 1 V, 1 mA makes this device a good fit for 900 MHz pager applications. Voltage breakdowns are high enough for use at 5 volts.

The AT-3 series bipolar transistors are fabricated using an optimized version of Hewlett-Packard's 10 GHz  $f_t$ , 30 GHz  $f_{max}$  Self-Aligned-Transistor (SAT) process. The die are nitride passivated for surface protection. Excellent device uniformity, performance and reliability are produced by the use of ion-implantation, self-alignment techniques, and gold metallization in the fabrication of these devices.

## AT-32063 Absolute Maximum Ratings<sup>[1]</sup>

Symbol	Parameter	Units	Absolute Maximum
$V_{EBO}$	Emitter-Base Voltage	V	1.5
$V_{CBO}$	Collector-Base Voltage	V	11
$V_{CEO}$	Collector-Emitter Voltage	V	5.5
$I_C$	Collector Current	mA	40
$P_T$	Power Dissipation <sup>[2,3]</sup>	mW	150
$T_j$	Junction Temperature	°C	150
$T_{STG}$	Storage Temperature	°C	-65 to 150

### Thermal Resistance<sup>[2]</sup>:

$$\theta_{jc} = 370^\circ\text{C/W}$$

#### Notes:

1. Permanent damage may occur if any of these limits are exceeded.
2.  $T_{\text{Mounting Surface}} = 25^\circ\text{C}$ .
3. Derate at 2.7 mW/°C for  $T_C > 94.5^\circ\text{C}$ .
4. 150 mW per device.

## Electrical Specifications, $T_A = 25^\circ\text{C}$

Symbol	Parameters and Test Conditions	Units	Min.	Typ.	Max.
NF	Noise Figure; $V_{CE} = 2.7\text{ V}$ , $I_C = 5\text{ mA}$ <span style="float: right;"><math>f = 0.9\text{ GHz}</math></span>	dB		1.1 <sup>[2]</sup>	1.4 <sup>[2]</sup>
$G_A$	Associated Gain; $V_{CE} = 2.7\text{ V}$ , $I_C = 5\text{ mA}$ <span style="float: right;"><math>f = 0.9\text{ GHz}</math></span>	dB	12.5 <sup>[2]</sup>	14.5 <sup>[2]</sup>	
$h_{FE}$	Forward Current Transfer Ratio; $V_{CE} = 2.7\text{ V}$ , $I_C = 5\text{ mA}$	—	50		270
$I_{CBO}$	Collector Cutoff Current; $V_{CB} = 3\text{ V}$	$\mu\text{A}$			0.2
$I_{EBO}$	Noise Figure; $V_{EB} = 1\text{ V}$	$\mu\text{A}$			1.5

#### Notes:

1. All data is per individual transistor.
2. Test circuit, Figure 1. Numbers reflect device performance de-embedded from circuit losses. Input loss = 0.2 dB; output loss = 0.3 dB.

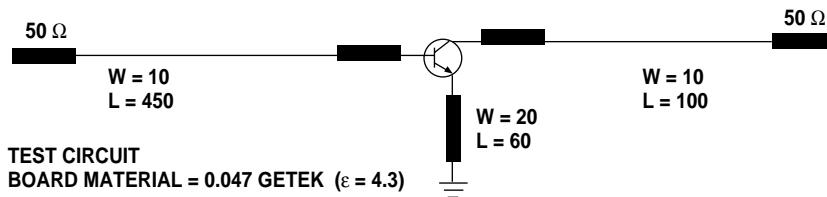

DIMENSIONS IN MILS  
NOT TO SCALE

**Figure 1. Test circuit for Noise Figure and Associated Gain.**  
This circuit is a compromise match between best noise figure, best gain, stability, and a practical synthesizable match.

## AT-32063 Characterization Information, $T_A = 25^\circ\text{C}$

Symbol	Parameters and Test Conditions	Units	Typ.
$P_{1\text{dB}}$	Power at 1 dB Gain Compression (opt tuning); $V_{\text{CE}} = 2.7\text{ V}$ , $I_C = 20\text{ mA}$ $f = 0.9\text{ GHz}$	dBm	12
$G_{1\text{dB}}$	Gain at 1 dB Gain Compression (opt tuning); $V_{\text{CE}} = 2.7\text{ V}$ , $I_C = 20\text{ mA}$ $f = 0.9\text{ GHz}$	dB	16
$IP_3$	Output Third Order Intercept Point (opt tuning); $V_{\text{CE}} = 2.7\text{ V}$ , $I_C = 20\text{ mA}$ $f = 0.9\text{ GHz}$	dBm	24

### Typical Performance, $T_A = 25^\circ\text{C}$

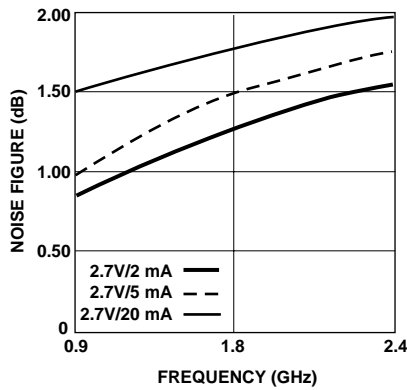

Figure 2. Minimum Noise Figure vs. Frequency and Current at  $V_{\text{CE}} = 2.7\text{ V}$ .

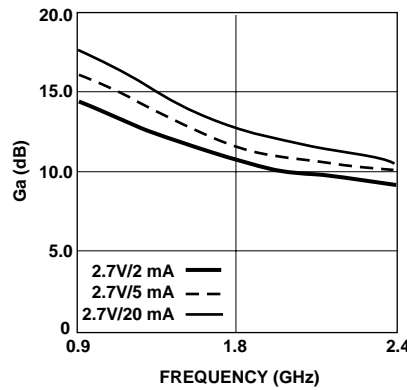

Figure 3. Associated Gain at Optimum Noise Match vs. Frequency and Current at  $V_{\text{CE}} = 2.7\text{ V}$ .

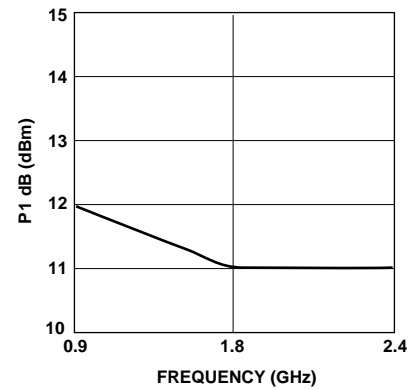

Figure 4. Power at 1 dB Gain Compression vs. Frequency at  $V_{\text{CE}} = 2.7\text{ V}$  and  $I_C = 20\text{ mA}$ .

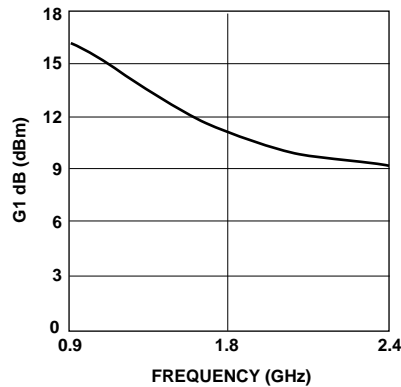

Figure 5. 1 dB Compressed Gain vs. Frequency at  $V_{\text{CE}} = 2.7\text{ V}$  and  $I_C = 20\text{ mA}$ .

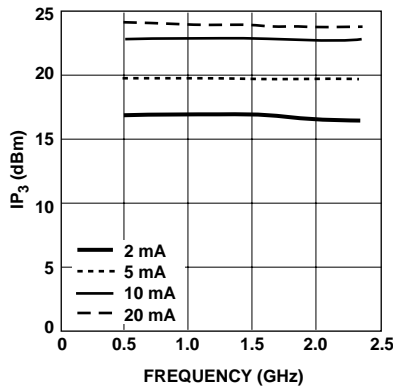

Figure 6. Third Order Intercept vs. Frequency and Bias at  $V_{\text{CE}} = 2.7\text{ V}$ , with Optimal Tuning.

**AT-32063 Typical Scattering Parameters, Common Emitter,  $Z_0 = 50 \Omega$ ,  $V_{CE} = 1 \text{ V}$ ,  $I_C = 1 \text{ mA}$**

Freq. GHz	$S_{11}$		$S_{21}$			$S_{12}$			$S_{22}$	
	Mag	Ang	dB	Mag	Ang	dB	Mag	Ang	Mag	Ang
0.1	0.98	-11	11.36	3.7	171	-34.77	0.02	83	0.99	-4
0.5	0.86	-50	10.14	3.21	138	-22.02	0.08	59	0.91	-20
0.9	0.72	-82	8.39	2.63	113	-18.97	0.11	43	0.82	-31
1.0	0.69	-88	7.87	2.48	108	-18.61	0.12	41	0.8	-32
1.5	0.58	-119	5.87	1.97	85	-17.8	0.13	31	0.73	-41
1.8	0.52	-134	4.83	1.74	74	-17.72	0.13	28	0.7	-45
2.0	0.49	-145	4.3	1.64	67	-17.69	0.13	28	0.68	-48
2.4	0.45	-165	3.16	1.44	55	-17.68	0.13	30	0.67	-54
3.0	0.41	166	1.84	1.24	39	-16.99	0.14	37	0.64	-63
4.0	0.42	124	0.17	1.02	16	-13.67	0.21	45	0.6	-81
5.0	0.47	93	-1.15	0.88	-2	-9.84	0.32	38	0.54	-107

**AT-32063 Typical Noise Parameters**

Common Emitter,  $Z_0 = 50 \Omega$ ,  $V_{CE} = 1 \text{ V}$ ,  $I_C = 1 \text{ mA}$

Freq. GHz	$F_{min}$ dB	$G_A$ dB	$G_{opt}$ Mag.	Ang.	$R_n$ —
0.9	0.71	10.4	0.76	50	0.44
1.8	1.37	8.3	0.60	112	0.24
2.4	1.80	7.2	0.50	155	0.10

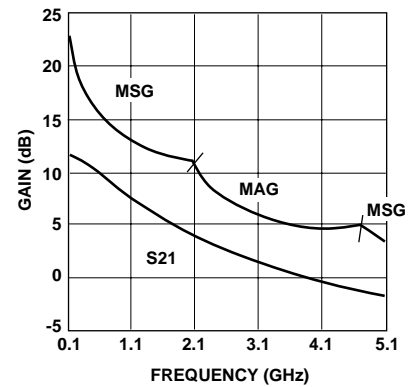

**Figure 7. Gain vs. Frequency at  $V_{CE}=1\text{V}$ ,  $I_C = 1\text{mA}$ .**

**AT-32063 Typical Scattering Parameters, Common Emitter,  $Z_0 = 50 \Omega$ ,  $V_{CE} = 2.7 \text{ V}$ ,  $I_C = 2 \text{ mA}$**

Freq. GHz	$S_{11}$		$S_{21}$			$S_{12}$			$S_{22}$	
	Mag	Ang	dB	Mag	Ang	dB	Mag	Ang	Mag	Ang
0.1	0.96	-12	16.46	6.66	169	-37.32	0.014	82	0.98	-5
0.5	0.77	-55	14.73	5.45	132	-25.13	0.055	59	0.87	-21
0.9	0.59	-87	12.37	4.15	107	-22.42	0.076	48	0.76	-29
1.0	0.55	-93	11.74	3.86	103	-22.07	0.079	47	0.74	-30
1.5	0.42	-121	9.26	2.90	83	-20.79	0.091	44	0.69	-36
1.8	0.37	-135	8.01	2.52	73	-20.13	0.099	45	0.67	-39
2.0	0.34	-145	7.35	2.33	67	-19.67	0.104	46	0.66	-41
2.4	0.29	-164	6.05	2.01	56	-18.68	0.116	48	0.65	-46
3.0	0.26	167	4.54	1.69	41	-16.95	0.142	50	0.64	-53
4.0	0.28	124	2.73	1.37	20	-13.75	0.205	48	0.61	-68
5.0	0.33	94	1.36	1.17	1	-10.70	0.292	41	0.57	-89

**AT-32063 Typical Noise Parameters**

Common Emitter,  $Z_0 = 50 \Omega$ ,  $V_{CE} = 2.7 \text{ V}$ ,  $I_C = 2 \text{ mA}$

Freq. GHz	$F_{min}$ dB	$G_A$ dB	$G_{opt}$ Mag.	Ang.	$R_n$ —
0.9	0.78	14.3	0.65	50	0.31
1.8	1.25	10.7	0.45	105	0.20
2.4	1.57	9.1	0.35	145	0.13

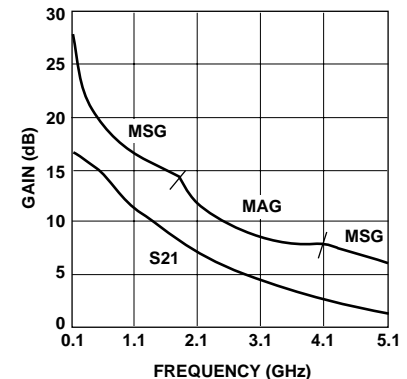

**Figure 8. Gain vs. Frequency at  $V_{CE}=2.7 \text{ V}$ ,  $I_C = 2\text{mA}$ .**

**AT-32063 Typical Scattering Parameters, Common Emitter,  $Z_0 = 50 \Omega$ ,  $V_{CE} = 2.7 \text{ V}$ ,  $I_C = 5 \text{ mA}$**

Freq. GHz	$S_{11}$		$S_{21}$			$S_{12}$			$S_{22}$	
	Mag	Ang	dB	Mag	Ang	dB	Mag	Ang	Mag	Ang
0.1	0.87	-19	23.36	14.72	162	-37.77	0.013	80	0.96	-9
0.5	0.52	-72	19.21	9.13	116	-27.03	0.045	60	0.72	-25
0.9	0.34	-101	15.40	5.89	94	-24.01	0.063	58	0.62	-28
1.0	0.31	-106	14.60	5.37	90	-23.41	0.067	58	0.61	-29
1.5	0.22	-129	11.54	3.77	74	-20.85	0.091	58	0.58	-33
1.8	0.19	-141	10.12	3.21	66	-19.52	0.106	58	0.57	-36
2.0	0.17	-150	9.33	2.93	61	-18.72	0.116	57	0.57	-38
2.4	0.14	-169	7.95	2.50	52	-17.22	0.138	56	0.57	-42
3.0	0.12	160	6.34	2.08	39	-15.25	0.173	52	0.56	-49
4.0	0.16	117	4.46	1.67	20	-12.40	0.240	44	0.53	-63
5.0	0.22	93	3.15	1.44	2	-10.03	0.315	33	0.48	-82

**AT-32063 Typical Noise Parameters**

Common Emitter,  $Z_0 = 50 \Omega$ ,  $V_{CE} = 2.7 \text{ V}$ ,  $I_C = 5 \text{ mA}$

Freq. GHz	$F_{min}$ dB	$G_A$ dB	$G_{opt}$ Mag.	Ang.	$R_n$ —
0.9	0.98	16.4	0.45	51	0.23
1.8	1.50	11.6	0.29	100	0.16
2.4	1.77	10.1	0.33	153	0.11

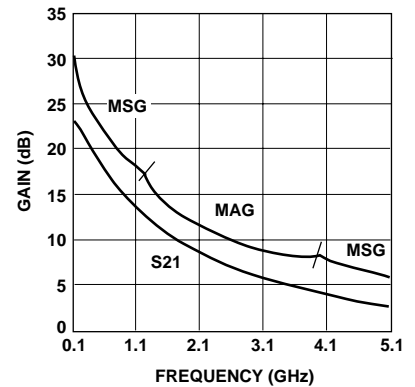

**Figure 9. Gain vs. Frequency at  $V_{CE}=2.7 \text{ V}$ ,  $I_C = 5 \text{ mA}$ .**

**AT-32063 Typical Scattering Parameters, Common Emitter,  $Z_0 = 50 \Omega$ ,  $V_{CE} = 2.7 \text{ V}$ ,  $I_C = 20 \text{ mA}$**

Freq. GHz	$S_{11}$		$S_{21}$			$S_{12}$			$S_{22}$	
	Mag	Ang	dB	Mag	Ang	dB	Mag	Ang	Mag	Ang
0.1	0.55	-41	30.48	33.40	143	-39.81	0.010	74	0.83	-15
0.5	0.20	-107	21.24	11.53	97	-29.18	0.035	72	0.56	-20
0.9	0.13	-137	16.48	6.66	82	-24.63	0.059	72	0.53	-22
1.0	0.13	-141	15.60	6.02	79	-23.79	0.065	71	0.53	-22
1.5	0.10	-164	12.26	4.10	67	-20.43	0.095	68	0.52	-27
1.8	0.09	-178	10.78	3.46	60	-18.88	0.114	66	0.53	-31
2.0	0.09	172	9.93	3.14	56	-17.98	0.126	64	0.53	-34
2.4	0.08	152	8.52	2.67	48	-16.39	0.151	60	0.53	-39
3.0	0.10	127	6.85	2.20	36	-14.4	0.191	54	0.52	-47
4.0	0.15	101	4.92	1.76	18	-11.68	0.261	43	0.48	-61
5.0	0.21	86	3.59	1.51	0	-9.52	0.334	31	0.44	-79

**AT-32063 Typical Noise Parameters**

Common Emitter,  $Z_0 = 50 \Omega$ ,  $V_{CE} = 2.7 \text{ V}$ ,  $I_C = 20 \text{ mA}$

Freq. GHz	$F_{min}$ dB	$G_A$ dB	$G_{opt}$ Mag.	Ang.	$R_n$ —
0.9	1.51	17.9	0.13	88	0.20
1.8	1.78	12.7	0.20	178	0.13
2.4	1.96	10.6	0.28	235	0.08

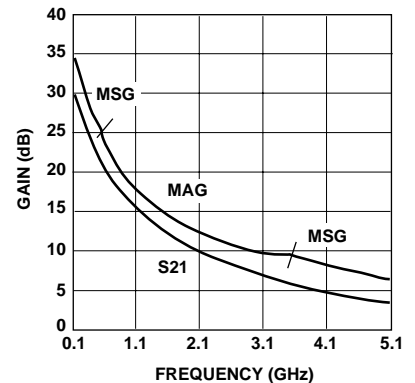

**Figure 10. Gain vs. Frequency at  $V_{CE}=2.7 \text{ V}$ ,  $I_C = 20 \text{ mA}$ .**

**AT-32063 Typical Scattering Parameters, Common Emitter,  $Z_o = 50 \Omega$ ,  $V_{CE} = 5 \text{ V}$ ,  $I_C = 2 \text{ mA}$**

Freq. GHz	$S_{11}$		$S_{21}$			$S_{12}$			$S_{22}$	
	Mag	Ang	dB	Mag	Ang	dB	Mag	Ang	Mag	Ang
0.1	0.96	-12	16.50	6.69	169	-38.44	0.012	82	0.98	-5
0.5	0.78	-53	14.84	5.52	133	-26.20	0.049	60	0.88	-19
0.9	0.59	-84	12.5	4.23	108	-23.4	0.068	50	0.79	-27
1.0	0.56	-90	11.92	3.94	104	-23.04	0.070	49	0.77	-28
1.5	0.42	-117	9.46	2.97	84	-21.71	0.082	46	0.72	-33
1.8	0.36	-131	8.21	2.57	74	-21.04	0.089	47	0.70	-36
2.0	0.33	-140	7.55	2.38	68	-20.56	0.094	48	0.69	-39
2.4	0.28	-159	6.24	2.05	57	-19.54	0.105	50	0.69	-43
3.0	0.24	171	4.72	1.72	43	-17.76	0.129	53	0.68	-50
4.0	0.25	126	2.88	1.39	21	-14.47	0.189	52	0.66	-64
5.0	0.31	95	1.49	1.19	3	-11.32	0.272	45	0.63	-83

**AT-32063 Typical Noise Parameters**

Common Emitter,  $Z_o = 50 \Omega$ ,  $V_{CE} = 5 \text{ V}$ ,  $I_C = 2 \text{ mA}$

Freq. GHz	$F_{min}$ dB	$G_A$ dB	$G_{opt}$ Mag.	Ang.	$R_n$ —
0.9	0.75	13.7	0.74	47	0.37
1.8	1.26	10.8	0.55	101	0.22
2.4	1.60	9.6	0.45	139	0.13

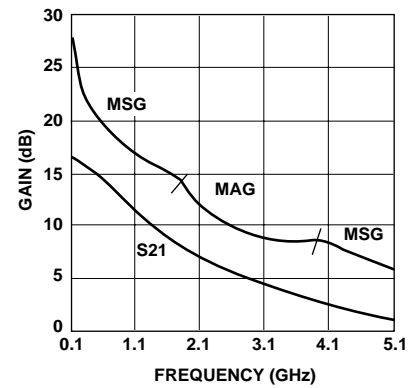

**Figure 11. Gain vs. Frequency at  $V_{CE}=5 \text{ V}$ ,  $I_C = 2 \text{ mA}$ .**

**AT-32063 Typical Scattering Parameters, Common Emitter,  $Z_o = 50 \Omega$ ,  $V_{CE} = 5 \text{ V}$ ,  $I_C = 20 \text{ mA}$**

Freq. GHz	$S_{11}$		$S_{21}$			$S_{12}$			$S_{22}$	
	Mag	Ang	dB	Mag	Ang	dB	Mag	Ang	Mag	Ang
0.1	0.61	-36	30.56	33.74	145	-40.46	0.01	75	0.86	-14
0.5	0.22	-91	21.75	12.23	98	-29.90	0.03	72	0.6	-19
0.9	0.13	-115	17.02	7.10	83	-25.40	0.05	72	0.57	-21
1.0	0.12	-118	16.14	6.41	81	-24.56	0.06	71	0.57	-21
1.5	0.08	-137	12.80	4.36	68	-21.23	0.09	69	0.57	-26
1.8	0.06	-148	11.31	3.68	62	-19.69	0.10	66	0.57	-30
2.0	0.06	-159	10.46	3.33	58	-18.79	0.12	65	0.57	-32
2.4	0.04	175	9.02	2.83	50	-17.21	0.14	61	0.57	-37
3.0	0.05	131	7.35	2.33	39	-15.22	0.17	56	0.56	-45
4.0	0.10	99	5.39	1.86	21	-12.48	0.24	46	0.54	-58
5.0	0.16	86	4.05	1.6	3	-10.27	0.31	34	0.50	-75

**AT-32063 Typical Noise Parameters**

Common Emitter,  $Z_o = 50 \Omega$ ,  $V_{CE} = 5 \text{ V}$ ,  $I_C = 20 \text{ mA}$

Freq. GHz	$F_{min}$ dB	$G_A$ dB	$G_{opt}$ Mag.	Ang.	$R_n$ —
0.9	1.50	18.6	0.18	74	0.20
1.8	1.78	13.3	0.19	147	0.16
2.4	1.96	11.3	0.24	198	0.14

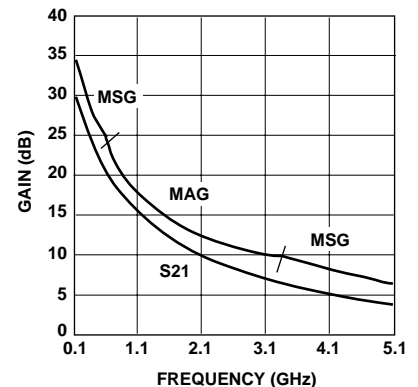

**Figure 12. Gain vs. Frequency at  $V_{CE}=5 \text{ V}$ ,  $I_C = 20 \text{ mA}$ .**



## Device Orientation

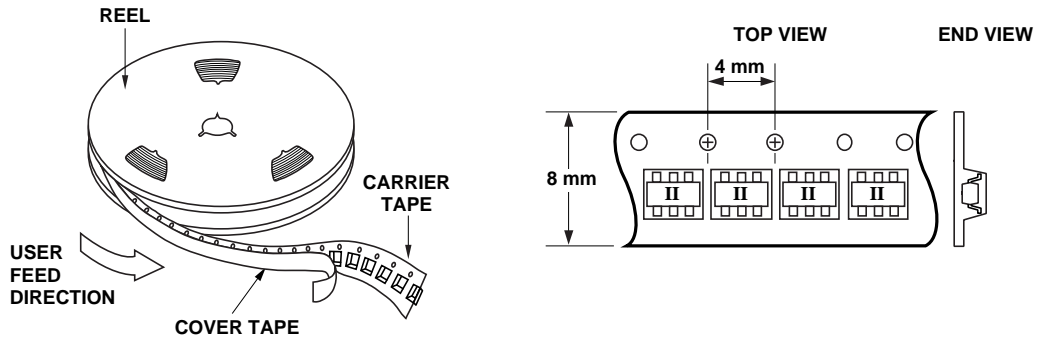

## Tape Dimensions For Outline 63

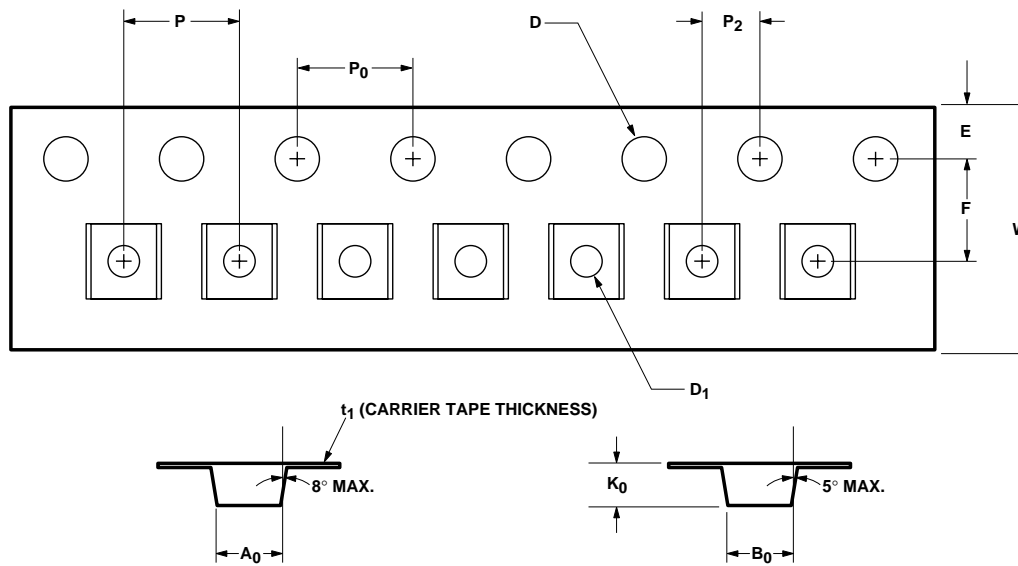

DESCRIPTION		SYMBOL	SIZE (mm)	SIZE (INCHES)
CAVITY	LENGTH	A <sub>0</sub>	2.24 ± 0.10	0.088 ± 0.004
	WIDTH	B <sub>0</sub>	2.34 ± 0.10	0.092 ± 0.004
	DEPTH	K <sub>0</sub>	1.22 ± 0.10	0.048 ± 0.004
	PITCH	P	4.00 ± 0.10	0.157 ± 0.004
	BOTTOM HOLE DIAMETER	D <sub>1</sub>	1.00 + 0.25	0.039 + 0.010
PERFORATION	DIAMETER	D	1.55 ± 0.05	0.061 ± 0.002
	PITCH	P <sub>0</sub>	4.00 ± 0.10	0.157 ± 0.004
	POSITION	E	1.75 ± 0.10	0.069 ± 0.004
CARRIER TAPE	WIDTH	W	8.00 ± 0.30	0.315 ± 0.012
	THICKNESS	t <sub>1</sub>	0.255 ± 0.013	0.010 ± 0.0005
DISTANCE	CAVITY TO PERFORATION (WIDTH DIRECTION)	F	3.50 ± 0.05	0.138 ± 0.002
	CAVITY TO PERFORATION (LENGTH DIRECTION)	P <sub>2</sub>	2.00 ± 0.05	0.079 ± 0.002