

# T-13/4 (5 mm), Wide Viewing Angle, High Intensity LED Lamps

## Technical Data

**HLMA-VH00**  
**HLMA-VL00**  
**HLMP-V100**  
**HLMP-V500**

### Features

- Outstanding LED Material Efficiency
- Extremely Wide Horizontal Viewing Angle
- High Light Output over a Wide Range of Currents
- Untinted, Non-diffused Lens
- Choice of Four Colors: 644 nm Red, 590 nm Amber, 570 nm Green, and 615 nm Orange

### Description

These high intensity LED lamps provide the user with an extremely wide 60° (horizontal) by 30° (vertical) oval shaped radiation pattern. Available in TS AlGaAs red, AlInGaP amber, AlInGaP orange, and GaP green colors, these untinted non-diffused T-1<sup>3</sup>/<sub>4</sub> (5 mm) LEDs are an excellent choice for outdoor applications requiring an extremely wide field of vision and high brightness.

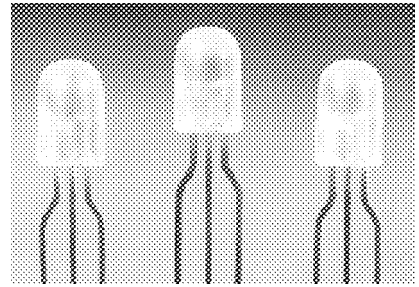

### Applications

- Outdoor Message Boards
- Safety Lighting Equipment
- Changeable Message Signs
- Alternative to Incandescent Lamps

### Outline Drawing

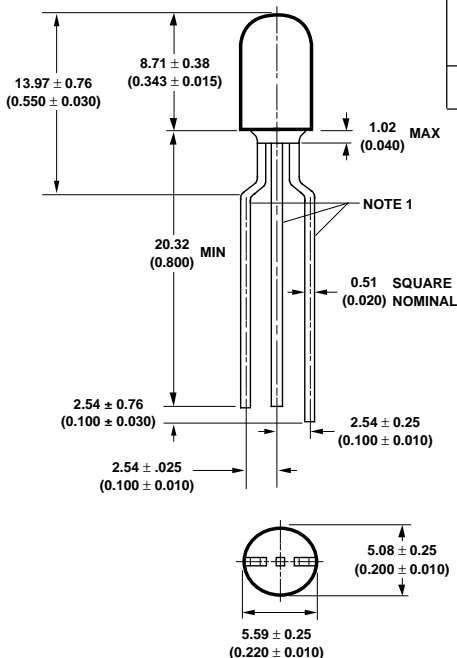

### Device Selection Guide

Amber $\lambda_d = 590 \text{ nm}$	Red-Orange $\lambda_d = 615 \text{ nm}$	Red $\lambda_d = 644 \text{ nm}$	Green $\lambda_d = 570 \text{ nm}$
HLMA-VL00	HLMA-VH00	HLMP-V100	HLMP-V500

#### NOTES:

##### 1. LEAD ORIENTATION:

DEVICE TYPE	CENTER LEAD	OUTER LEADS
HLMP-V100	COMMON ANODE	CATHODE
HLMP-V500	COMMON CATHODE	ANODE
HLMA-VL00	COMMON CATHODE	ANODE
HLMA-VH00	COMMON CATHODE	ANODE

##### 2. ALL DIMENSIONS ARE IN MM (INCHES).

### Absolute Maximum Ratings at $T_A = 25^\circ\text{C}$

Parameter	HLMA-VL00	HLMA-VH00	HLMP-V100	HLMP-V500	Units
DC Forward Current <sup>[1,3]</sup>	60 <sup>[4,5]</sup>	60 <sup>[4,5]</sup>	60	50	mA
Peak Forward Current <sup>[2,3]</sup>	400	400	600	180	mA
Average Input Power <sup>[2]</sup>	120	120	120	110	mW
Reverse Voltage ( $I_R = 200 \mu\text{A}$ )	5	5	5	5	V
Operating Temperature Range	-40 to +100	-40 to +100	-55 to +85	-20 to +100	$^\circ\text{C}$
Storage Temperature Range	-55 to +100	-55 to +100	-55 to +100	-55 to +100	$^\circ\text{C}$
Junction Temperature	110				$^\circ\text{C}$
Soldering Temperature [1.59 mm (0.06 in.) below seating plane]	260 $^\circ\text{C}$ for 5 seconds				

**Notes:**

- Derate linearly as shown in Figure 5.
- Any pulsed operation cannot exceed the Absolute Max Peak Forward Current or the Max Allowable Average Power as specified in Figure 6.
- Specified with both die powered simultaneously.
- Drive Currents between 10 mA and 30 mA are recommended for best long term performance.
- Operation at currents below 10 mA is not recommended, please contact your Hewlett-Packard sales representative.

### Optical Characteristics at $T_A = 25^\circ\text{C}$

Part Number	Luminous Intensity $I_V$ (mcd) @ 40 mA <sup>[1]</sup>		Peak Wavelength $\lambda_{\text{peak}}$ (nm) Typ.	Color, Dominant Wavelength $\lambda_d$ <sup>[2]</sup> (nm) Typ.	Viewing Angle $2\theta_{1/2}$ Degrees <sup>[3]</sup> Typ.	Luminous Efficacy $\eta_V$ (lm/w)
	Min.	Typ.				
HLMA-VL00	212	460	592	590	60° horizontal 30° vertical	480
HLMA-VH00	200	460	621	615		263
HLMP-V100	500	1000	654	644	60° horizontal 30° vertical	85
HLMP-V500	112	270	568	570	60° horizontal 30° vertical	595

**Notes:**

- The luminous intensity,  $I_V$ , is measured at the mechanical axis of the lamp package. The actual peak of the spatial radiation pattern may not be aligned with this axis.
- The dominant wavelength,  $\lambda_d$ , is derived from the CIE Chromaticity Diagram and represents the color of the device.
- $2\theta_{1/2}$  is the off-axis angle where the luminous intensity is 1/2 the on-axis intensity.

### Electrical Characteristics at $T_A = 25^\circ\text{C}$

Part Number	Forward Voltage $V_F$ (Volts) @ $I_F = 40 \text{ mA}$		Reverse Breakdown $V_R$ (Volts) @ $I_R = 200 \mu\text{A}$ Min.	Capacitance $C$ (pF) $V_F = 0$ , $f = 1 \text{ MHz}$ Typ.	Thermal Resistance $R_{\theta\text{J-PIN}}$ ( $^\circ\text{C}/\text{W}$ )	Speed of Response $\tau_s$ (ns) Time Constant $e^{-t/\tau_s}$ Typ.
	Typ.	Max.				
HLMA-VL00	1.90	2.4	5	120	100	13
HLMA-VH00	1.90	2.4	5	120	100	13
HLMP-V100	1.85	2.4	5	50	115	26
HLMP-V500	2.20	3.0	5	20	100	171

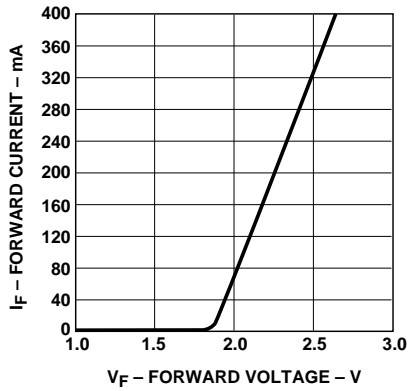

Figure 2a. Forward Current vs. Forward Voltage, HLMA-VL00/VH00.

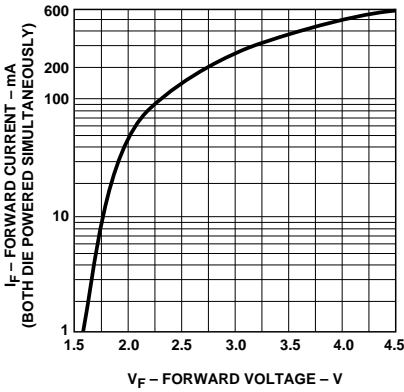

Figure 2b. Forward Current vs. Forward Voltage, HLMP-V100.

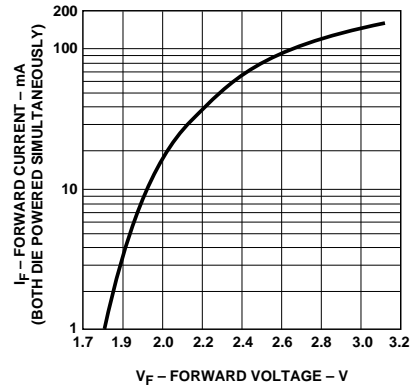

Figure 2c. Forward Current vs. Forward Voltage, HLMP-V500.

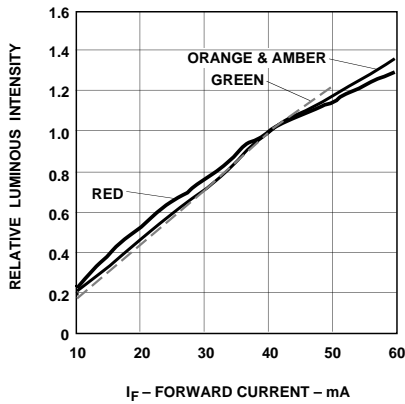

Figure 3. Relative Luminous Intensity vs. Forward Current.

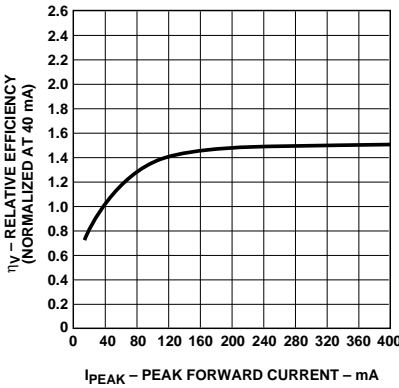

Figure 4a. Relative Efficiency vs. Peak Forward Current, HLMA-VL00/VH00.

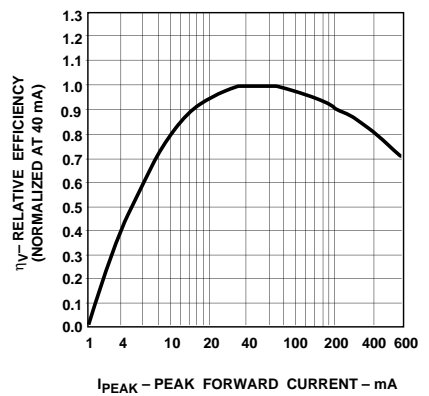

Figure 4b. Relative Efficiency vs. Peak Forward Current, HLMP-V100.

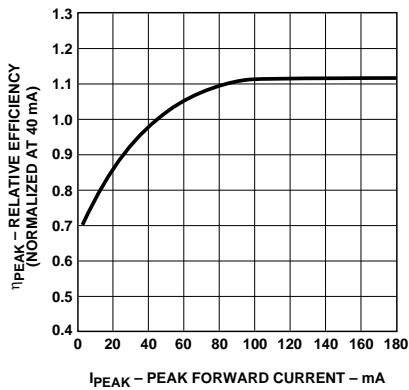

Figure 4c. Relative Efficiency vs. Peak Forward Current, HLMP-V500.

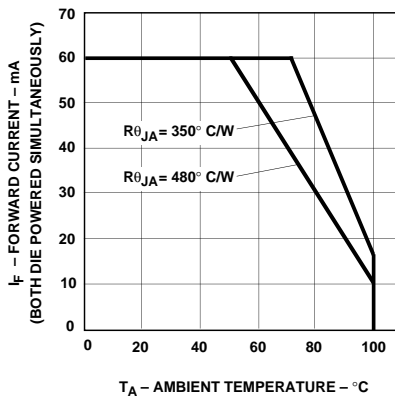

Figure 5a. Maximum Forward DC Current vs. Ambient Temperature, HLMA-VL00/VH00.

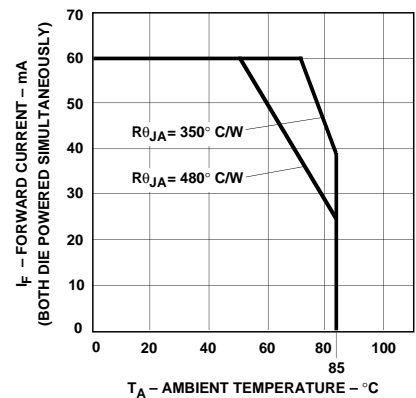

Figure 5b. Maximum Forward DC Current vs. Ambient Temperature, HLMP-V100.

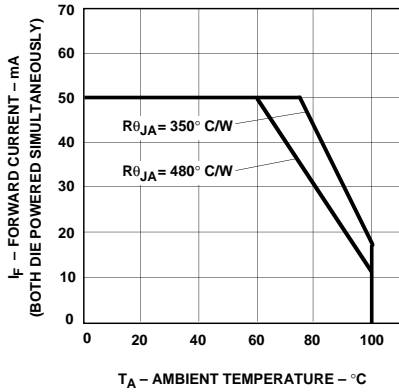

Figure 5c. Maximum Forward DC Current vs. Ambient Temperature, HLMP-V500.

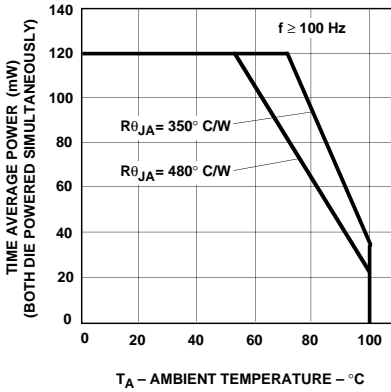

Figure 6a. Maximum Allowable Average Power vs. Ambient Temperature, HLMA-VL00/VH00.

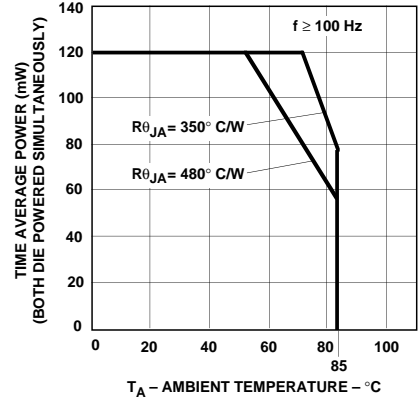

Figure 6b. Maximum Allowable Average Power vs. Ambient Temperature, HLMP-V100.

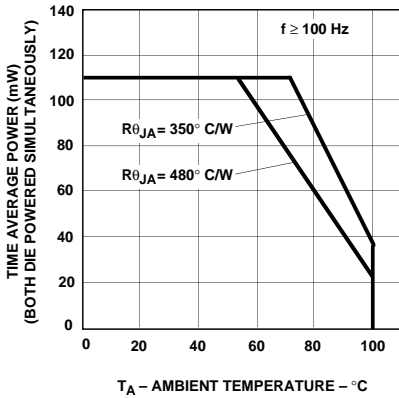

Figure 6c. Maximum Allowable Average Power vs. Ambient Temperature, HLMP-V500.

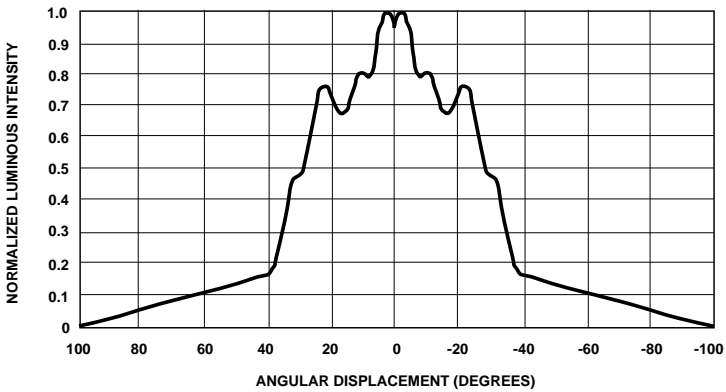

Figure 7a. Relative Intensity vs. Angle, HLMA-VL00/VH00 Horizontal Axis.

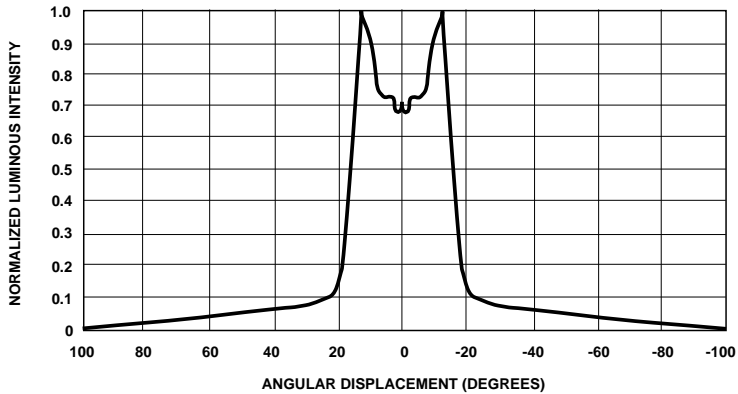

Figure 7b. Relative Intensity vs. Angle, HLMA-VL00/VH00 Vertical Axis.

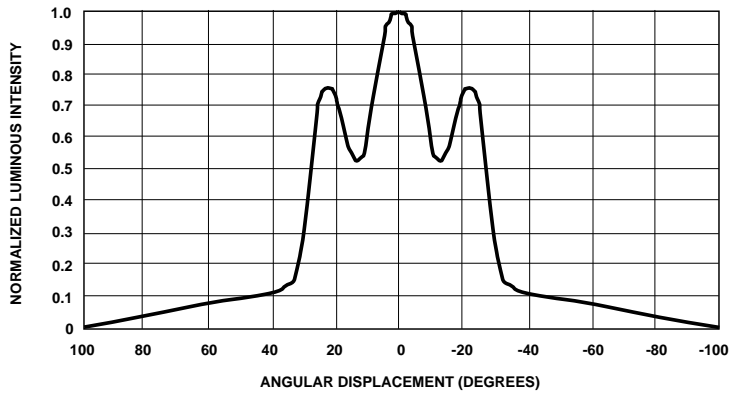

Figure 8a. Relative Intensity vs. Angle, HLMP-V100 Horizontal Axis.

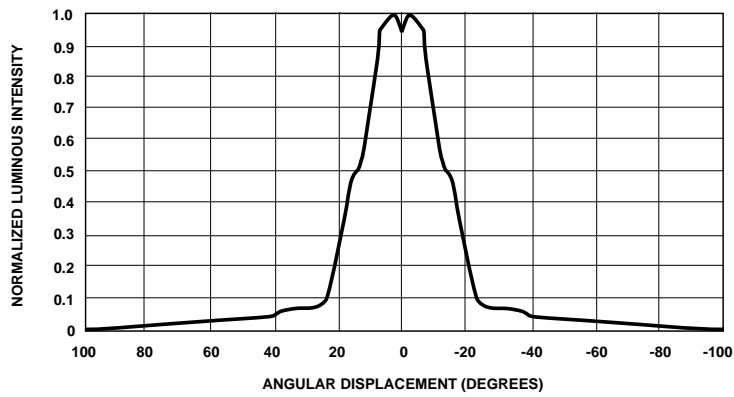

Figure 8b. Relative Intensity vs. Angle, HLMP-V100 Vertical Axis.

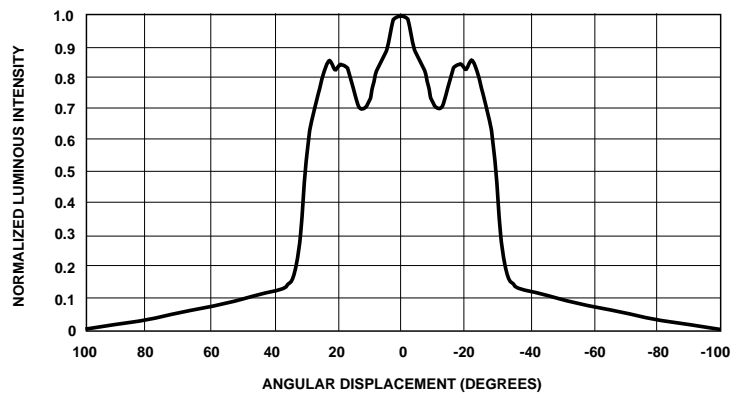

Figure 9a. Relative Intensity vs. Angle, HLMP-V500 Horizontal Axis.

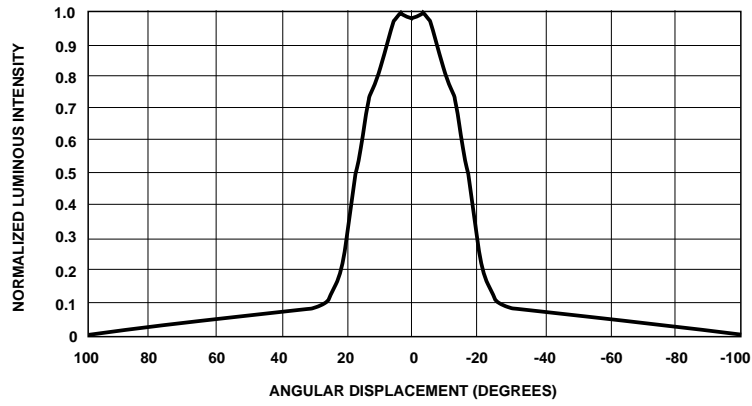

Figure 9b. Relative Intensity vs. Angle, HLMP-V500 Vertical Axis.