

T-1^{3/4} (5 mm) High Intensity LED Lamps

Technical Data

HLMP-331x Series
HLMP-341x Series
HLMP-351x Series

Features

- **High Intensity**
- **Choice of 3 Bright Colors**
 High Efficiency Red
 Yellow
 High Performance Green
- **Popular T-1^{3/4} Diameter Package**
- **Selected Minimum Intensities**
- **Narrow Viewing Angle**
- **General Purpose Leads**

- **Reliable and Rugged**
- **Available on Tape and Reel**

Description

This family of T-1^{3/4} nondiffused LED lamps is specially designed for applications requiring higher on-axis intensity than is achievable with a standard lamp. The light generated is focused to a narrow beam to achieve this effect.

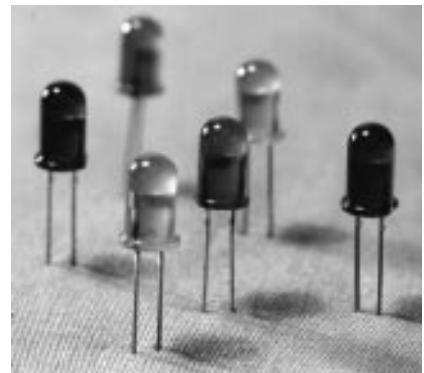

Selection Guide

| Color | Part Number | Luminous Intensity I _v (mcd) @ 10 mA | |
|--------|-----------------|--|-------|
| | | Min. | Max. |
| Red | HLMP-3315 | 13.8 | - |
| | HLMP-3317 | 22.00 | - |
| | HLMP-3316-I00xx | 22.0 | - |
| | HLMP-3316-IJ0xx | 22.0 | 70.4 |
| Yellow | HLMP-3415 | 9.2 | - |
| | HLMP-3416 | 14.7 | - |
| | HLMP-3416-G00xx | 14.7 | - |
| | HLMP-3416-IJ0xx | 37.6 | 120.2 |
| Green | HLMP-3517 | 6.7 | - |
| | HLMP-3519 | 10.6 | - |
| | HLMP-3519-F00xx | 10.6 | - |
| | HLMP-3519-IJ0xx | 43.6 | 139.6 |

Package Dimensions

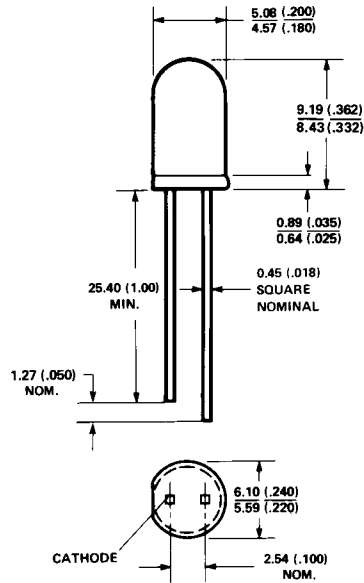

NOTES:
 1. ALL DIMENSIONS ARE IN MILLIMETRES (INCHES).
 2. AN EPOXY MENISCUS MAY EXTEND ABOUT 1mm (.040") DOWN THE LEADS.

Part Numbering System

HLMP - 3 x 1 x - x x x xx

Mechanical Option

00: Bulk
 01: Tape & Reel, Crimped Leads
 02: Tape & Reel, Straight Leads
 B1: Right Angle Housing, Uneven Leads
 B2: Right Angle Housing, Even Leads

Color Bin Options

0: Full Color Bin Distribution

Maximum Iv Bin Options

0: Open (no max. limit)
 Others: Please refer to the Iv Bin Table

Minimum Iv Bin Options

Please refer to the Iv Bin Table

Brightness Level

5, 7: Less Brightness
 6, 9: Higher Brightness

Color Options

3: GaP HER
 4: GaP Yellow
 5: GaP Green

Electrical Characteristics at $T_A = 25^\circ\text{C}$

| Symbol | Description | Device HLMP- | Min. | Typ. | Max. | Units | Test Conditions |
|--------------------------|---|----------------------|-------------|-------------------|-------------------|--------------------|--|
| I_V | Luminous Intensity | 3315 3316 | 13.8 22 | 40.0 60.0 | | mcd | $I_F = 10\text{ mA}$ (Figure 3) |
| | | 3415 3416 | 9.2 14.7 | 40.0 50.0 | | mcd | $I_F = 10\text{ mA}$ (Figure 8) |
| | | 3517 3519 | 6.7 10.6 | 50.0 70.0 | | mcd | $I_F = 10\text{ mA}$ (Figure 13) |
| $2\theta^{1/2}$ | Including Angle Between Half Luminous Intensity Points | 3315 3316 | | 35 35 | | Deg. | $I_F = 10\text{ mA}$ See Note 1 (Figure 6) |
| | | 3415 3416 | | 35 35 | | Deg. | $I_F = 10\text{ mA}$ See Note 1 (Figure 11) |
| | | 3517 3519 | | 24 24 | | Deg. | $I_F = 10\text{ mA}$ See Note 1 (Figure 16) |
| λ_{PEAK} | Peak Wavelength | 331X 341X 351X | | 635 583 565 | | nm | Measurement at Peak (Figure 1) |
| $\Delta\lambda_{1/2}$ | Spectral Line Halfwidth | 331X 341X 351X | | 40 36 28 | | nm | |
| λ_d | Dominant Wavelength | 331X 341X 351X | | 626 585 569 | | nm | See Note 2 (Figure 1) |
| τ_s | Speed of Response | 331X 341X 351X | | 90 90 500 | | ns | |
| C | Capacitance | 331X 341X 351X | | 11 15 18 | | pF | $V_F = 0$; $f = 1\text{ MHz}$ |
| $R\theta_{\text{J-PIN}}$ | Thermal Resistance | 331X 341X 351X | | 260 | | $^\circ\text{C/W}$ | Junction to Cathode Lead |
| V_F | Forward Voltage | 331X 341X 351X | | 1.9 2.0 2.1 | 2.4 2.4 2.7 | V | $I_F = 10\text{ mA}$ (Figure 2) $I_F = 10\text{ mA}$ (Figure 7) $I_F = 10\text{ mA}$ (Figure 12) |
| V_R | Reverse Breakdown Volt. | All | 5.0 | | | V | $I_R = 100\ \mu\text{A}$ |
| η_V | Luminous Efficacy | 331X 341X 351X | | 145 500 595 | | lumens Watt | See Note 3 |

Notes:

- $\theta_{1/2}$ is the off-axis angle at which the luminous intensity is half the axial luminous intensity.
- The dominant wavelength, λ_d , is derived from the CIE chromaticity diagram and represents the single wavelength which defines the color of the device.
- Radiant intensity, I_e , in watts/steradian, may be found from the equation $I_e = I_V/\eta_V$, where I_V is the luminous intensity in candelas and η_V is the luminous efficacy in lumens/watt.

Absolute Maximum Ratings at $T_A = 25^\circ\text{C}$

| Parameter | 331X Series | 341X Series | 351X Series | Units |
|--|------------------------------------|-------------|-------------|------------------|
| Peak Forward Current | 90 | 60 | 90 | mA |
| Average Forward Current ^[1] | 25 | 20 | 25 | mA |
| DC Current ^[2] | 30 | 20 | 30 | mA |
| Power Dissipation ^[3] | 135 | 85 | 135 | mW |
| Reverse Voltage ($I_R = 100 \mu\text{A}$) | 5 | 5 | 5 | V |
| Transient Forward Current ^[4] (10 μsec Pulse) | 500 | 500 | 500 | mA |
| LED Junction Temperature | 110 | 110 | 110 | $^\circ\text{C}$ |
| Operating Temperature Range | -55 to +100 | -55 to +100 | -20 to +100 | $^\circ\text{C}$ |
| Storage Temperature Range | | | -55 to +100 | |
| Lead Soldering Temperature [1.6 mm (0.063 in.) from body] | 260 $^\circ\text{C}$ for 5 seconds | | | |

Notes:

1. See Figure 5 (Red), 10 (Yellow), or 15 (Green) to establish pulsed operating conditions.
2. For Red and Green series derate linearly from 50 $^\circ\text{C}$ at 0.5 mA/ $^\circ\text{C}$. For Yellow series derate linearly from 50 $^\circ\text{C}$ at 0.2 mA/ $^\circ\text{C}$.
3. For Red and Green series derate power linearly from 25 $^\circ\text{C}$ at 1.8 mW/ $^\circ\text{C}$. For Yellow series derate power linearly from 50 $^\circ\text{C}$ at 1.6 mW/ $^\circ\text{C}$.
4. The transient peak current is the maximum non-recurring peak current that can be applied to the device without damaging the LED die and wirebond. It is not recommended that the device be operated at peak currents beyond the peak forward current listed in the Absolute Maximum Ratings.

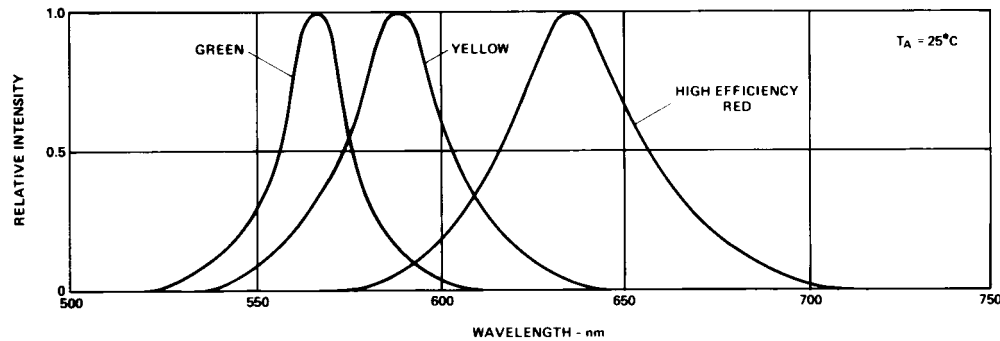

Figure 1. Relative Intensity vs. Wavelength.

High Efficiency Red HLMP-331X Series

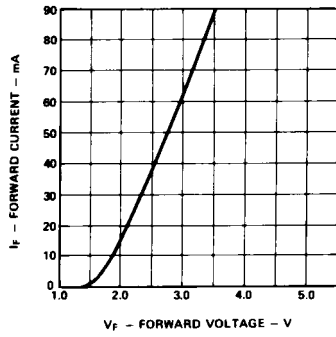

Figure 2. Forward Current vs. Forward Voltage Characteristics.

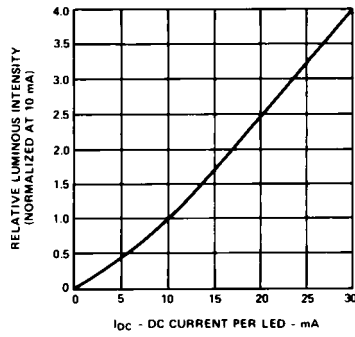

Figure 3. Relative Luminous Intensity vs. DC Forward Current.

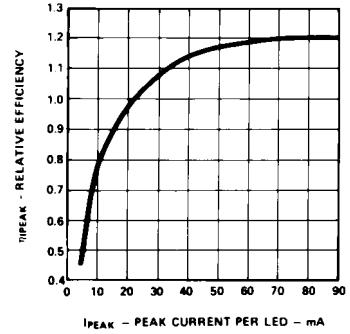

Figure 4. Relative Efficiency (Luminous Intensity per Unit Current) vs. Peak LED Current.

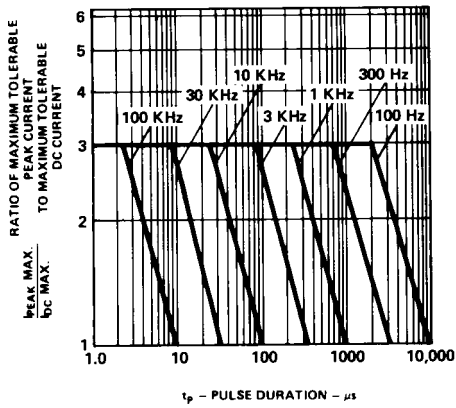

Figure 5. Maximum Tolerable Peak Current vs. Pulse Duration ($I_{DC\ MAX}$ as per MAX Ratings).

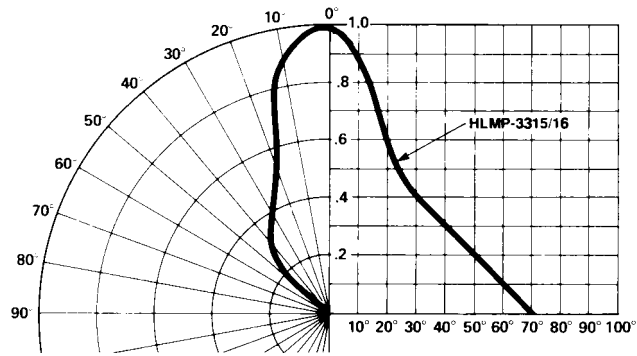

Figure 6. Relative Luminous Intensity vs. Angular Displacement.

Yellow HLMP-341X Series

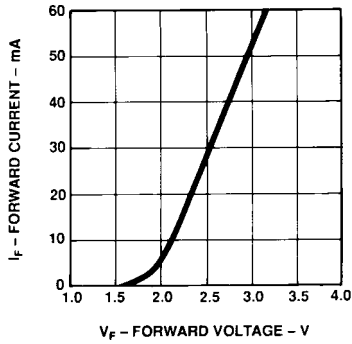

Figure 7. Forward Current vs. Forward Voltage Characteristics.

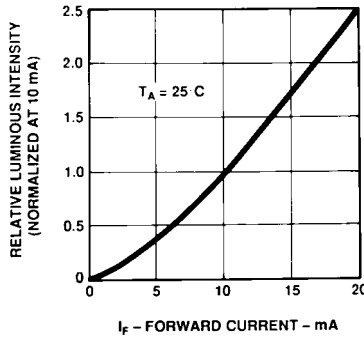

Figure 8. Relative Luminous Intensity vs. DC Forward Current.

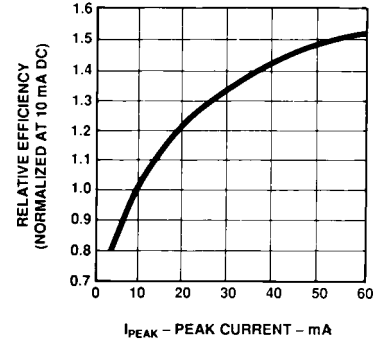

Figure 9. Relative Efficiency (Luminous Intensity per Unit Current) vs. Peak Current.

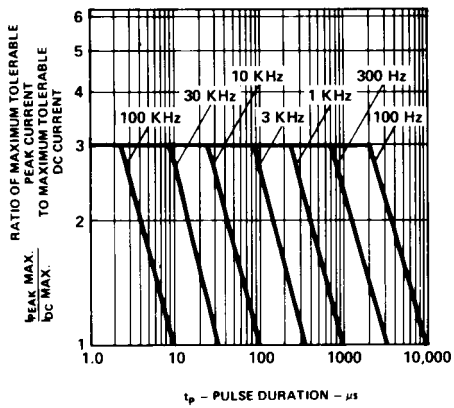

Figure 10. Maximum Tolerable Peak Current vs. Pulse Duration (I_{DC} MAX as per MAX Ratings).

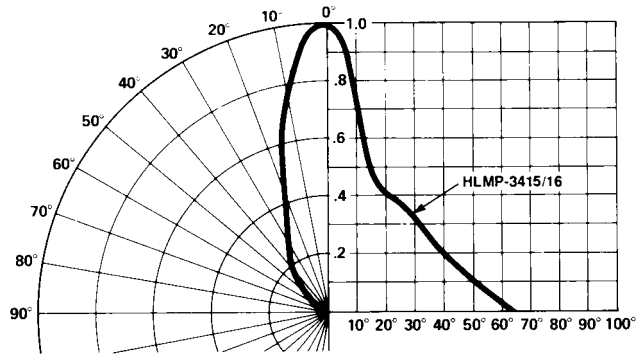

Figure 11. Relative Luminous Intensity vs. Angular Displacement.

Green HLMP-351X Series

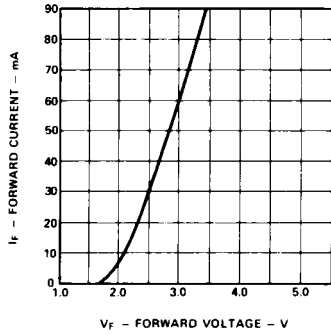

Figure 12. Forward Current vs. Forward Voltage Characteristics.

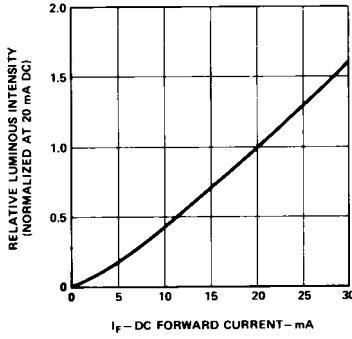

Figure 13. Relative Luminous Intensity vs. DC Forward Current.

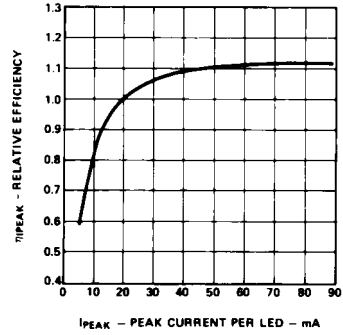

Figure 14. Relative Efficiency (Luminous Intensity per Unit Current) vs. Peak LED Current.

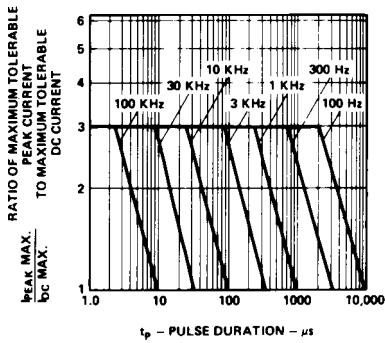

Figure 15. Maximum Tolerable Peak Current vs. Pulse Duration ($I_{DC\ MAX}$ as per MAX Ratings).

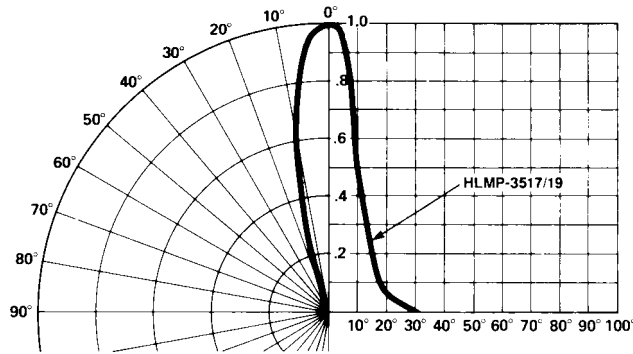

Figure 16. Relative Luminous Intensity vs. Angular Displacement. T-1^{3/4} Lamp.

Table 2. Intensity Bin Limit

| Color | Bin | Intensity Range (mcd) | |
|-------|---------|-----------------------|---------|
| | | Min. | Max. |
| Red | H | 15.5 | 24.8 |
| | I | 24.8 | 39.6 |
| | J | 39.6 | 63.4 |
| | K | 63.4 | 101.5 |
| | L | 101.5 | 162.4 |
| | M | 162.4 | 234.6 |
| | N | 234.6 | 340.0 |
| | O | 340.0 | 540.0 |
| | P | 540.0 | 850.0 |
| | Q | 850.0 | 1200.0 |
| | R | 1200.0 | 1700.0 |
| | S | 1700.0 | 2400.0 |
| | T | 2400.0 | 3400.0 |
| | U | 3400.0 | 4900.0 |
| | V | 4900.0 | 7100.0 |
| | W | 7100.0 | 10200.0 |
| X | 10200.0 | 14800.0 | |
| Y | 14800.0 | 21400.0 | |
| Z | 21400.0 | 30900.0 | |

Table 2. (Cont'd)

| Color | Bin | Intensity Range (mcd) | |
|--------|---------|-----------------------|---------|
| | | Min. | Max. |
| Yellow | G | 16.6 | 26.5 |
| | H | 26.5 | 42.3 |
| | I | 42.3 | 67.7 |
| | J | 67.7 | 108.2 |
| | K | 108.2 | 173.2 |
| | L | 173.2 | 250.0 |
| | M | 250.0 | 360.0 |
| | N | 360.0 | 510.0 |
| | O | 510.0 | 800.0 |
| | P | 800.0 | 1250.0 |
| | Q | 1250.0 | 1800.0 |
| | R | 1800.0 | 2900.0 |
| | S | 2900.0 | 4700.0 |
| | T | 4700.0 | 7200.0 |
| | U | 7200.0 | 11700.0 |
| | V | 11700.0 | 18000.0 |
| W | 18000.0 | 27000.0 | |

Table 2. (Cont'd)

| Color | Bin | Intensity Range (mcd) | |
|-------|---------|-----------------------|---------|
| | | Min. | Max. |
| Green | E | 7.6 | 12.0 |
| | F | 12.0 | 19.1 |
| | G | 19.1 | 30.7 |
| | H | 30.7 | 49.1 |
| | I | 49.1 | 78.5 |
| | J | 78.5 | 125.7 |
| | K | 125.7 | 201.1 |
| | L | 201.1 | 289.0 |
| | M | 289.0 | 417.0 |
| | N | 417.0 | 680.0 |
| | O | 680.0 | 1100.0 |
| | P | 1100.0 | 1800.0 |
| | Q | 1800.0 | 2700.0 |
| | R | 2700.0 | 4300.0 |
| | S | 4300.0 | 6800.0 |
| | T | 6800.0 | 10800.0 |
| U | 10800.0 | 16000.0 | |
| V | 16000.0 | 25000.0 | |
| W | 25000.0 | 40000.0 | |

Maximum tolerance for each bin limit is $\pm 18\%$.

Color Categories

| Color | Cat # | Lambda (nm) | |
|--------|-------|-------------|-------|
| | | Min. | Max. |
| Green | 6 | 561.5 | 564.5 |
| | 5 | 564.5 | 567.5 |
| | 4 | 567.5 | 570.5 |
| | 3 | 570.5 | 573.5 |
| | 2 | 573.5 | 576.5 |
| Yellow | 1 | 582.0 | 584.5 |
| | 3 | 584.5 | 587.0 |
| | 2 | 587.0 | 589.5 |
| | 4 | 589.5 | 592.0 |
| | 5 | 592.0 | 593.0 |

Tolerance for each bin limit is ± 0.5 nm.

Mechanical Option Matrix

| Mechanical Option Code | Definition |
|------------------------|--|
| 00 | Bulk Packaging, minimum increment 500 pcs/bag |
| 01 | Tape & Reel, crimped leads, minimum increment 1300 pcs/bag |
| 02 | Tape & Reel, straight leads, minimum increment 1300 pcs/bag |
| B1 | Right Angle Housing, uneven leads, minimum increment 500 pcs/bag |
| B2 | Right Angle Housing, even leads, minimum increment 500 pcs/bag |

Note:

All Categories are established for classification of products. Products may not be available in all categories. Please contact your local Agilent representative for further clarification/information.

