

# Low Noise, Cascadable Silicon Bipolar MMIC Amplifier

## Technical Data

INA-03184

### Features

- **Cascadable 50 Ω Gain Block**
- **Low Noise Figure:**  
2.6 dB Typical at 1.5 GHz
- **High Gain:**  
25 dB Typical at 1.5 GHz
- **3 dB Bandwidth:**  
DC to 2.5 GHz
- **Unconditionally Stable**  
( $k > 1$ )
- **Low Power Dissipation:**  
10 mA Bias
- **Low Cost Plastic Package**

### Description

The INA-03184 is a low-noise silicon bipolar Monolithic Microwave Integrated Circuit (MMIC)

feedback amplifier housed in a low cost surface mount plastic package. It is designed for narrow or wide bandwidth commercial and industrial applications that require high gain and low noise IF or RF amplification with minimum power consumption.

The INA series of MMICs is fabricated using HP's 10 GHz  $f_T$ , 25 GHz  $f_{MAX}$ , ISOSAT™-I silicon bipolar process which uses nitride self-alignment, submicrometer lithography, trench isolation, ion implantation, gold metallization and polyimide intermetal dielectric and scratch protection to achieve excellent performance, uniformity and reliability.

### 84 Plastic Package

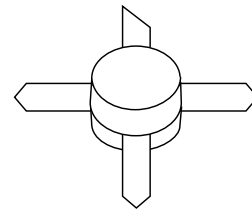

### Typical Biasing Configuration

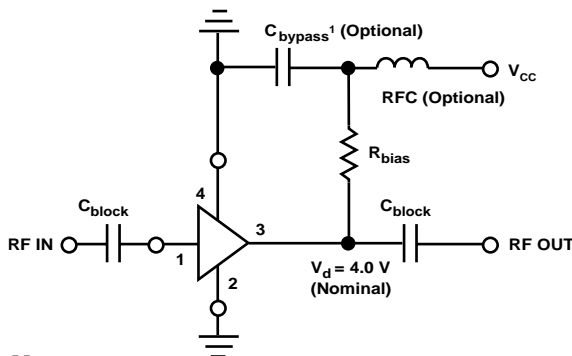

#### Note:

1. VSWR can be improved by bypassing a 100–120 Ω bias resistor directly to ground. See AN-S012: Low Noise Amplifiers.

## INA-03184 Absolute Maximum Ratings

| Parameter                        | Absolute Maximum <sup>[1]</sup> |
|----------------------------------|---------------------------------|
| Device Current                   | 25 mA                           |
| Power Dissipation <sup>[2]</sup> | 200 mW                          |
| RF Input Power                   | +13 dBm                         |
| Junction Temperature             | 150°C                           |
| Storage Temperature              | -65 to 150°C                    |

### Thermal Resistance:

$$\theta_{jc} = 100^{\circ}\text{C}/\text{W}$$

### Notes:

1. Permanent damage may occur if any of these limits are exceeded.
2. Derate at 10 mW/°C for  $T_C > 130^{\circ}\text{C}$ .

## INA-03184 Electrical Specifications<sup>[1]</sup>, $T_A = 25^{\circ}\text{C}$

| Symbol             | Parameters and Test Conditions: $I_d = 10 \text{ mA}$ , $Z_o = 50 \Omega$ | Units | Min. | Typ.                 | Max. |
|--------------------|---|-------|------|----------------------|------|
| $G_P$              | Power Gain ( $ S_{21} ^2$ )<br>$f = 1.5 \text{ GHz}$                      | dB    | 23.0 | 25.0                 |      |
| $\Delta G_P$       | Gain Flatness<br>$f = 0.1 \text{ to } 2.0 \text{ GHz}$                    | dB    |      | $\pm 0.8$            |      |
| $f_3 \text{ dB}$   | 3 dB Bandwidth <sup>[2]</sup>   | GHz   |      | 2.5                  |      |
| ISO                | Reverse Isolation ( $ S_{12} ^2$ )<br>$f = 1.5 \text{ GHz}$               | dB    |      | 35                   |      |
| VSWR               | Input VSWR<br>$f = 0.01 \text{ to } 2.0 \text{ GHz}$                      |       |      | 2.0:1                |      |
|                    | Output VSWR<br>$f = 0.01 \text{ to } 2.0 \text{ GHz}$                     |       |      | 3.0:1 <sup>[3]</sup> |      |
| NF                 | 50 $\Omega$ Noise Figure<br>$f = 1.5 \text{ GHz}$                         | dB    |      | 2.6                  |      |
| $P_{1 \text{ dB}}$ | Output Power at 1 dB Gain Compression<br>$f = 1.5 \text{ GHz}$            | dBm   |      | -2.0                 |      |
| $IP_3$             | Third Order Intercept Point<br>$f = 1.5 \text{ GHz}$                      | dBm   |      | 7                    |      |
| $t_D$              | Group Delay<br>$f = 1.5 \text{ GHz}$                                      | psec  |      | 210                  |      |
| $V_d$              | Device Voltage  | V     | 3.0  | 4.0                  | 5.0  |
| $dV/dT$            | Device Voltage Temperature Coefficient                                    | mV/°C |      | +4                   |      |

### Notes:

1. The recommended operating current range for this device is 8 to 18 mA. Typical performance as a function of current is on the following page.
2. Referenced from 10 MHz Gain ( $G_P$ ).
3. VSWR can be improved by bypassing a 100–200  $\Omega$  bias resistor directly to ground. See AN-S012: MagIC Low Noise Amplifiers.

## INA-03184 Part Number Ordering Information

| Part Number   | No. of Devices | Container      |
|---------------|----------------|----------------|
| INA-03184-TR1 | 1000           | 7" Reel        |
| INA-03184-BLK | 100            | Antistatic Bag |

For more information, see "Tape and Reel Packaging for Semiconductor Devices".

## INA-03184 Typical Scattering Parameters ( $Z_0 = 50 \Omega$ , $T_A = 25^\circ\text{C}$ , $I_d = 10 \text{ mA}$ )

| Freq.<br>GHz | $S_{11}$ |     | $S_{21}$ |       |      | $S_{12}$ |      |     | $S_{22}$ |     | k    |
|--------------|----------|-----|----------|-------|------|----------|------|-----|----------|-----|------|
|              | Mag      | Ang | dB       | Mag   | Ang  | dB       | Mag  | Ang | Mag      | Ang |      |
| 0.05         | .32      | 179 | 25.6     | 19.14 | -3   | -37.1    | .014 | 3   | .55      | 0   | 1.48 |
| 0.10         | .32      | 176 | 25.6     | 19.05 | -7   | -37.1    | .014 | 4   | .57      | -3  | 1.45 |
| 0.20         | .32      | 172 | 25.6     | 19.05 | -14  | -37.1    | .014 | 6   | .55      | -5  | 1.48 |
| 0.40         | .32      | 165 | 25       | 18.78 | -29  | -37.1    | .014 | 10  | .53      | -11 | 1.53 |
| 0.60         | .32      | 158 | 25.4     | 18.71 | -43  | -36.5    | .015 | 11  | .51      | -14 | 1.49 |
| 0.80         | .32      | 151 | 25.4     | 18.53 | -57  | -36.5    | .015 | 13  | .51      | -17 | 1.50 |
| 1.00         | .32      | 144 | 25.2     | 18.18 | -72  | -35.9    | .016 | 21  | .50      | -20 | 1.46 |
| 1.20         | .30      | 135 | 25.2     | 18.27 | -86  | -35.9    | .016 | 25  | .50      | -23 | 1.46 |
| 1.40         | .31      | 126 | 25.2     | 18.10 | -102 | -35.4    | .017 | 30  | .49      | -29 | 1.42 |
| 1.60         | .30      | 117 | 25.1     | 17.92 | -117 | -34.9    | .018 | 38  | .48      | -34 | 1.38 |
| 1.80         | .26      | 102 | 24.9     | 17.49 | -135 | -34.4    | .019 | 44  | .45      | -41 | 1.39 |
| 2.00         | .22      | 92  | 24.4     | 16.62 | -153 | -34.0    | .020 | 49  | .40      | -50 | 1.44 |
| 2.50         | .09      | 91  | 22.2     | 12.88 | 168  | -33.6    | .021 | 57  | .26      | -48 | 1.87 |
| 3.00         | .14      | 160 | 18.9     | 8.79  | 134  | -32.8    | .023 | 65  | .22      | -33 | 2.40 |
| 3.50         | .24      | 151 | 15.4     | 5.92  | 108  | -32.0    | .025 | 69  | .26      | -33 | 3.01 |
| 4.00         | .29      | 139 | 12.4     | 4.18  | 87   | -30.8    | .029 | 81  | .28      | -43 | 3.52 |

### Note:

- S-parameters are de-embedded from 70 mil package measured data using the package model found in the DEVICE MODELS section.

## INA-03184 Typical Performance, $T_A = 25^\circ\text{C}$

(unless otherwise noted)

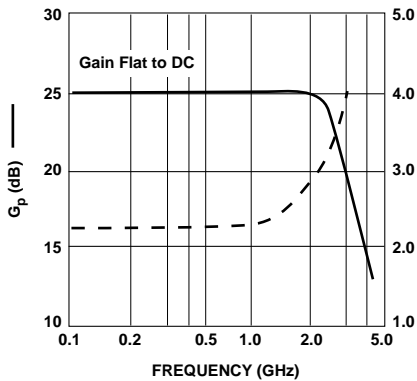

Figure 1. Typical Gain and Noise Figure vs. Frequency,  $T_A = 25^\circ\text{C}$ ,  $I_d = 10 \text{ mA}$ .

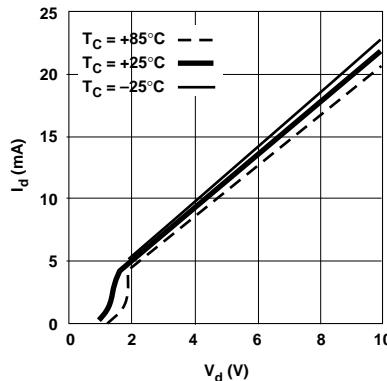

Figure 2. Device Current vs. Voltage.

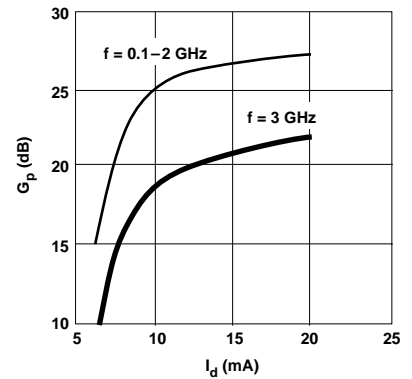

Figure 3. Power Gain vs. Current.

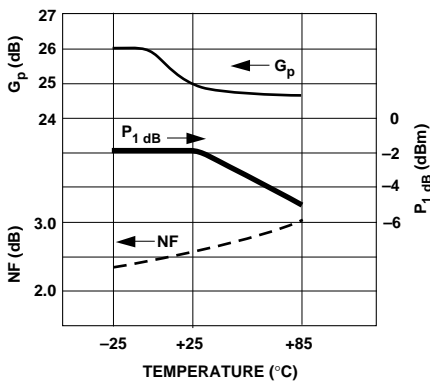

Figure 4. Output Power at 1 dB Gain Compression, NF and Power Gain vs. Case Temperature,  $f = 1.5 \text{ GHz}$ ,  $I_d = 10 \text{ mA}$ .

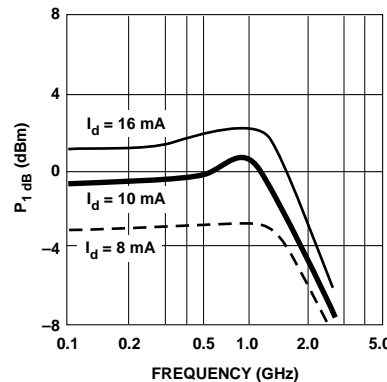

Figure 5. Output Power at 1 dB Gain Compression vs. Frequency.

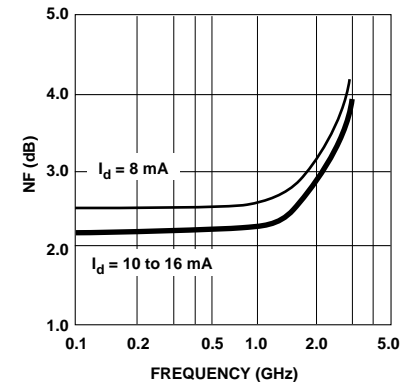

Figure 6. Noise Figure vs. Frequency.

## 84 Plastic Package Dimensions

