

# International IOR Rectifier

16CTU04  
16CTU04S  
16CTU04-1

## Ultrafast Rectifier

### Features

- Ultrafast Recovery Time
- Low Forward Voltage Drop
- Low Leakage Current
- 175°C Operating Junction Temperature

$t_{rr} = 60ns$   
 $I_{F(AV)} = 16Amp$   
 $V_R = 400V$




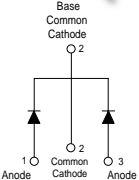
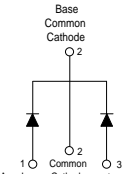
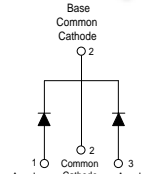
### Description/ Applications

International Rectifier's FRED.. series are the state of the art Ultra fast recovery rectifiers specifically designed with optimized performance of forward voltage drop and ultra fast recovery time. The planar structure and the platinum doped life time control, guarantee the best overall performance, ruggedness and reliability characteristics. These devices are intended for use in the output rectification stage of SMPS, UPS, DC-DC converters as well as free-wheeling diode in low voltage inverters and chopper motor drives. Their extremely optimized stored charge and low recovery current minimize the switching losses and reduce over dissipation in the switching element and snubbers.

### Absolute Maximum Ratings

Parameters	Max	Units
$V_{RRM}$ Peak Repetitive Peak Reverse Voltage	400	V
$I_{F(AV)}$ Average Rectified Forward Current	Per Leg 8	A
	Total Device, (Rated $V_R$ ), $T_C = 155^\circ C$ Total Device 16	
$I_{FSM}$ Non Repetitive Peak Surge Current, $T_C = 25^\circ C$	100	
$I_{FRM}$ Peak Repetitive Forward Current (Rated $V_R$ , Square wave, 20KHz), $T_C = 155^\circ C$	16	
$T_J, T_{STG}$ Operating Junction and Storage Temperatures	- 65 to 175	$^\circ C$

### Case Styles

16CTU04	16CTU04S	16CTU04-1
		
<p>Base Common Cathode O 2</p>  <p>1 O Anode O 2 Common Cathode O 3 Anode</p> <p>TO-220AB</p>	<p>Base Common Cathode O 2</p>  <p>1 O Anode O 2 Common Cathode O 3 Anode</p> <p>D<sup>2</sup>PAK</p>	<p>Base Common Cathode O 2</p>  <p>1 O Anode O 2 Common Cathode O 3 Anode</p> <p>TO-262</p>

**Electrical Characteristics @ T<sub>J</sub> = 25°C, Per Leg (unless otherwise specified)**

Parameters	Min	Typ	Max	Units	Test Conditions
V <sub>BR</sub> , V <sub>r</sub> Breakdown Voltage, Blocking Voltage	400	-	-	V	I <sub>R</sub> = 100μA
V <sub>F</sub> Forward Voltage	-	1.19	1.3	V	I <sub>F</sub> = 8A
	-	0.94	1.0	V	I <sub>F</sub> = 8A, T <sub>J</sub> = 150°C
I <sub>R</sub> Reverse Leakage Current	-	0.2	10	μA	V <sub>R</sub> = V <sub>R</sub> Rated
	-	20	500	μA	T <sub>J</sub> = 150°C, V <sub>R</sub> = V <sub>R</sub> Rated
C <sub>T</sub> Junction Capacitance	-	14	-	pF	V <sub>R</sub> = 400V
L <sub>S</sub> Series Inductance	-	8.0	-	nH	Measured lead to lead 5mm from package body

**Dynamic Recovery Characteristics @ T<sub>J</sub> = 25°C, Per Leg (unless otherwise specified)**

Parameters	Min	Typ	Max	Units	Test Conditions	
t <sub>rr</sub> Reverse Recovery Time	-	35	60	ns	I <sub>F</sub> = 1.0A, di <sub>F</sub> /dt = 50A/μA, V <sub>R</sub> = 30V	
	-	43	-		T <sub>J</sub> = 25°C	I <sub>F</sub> = 8A V <sub>R</sub> = 200V di <sub>F</sub> /dt = 200A/μs
	-	67	-		T <sub>J</sub> = 125°C	
I <sub>RRM</sub> Peak Recovery Current	-	2.8	-	A	T <sub>J</sub> = 25°C	
	-	6.3	-		T <sub>J</sub> = 125°C	
Q <sub>rr</sub> Reverse Recovery Charge	-	60	-	nC	T <sub>J</sub> = 25°C	
	-	210	-		T <sub>J</sub> = 125°C	

**Thermal - Mechanical Characteristics**

Parameters	Min	Typ	Max	Units
T <sub>J</sub> Max. Junction Temperature Range	-	-	175	°C
T <sub>Stg</sub> max. Storage Temperature Range	- 65	-	175	
R <sub>thJC</sub> Thermal Resistance, Junction to Case	-	1.8	2	°C/W
R <sub>thJA</sub> ① Thermal Resistance, Junction to Ambient	-	-	50	
R <sub>thCS</sub> ② Thermal Resistance, Case to Heatsink	-	0.5	-	
Wt Weight	-	2.0	-	g
	-	0.07	-	(oz)
Mounting Torque	6.0	-	12	Kg-cm
	5.0	-	10	lbf.in

① Typical Socket Mount

② Mounting Surface, Flat, Smooth and Greased

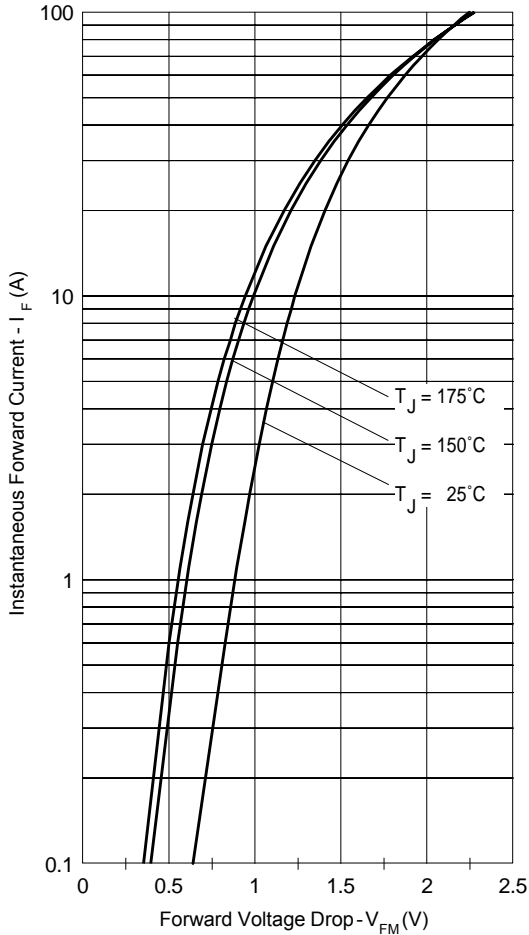


Fig. 1 - Typical Forward Voltage Drop Characteristics

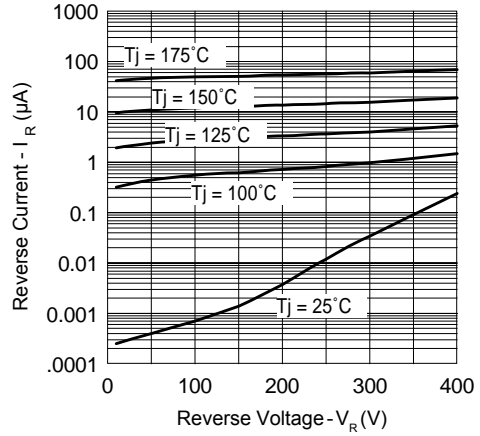


Fig. 2 - Typical Values Of Reverse Current Vs. Reverse Voltage

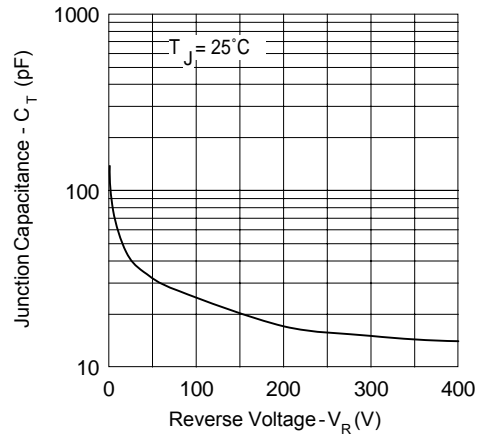


Fig. 3 - Typical Junction Capacitance Vs. Reverse Voltage

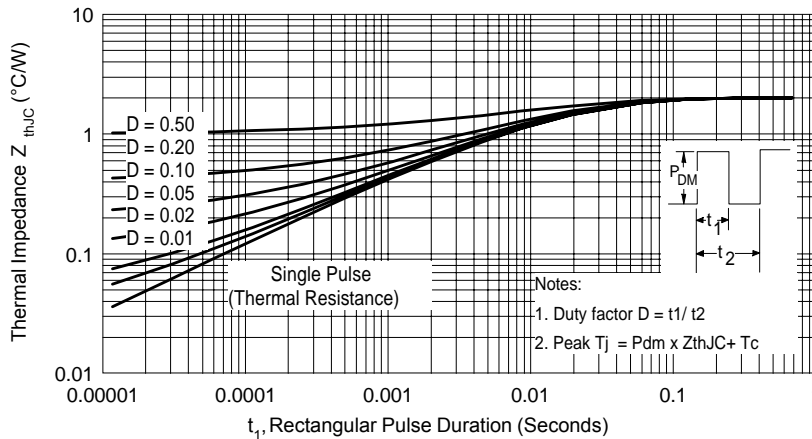
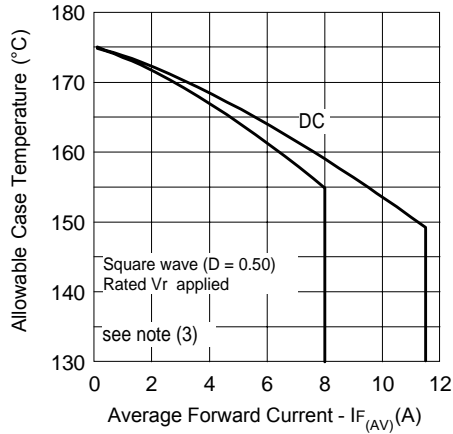
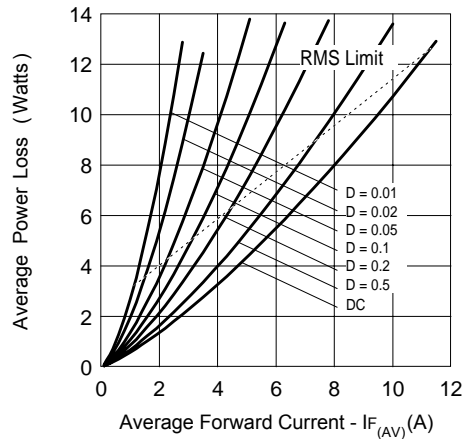


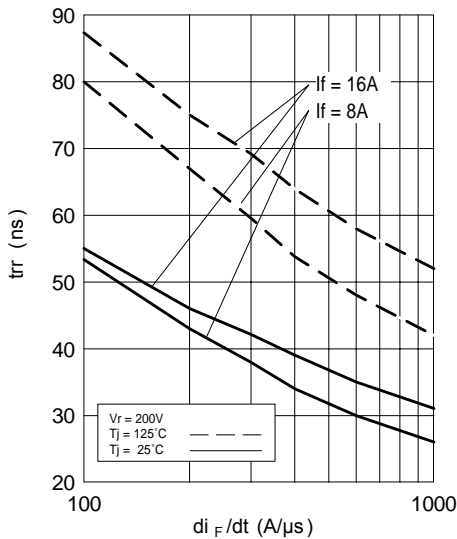
Fig. 4 - Max. Thermal Impedance  $Z_{thJC}$  Characteristics



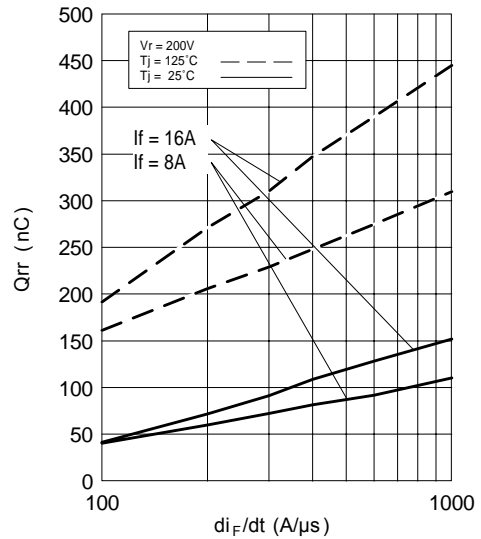
**Fig. 5 - Max. Allowable Case Temperature Vs. Average Forward Current**



**Fig. 6 - Forward Power Loss Characteristics**

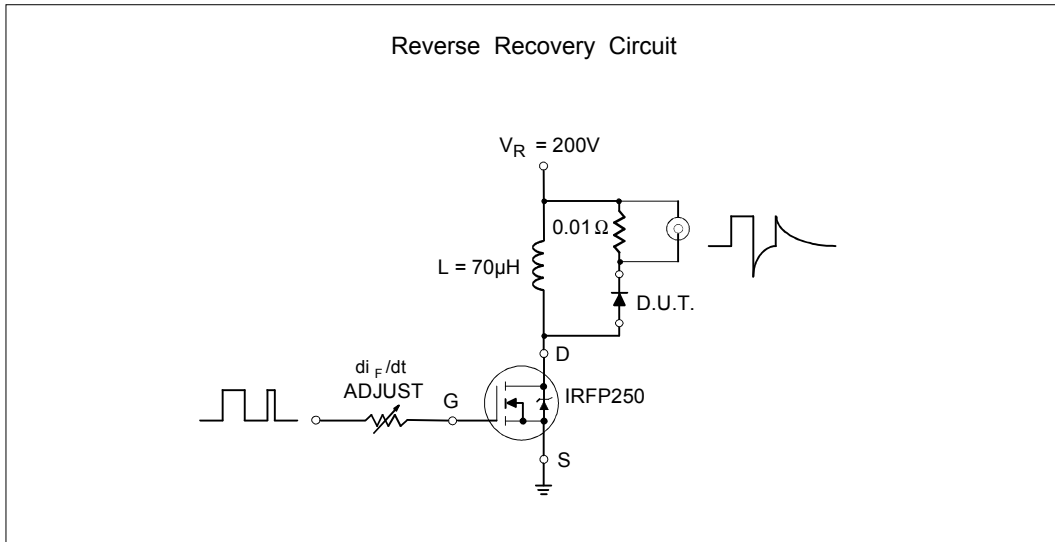


**Fig. 7 - Typical Reverse Recovery vs. di\_F/dt**

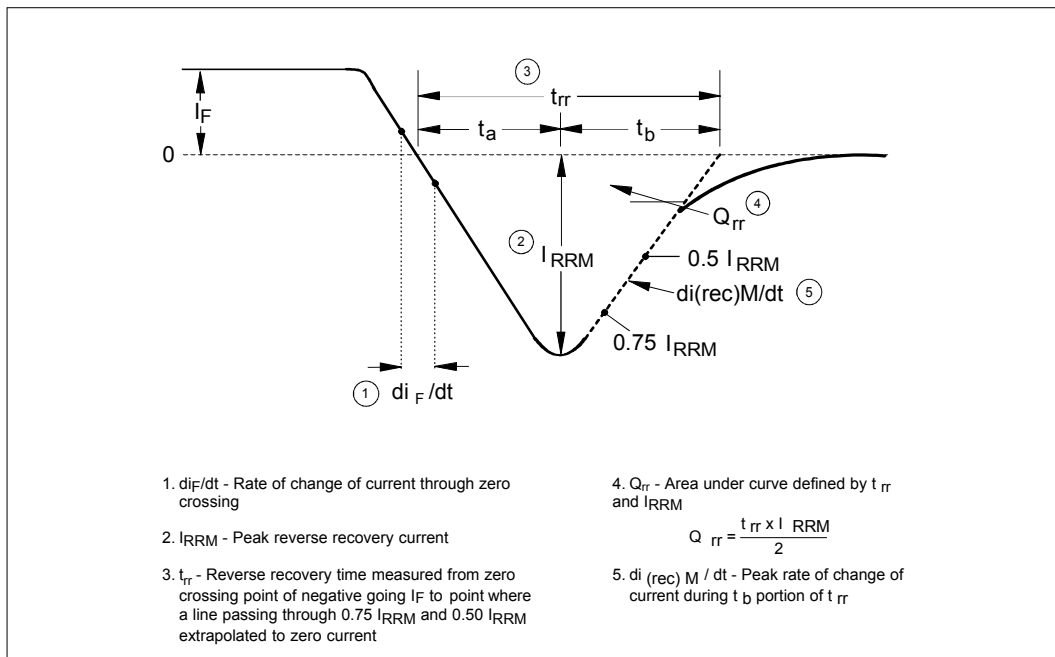


**Fig. 8 - Typical Stored Charge vs. di\_F/dt**

(3) Formula used:  $T_c = T_j - (P_d + P_{d_{REV}}) \times R_{thJC}$ ;  
 $P_d = \text{Forward Power Loss} = I_{F(AV)} \times V_{FM} @ (I_{F(AV)} / D)$  (see Fig. 6);  
 $P_{d_{REV}} = \text{Inverse Power Loss} = V_{R1} \times I_R (1 - D)$ ;  $I_R @ V_{R1} = \text{rated } V_R$

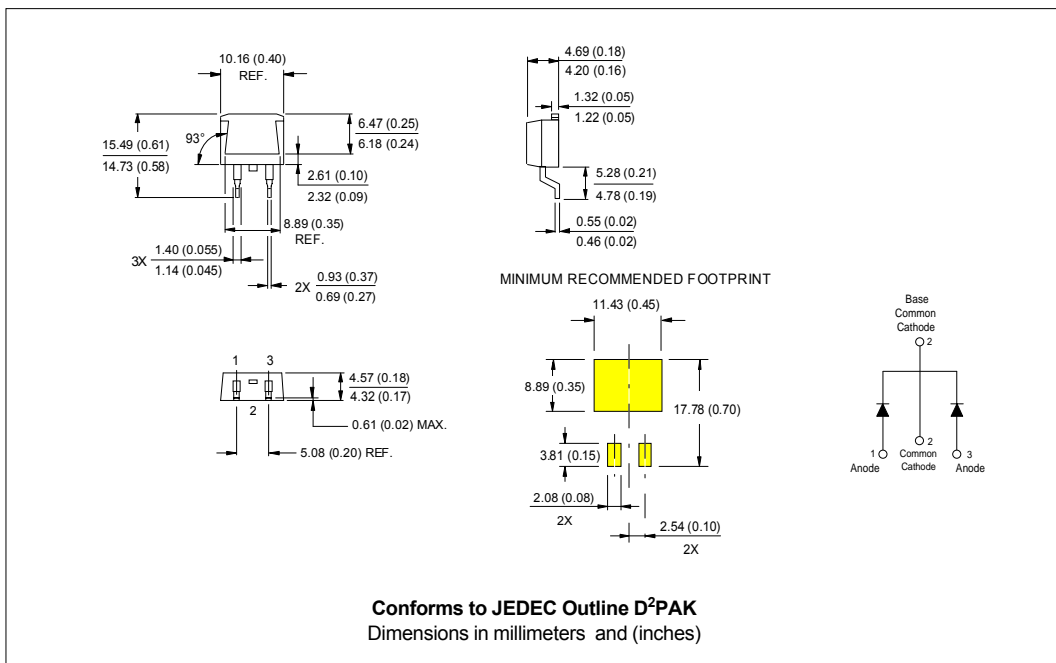
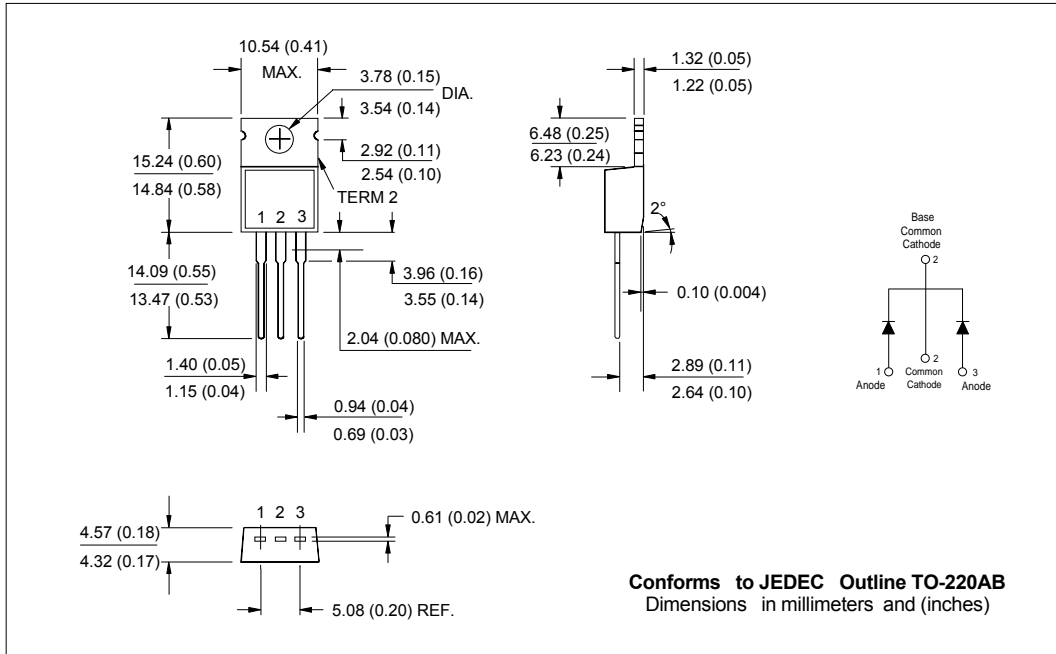


**Fig. 9- Reverse Recovery Parameter Test Circuit**

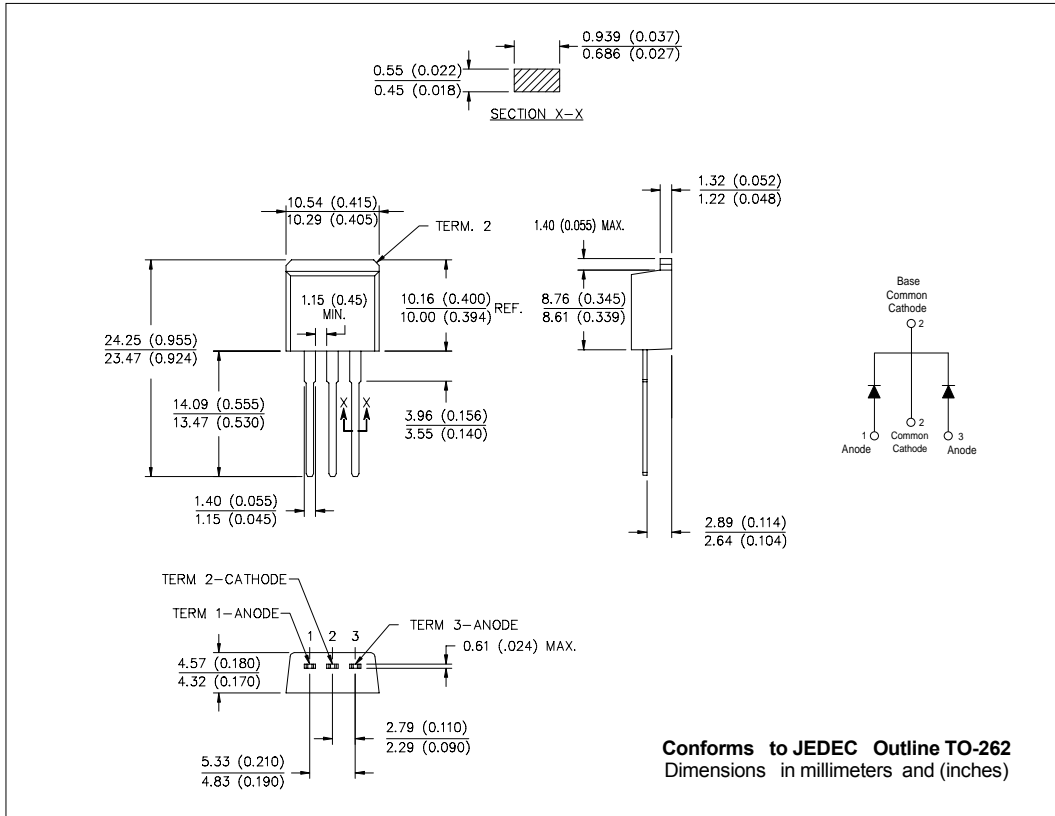


**Fig. 10 - Reverse Recovery Waveform and Definitions**

Outline Table



Outline Table



Ordering Information Table

Device Code					
16	C	T	U	04	- 1
①	②	③	④	⑤	⑥
1	- Current Rating (16 = 16A)				
2	- Common Cathode				
3	- TO-220/ D <sup>2</sup> Pak				
4	- Ultrafast Recovery				
5	- Voltage Rating (04 = 400V)				
6	- Suffix for SMD type -1: TO-262 Option S: TO-220 SMD (D <sup>2</sup> Pak)				

16CTU04, 16CTU04S, 16CTU04-1

Bulletin PD-20752 rev. A 11/01

International  
**IR** Rectifier

Data and specifications subject to change without notice.  
This product has been designed and qualified for Industrial Level.  
Qualification Standards can be found on IR's Web site.

International  
**IR** Rectifier

**IR WORLD HEADQUARTERS:** 233 Kansas St., El Segundo, California 90245, USA Tel: (310) 252-7105  
TAC Fax: (310) 252-7309  
Visit us at [www.irf.com](http://www.irf.com) for sales contact information. 11/01