



# IRF7343

HEXFET® Power MOSFET

- Generation V Technology
- Ultra Low On-Resistance
- Dual N and P Channel MOSFET
- Surface Mount
- Fully Avalanche Rated

## Description

Fifth Generation HEXFETs from International Rectifier utilize advanced processing techniques to achieve extremely low on-resistance per silicon area. This benefit, combined with the fast switching speed and ruggedized device design that HEXFET Power MOSFETs are well known for, provides the designer with an extremely efficient and reliable device for use in a wide variety of applications.

The SO-8 has been modified through a customized leadframe for enhanced thermal characteristics and multiple-die capability making it ideal in a variety of power applications. With these improvements, multiple devices can be used in an application with dramatically reduced board space. The package is designed for vapor phase, infra red, or wave soldering techniques.

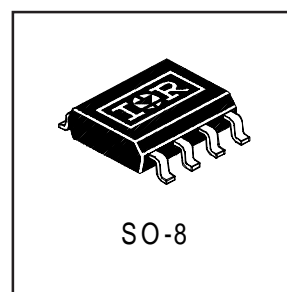
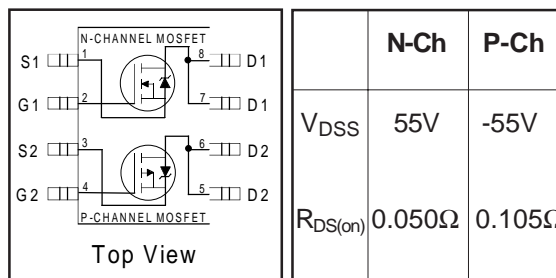

## Absolute Maximum Ratings

Parameter	Description	Max.		Units
		N-Channel	P-Channel	
$V_{DS}$	Drain-Source Voltage	55	-55	V
$I_D @ T_A = 25^\circ C$	Continuous Drain Current, $V_{GS} @ 10V$	4.7	-3.4	A
$I_D @ T_A = 70^\circ C$	Continuous Drain Current, $V_{GS} @ 10V$	3.8	-2.7	
$I_{DM}$	Pulsed Drain Current ①	38	-27	
$P_D @ T_A = 25^\circ C$	Maximum Power Dissipation ⑤	2.0		W
$P_D @ T_A = 70^\circ C$	Maximum Power Dissipation ⑤	1.3		W
$E_{AS}$	Single Pulse Avalanche Energy ③	72	114	mJ
$I_{AR}$	Avalanche Current	4.7	-3.4	A
$E_{AR}$	Repetitive Avalanche Energy	0.20		mJ
$V_{GS}$	Gate-to-Source Voltage	$\pm 20$		V
dv/dt	Peak Diode Recovery dv/dt ②	5.0	-5.0	V/ns
$T_J, T_{STG}$	Junction and Storage Temperature Range	-55 to + 150		°C

## Thermal Resistance

Parameter	Description	Typ.	Max.	Units
$R_{\theta JA}$	Maximum Junction-to-Ambient ⑤	—	62.5	°C/W

## Electrical Characteristics @ T<sub>J</sub> = 25°C (unless otherwise specified)

Parameter	Description		Min.	Typ.	Max.	Units	Conditions
V <sub>(BR)DSS</sub>	Drain-to-Source Breakdown Voltage	N-Ch	55	—	—	V	V <sub>GS</sub> = 0V, I <sub>D</sub> = 250μA
		P-Ch	-55	—	—		V <sub>GS</sub> = 0V, I <sub>D</sub> = -250μA
ΔV <sub>(BR)DSS</sub> /ΔT <sub>J</sub>	Breakdown Voltage Temp. Coefficient	N-Ch	—	0.059	—	V/°C	Reference to 25°C, I <sub>D</sub> = 1mA
		P-Ch	—	0.054	—		Reference to 25°C, I <sub>D</sub> = -1mA
R <sub>DS(ON)</sub>	Static Drain-to-Source On-Resistance	N-Ch	—	0.043	0.050	Ω	V <sub>GS</sub> = 10V, I <sub>D</sub> = 4.7A ④
			—	0.056	0.065		V <sub>GS</sub> = 4.5V, I <sub>D</sub> = 3.8A ④
		P-Ch	—	0.095	0.105		V <sub>GS</sub> = -10V, I <sub>D</sub> = -3.4A ④
			—	0.150	0.170		V <sub>GS</sub> = -4.5V, I <sub>D</sub> = -2.7A ④
V <sub>GS(th)</sub>	Gate Threshold Voltage	N-Ch	1.0	—	—	V	V <sub>DS</sub> = V <sub>GS</sub> , I <sub>D</sub> = 250μA
		P-Ch	-1.0	—	—		V <sub>DS</sub> = V <sub>GS</sub> , I <sub>D</sub> = -250μA
g <sub>fs</sub>	Forward Transconductance	N-Ch	7.9	—	—	S	V <sub>DS</sub> = 10V, I <sub>D</sub> = 4.5A ④
		P-Ch	3.3	—	—		V <sub>DS</sub> = -10V, I <sub>D</sub> = -3.1A ④
I <sub>DSS</sub>	Drain-to-Source Leakage Current	N-Ch	—	—	2.0	μA	V <sub>DS</sub> = 55V, V <sub>GS</sub> = 0V
		P-Ch	—	—	-2.0		V <sub>DS</sub> = -55V, V <sub>GS</sub> = 0V
		N-Ch	—	—	25		V <sub>DS</sub> = 55V, V <sub>GS</sub> = 0V, T <sub>J</sub> = 55°C
		P-Ch	—	—	-25		V <sub>DS</sub> = -55V, V <sub>GS</sub> = 0V, T <sub>J</sub> = 55°C
I <sub>GSS</sub>	Gate-to-Source Forward Leakage	N-P	—	—	±100	nA	V <sub>GS</sub> = ±20V
Q <sub>g</sub>	Total Gate Charge	N-Ch	—	24	36	nC	N-Channel
		P-Ch	—	26	38		I <sub>D</sub> = 4.5A, V <sub>DS</sub> = 44V, V <sub>GS</sub> = 10V ④
Q <sub>gs</sub>	Gate-to-Source Charge	N-Ch	—	2.3	3.4		
		P-Ch	—	3.0	4.5		
Q <sub>gd</sub>	Gate-to-Drain ("Miller") Charge	N-Ch	—	7.0	10		P-Channel
		P-Ch	—	8.4	13		I <sub>D</sub> = -3.1A, V <sub>DS</sub> = -44V, V <sub>GS</sub> = -10V ④
t <sub>d(on)</sub>	Turn-On Delay Time	N-Ch	—	8.3	12	ns	N-Channel
		P-Ch	—	14	22		V <sub>DD</sub> = 28V, I <sub>D</sub> = 1.0A, R <sub>G</sub> = 6.0Ω, R <sub>D</sub> = 16Ω ④
t <sub>r</sub>	Rise Time	N-Ch	—	3.2	4.8		
		P-Ch	—	10	15		
t <sub>d(off)</sub>	Turn-Off Delay Time	N-Ch	—	32	48		P-Channel
		P-Ch	—	43	64		V <sub>DD</sub> = -28V, I <sub>D</sub> = -1.0A, R <sub>G</sub> = 6.0Ω, R <sub>D</sub> = 16Ω ④
t <sub>f</sub>	Fall Time	N-Ch	—	13	20		
		P-Ch	—	22	32		
C <sub>iss</sub>	Input Capacitance	N-Ch	—	740	—	pF	N-Channel
		P-Ch	—	690	—		V <sub>GS</sub> = 0V, V <sub>DS</sub> = 25V, f = 1.0MHz
C <sub>oss</sub>	Output Capacitance	N-Ch	—	190	—		P-Channel
		P-Ch	—	210	—		V <sub>GS</sub> = 0V, V <sub>DS</sub> = -25V, f = 1.0MHz
C <sub>rss</sub>	Reverse Transfer Capacitance	N-Ch	—	71	—		
		P-Ch	—	86	—		

## Source-Drain Ratings and Characteristics

Parameter	Description		Min.	Typ.	Max.	Units	Conditions
I <sub>S</sub>	Continuous Source Current (Body Diode)	N-Ch	—	—	2.0	A	
		P-Ch	—	—	-2.0		
I <sub>SM</sub>	Pulsed Source Current (Body Diode) ①	N-Ch	—	—	38		
		P-Ch	—	—	-27		
V <sub>SD</sub>	Diode Forward Voltage	N-Ch	—	0.70	1.2	V	T <sub>J</sub> = 25°C, I <sub>S</sub> = 2.0A, V <sub>GS</sub> = 0V ③
		P-Ch	—	-0.80	-1.2		T <sub>J</sub> = 25°C, I <sub>S</sub> = -2.0A, V <sub>GS</sub> = 0V ③
t <sub>rr</sub>	Reverse Recovery Time	N-Ch	—	60	90	ns	N-Channel
		P-Ch	—	54	80		T <sub>J</sub> = 25°C, I <sub>F</sub> = 2.0A, di/dt = 100A/μs ④
Q <sub>rr</sub>	Reverse Recovery Charge	N-Ch	—	120	170	nC	P-Channel
		P-Ch	—	85	130		T <sub>J</sub> = 25°C, I <sub>F</sub> = -2.0A, di/dt = 100A/μs ④

### Notes:

- ① Repetitive rating; pulse width limited by max. junction temperature. ( See fig. 22 )
- ② N-Channel I<sub>SD</sub> ≤ 4.7A, di/dt ≤ 220A/μs, V<sub>DD</sub> ≤ V<sub>(BR)DSS</sub>, T<sub>J</sub> ≤ 150°C  
P-Channel I<sub>SD</sub> ≤ -3.4A, di/dt ≤ -150A/μs, V<sub>DD</sub> ≤ V<sub>(BR)DSS</sub>, T<sub>J</sub> ≤ 150°C
- ③ N-Channel Starting T<sub>J</sub> = 25°C, L = 6.5mH R<sub>G</sub> = 25Ω, I<sub>AS</sub> = 4.7A.  
P-Channel Starting T<sub>J</sub> = 25°C, L = 20mH R<sub>G</sub> = 25Ω, I<sub>AS</sub> = -3.4A.
- ④ Pulse width ≤ 300μs; duty cycle ≤ 2%.
- ⑤ Surface mounted on FR-4 board, t ≤ 10sec.

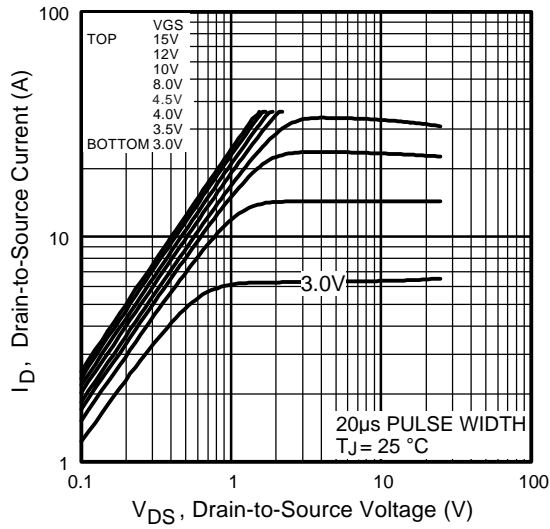

Fig 1. Typical Output Characteristics

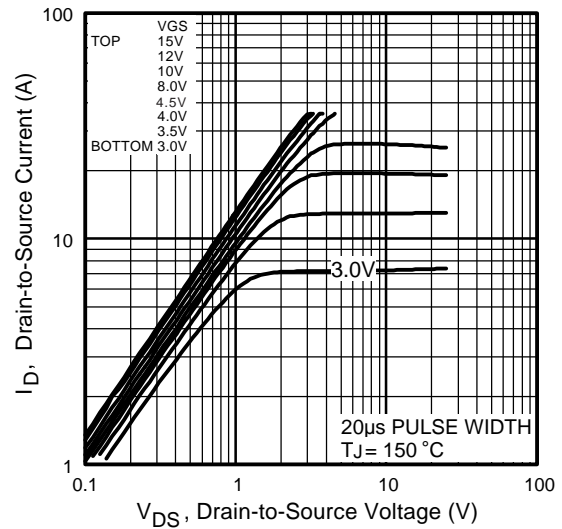

Fig 2. Typical Output Characteristics

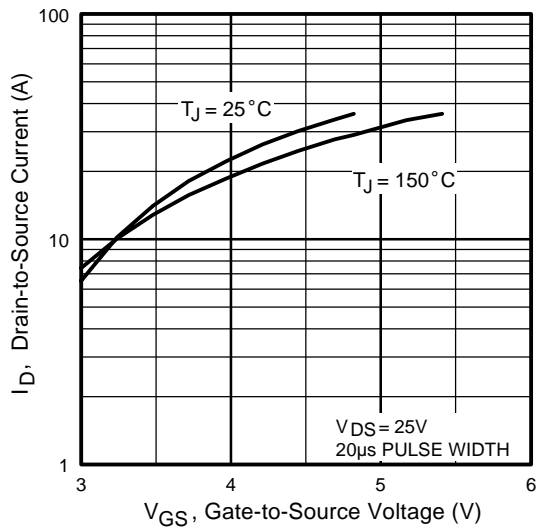

Fig 3. Typical Transfer Characteristics

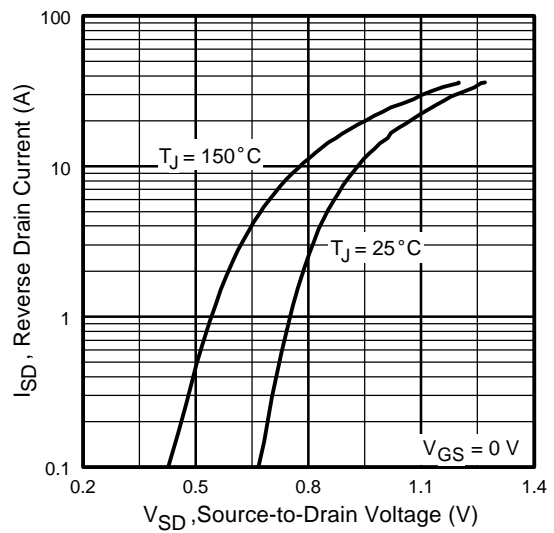
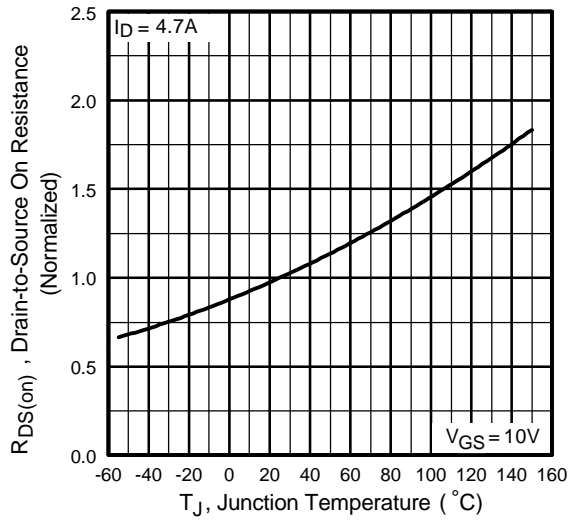
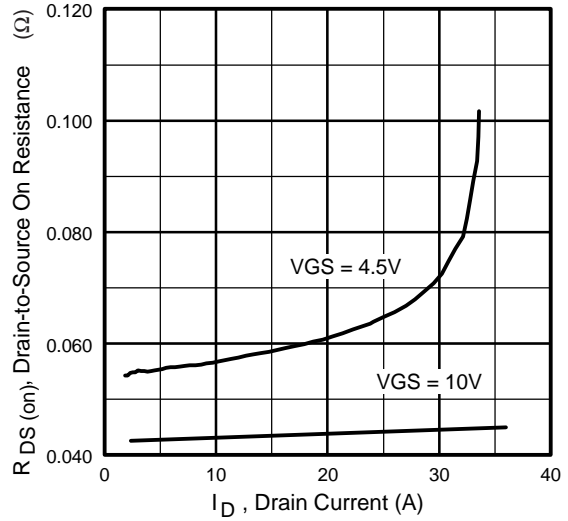

Fig 4. Typical Source-Drain Diode Forward Voltage



**Fig 5.** Normalized On-Resistance Vs. Temperature



**Fig 6.** Typical On-Resistance Vs. Drain Current

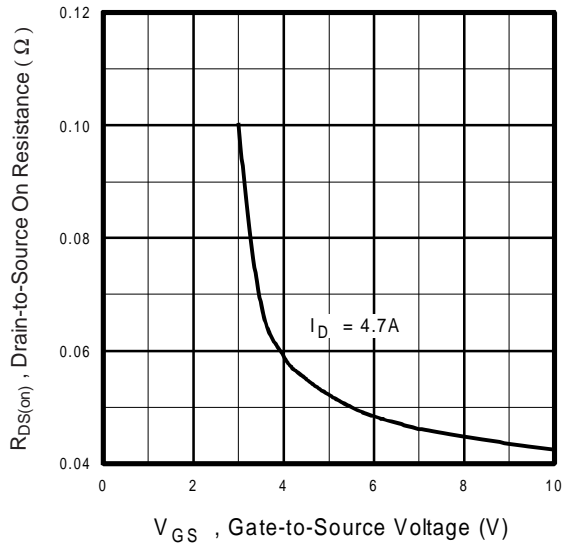

**Fig 7.** Typical On-Resistance Vs. Gate Voltage

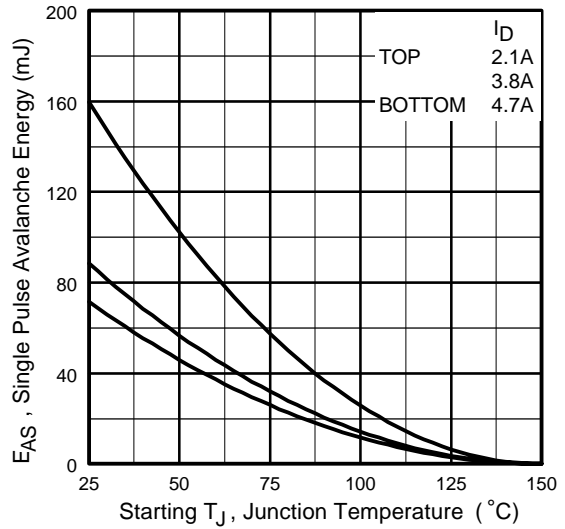

**Fig 8.** Maximum Avalanche Energy Vs. Drain Current

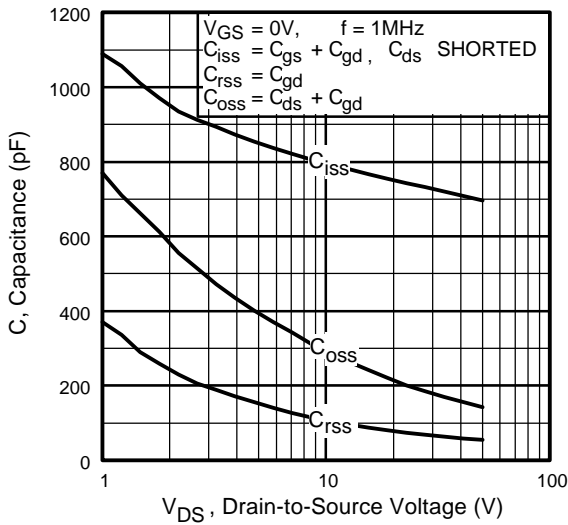

**Fig 9.** Typical Capacitance Vs. Drain-to-Source Voltage

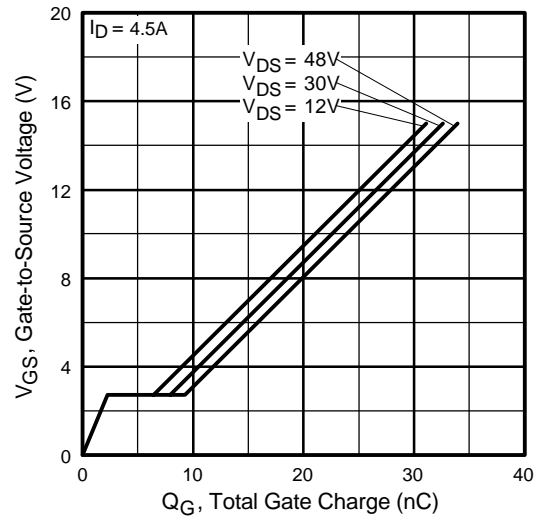

**Fig 10.** Typical Gate Charge Vs. Gate-to-Source Voltage

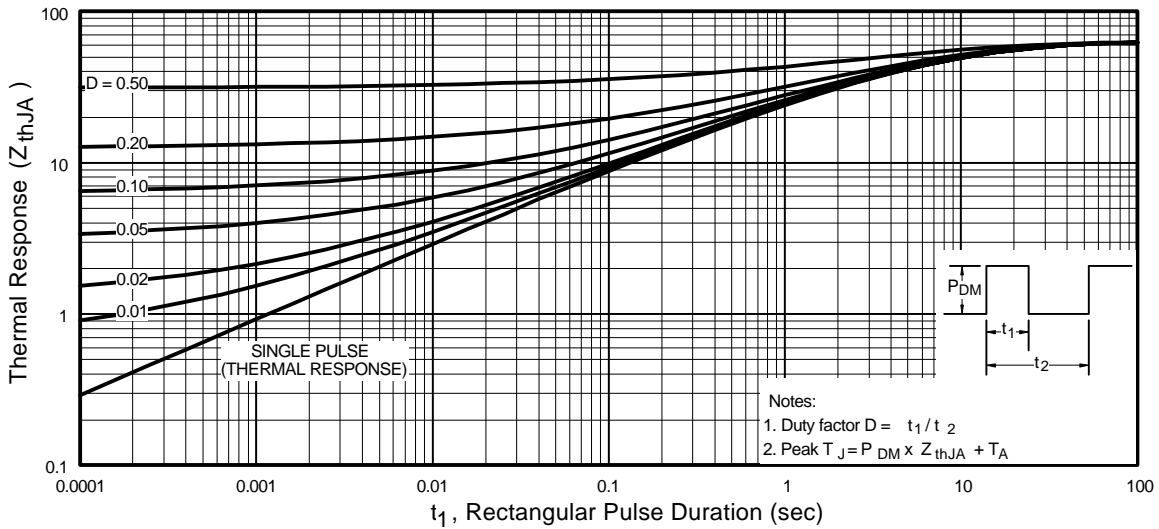

**Fig 11.** Maximum Effective Transient Thermal Impedance, Junction-to-Ambient

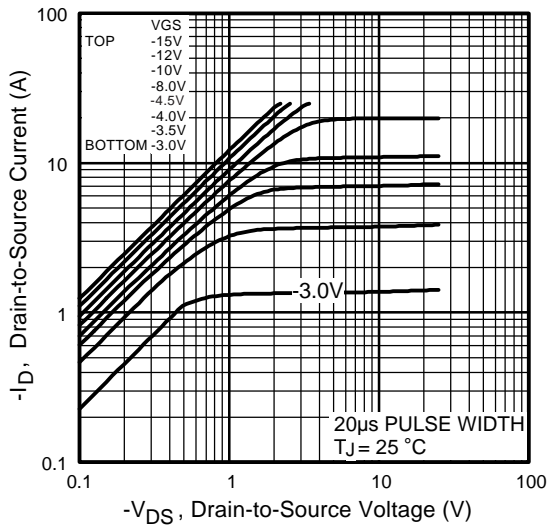

**Fig 12.** Typical Output Characteristics

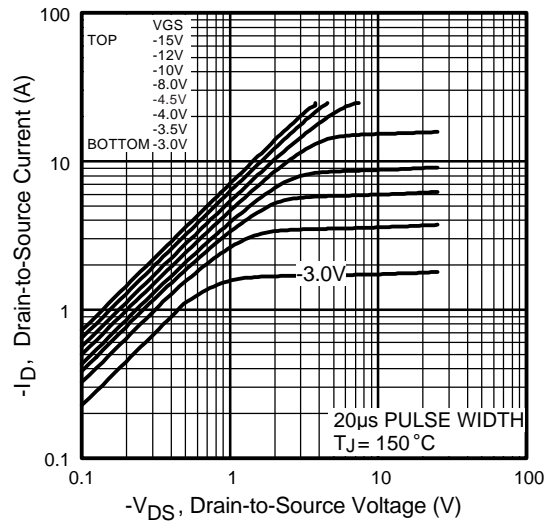

**Fig 13.** Typical Output Characteristics

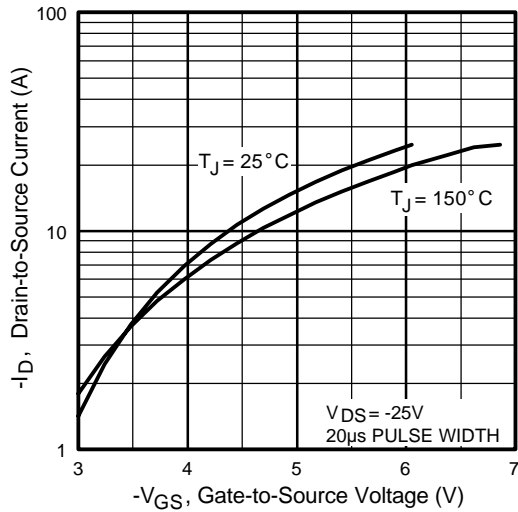

**Fig 14.** Typical Transfer Characteristics

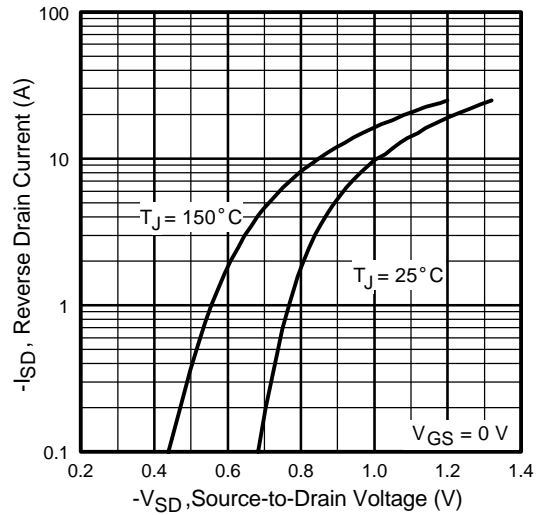

**Fig 15.** Typical Source-Drain Diode Forward Voltage

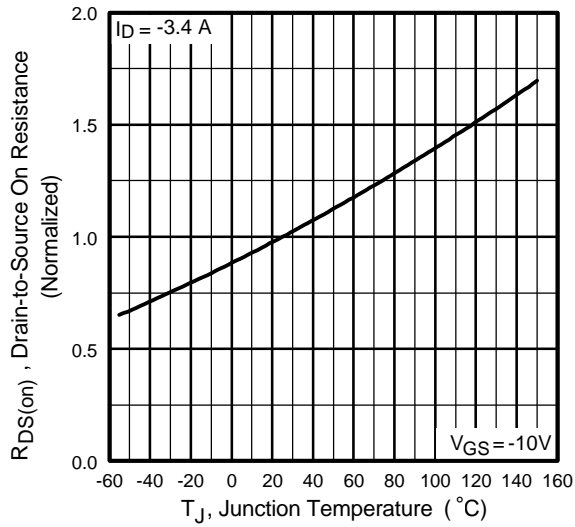

Fig 16. Normalized On-Resistance Vs. Temperature

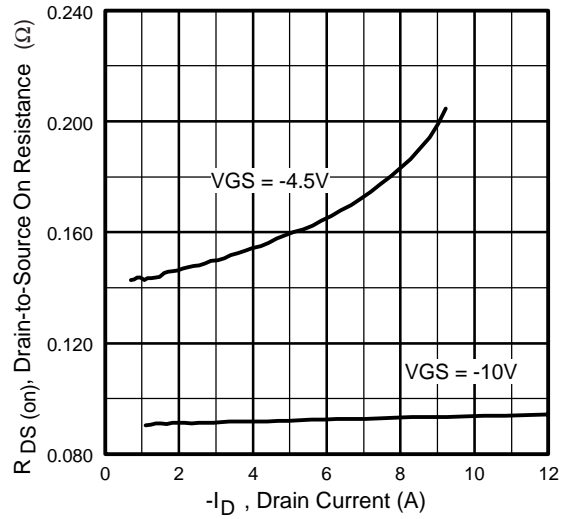

Fig 17. Typical On-Resistance Vs. Drain Current

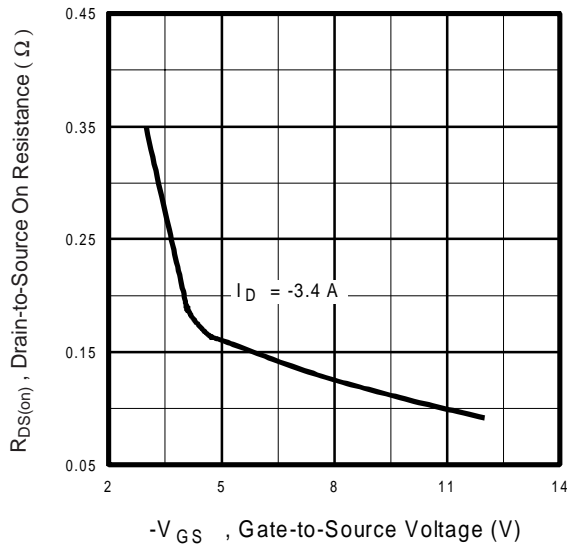

Fig 18. Typical On-Resistance Vs. Gate Voltage

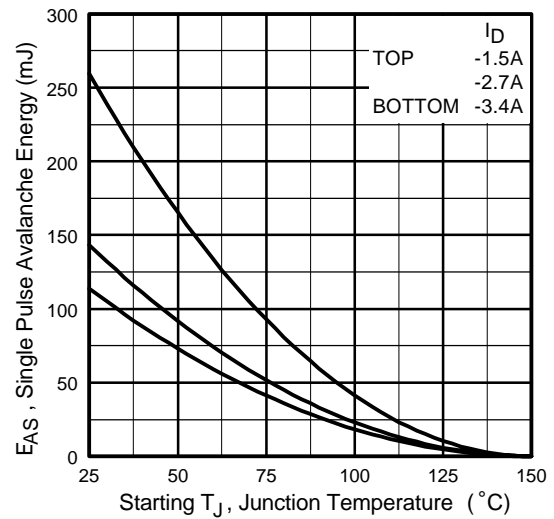
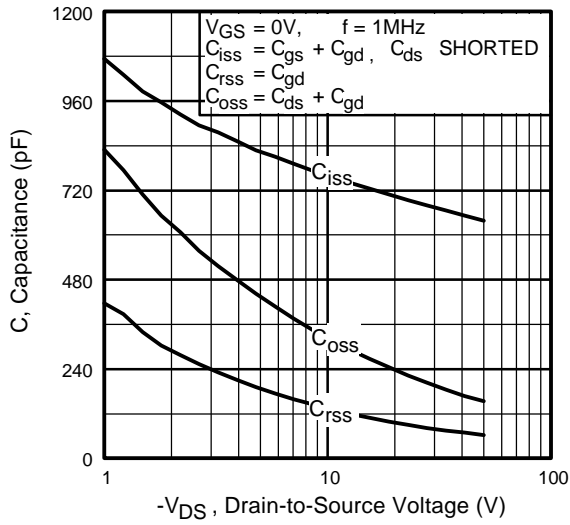
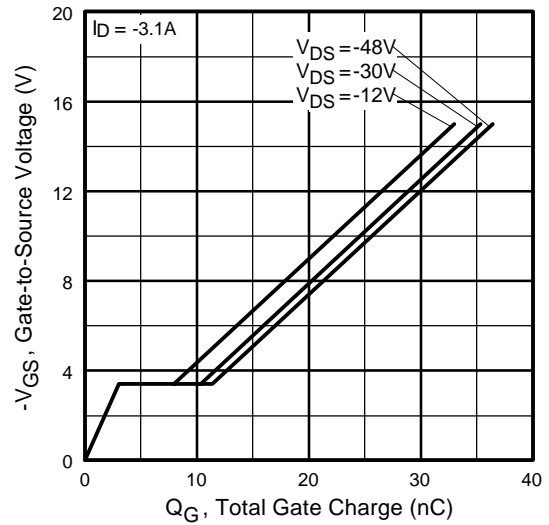

Fig 19. Maximum Avalanche Energy Vs. Drain Current



**Fig 20.** Typical Capacitance Vs. Drain-to-Source Voltage



**Fig 21.** Typical Gate Charge Vs. Gate-to-Source Voltage

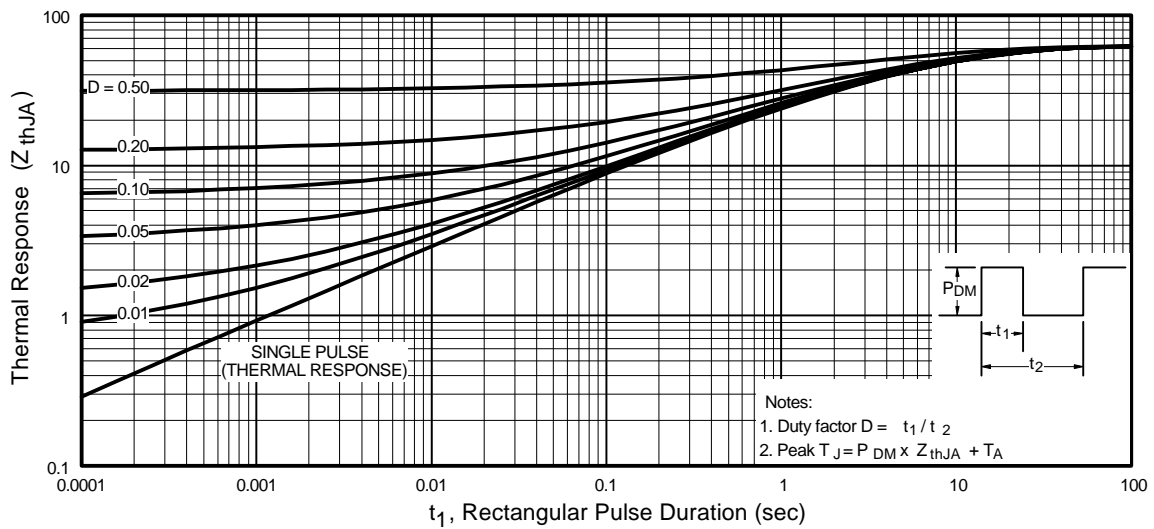

**Fig 22.** Maximum Effective Transient Thermal Impedance, Junction-to-Ambient



## Package Outline SO8 Outline

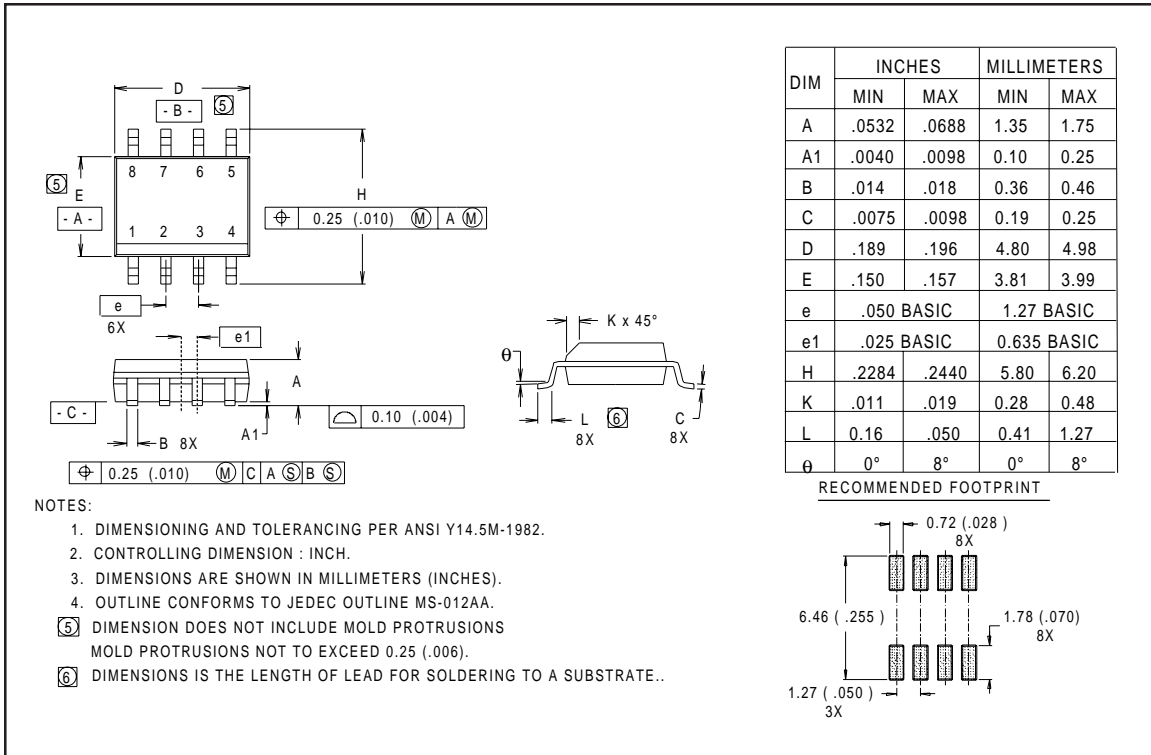

- NOTES:
1. DIMENSIONING AND TOLERANCING PER ANSI Y14.5M-1982.
  2. CONTROLLING DIMENSION : INCH.
  3. DIMENSIONS ARE SHOWN IN MILLIMETERS (INCHES).
  4. OUTLINE CONFORMS TO JEDEC OUTLINE MS-012AA.
  5. DIMENSION DOES NOT INCLUDE MOLD PROTRUSIONS  
 MOLD PROTRUSIONS NOT TO EXCEED 0.25 (.006).
  6. DIMENSIONS IS THE LENGTH OF LEAD FOR SOLDERING TO A SUBSTRATE..

## Part Marking Information

### SO8

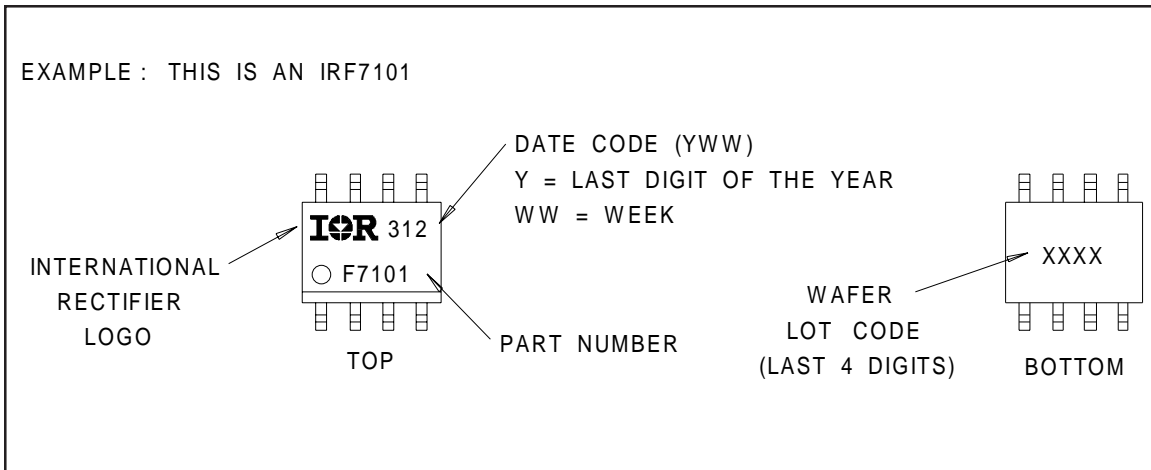

# IRF7343

International  
**IR** Rectifier

## Tape & Reel Information

S08

Dimensions are shown in millimeters (inches)

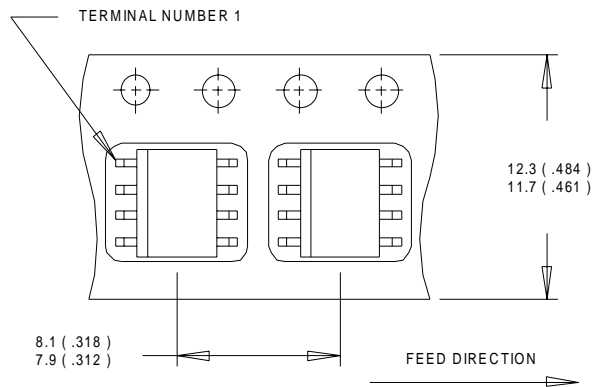

NOTES:

1. CONTROLLING DIMENSION : MILLIMETER.
2. ALL DIMENSIONS ARE SHOWN IN MILLIMETERS(INCHES).
3. OUTLINE CONFORMS TO EIA-481 & EIA-541.

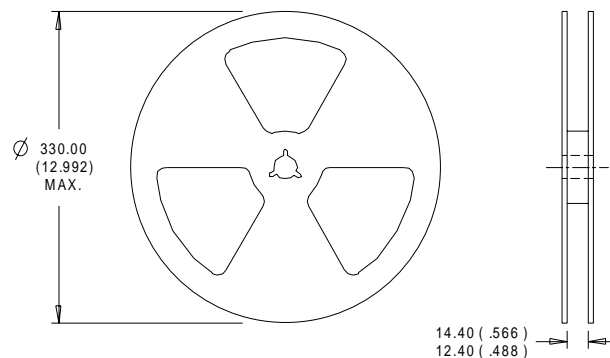

NOTES:

1. CONTROLLING DIMENSION : MILLIMETER.
2. OUTLINE CONFORMS TO EIA-481 & EIA-541.

International  
**IR** Rectifier

**WORLD HEADQUARTERS:** 233 Kansas St., El Segundo, California 90245, Tel: (310) 322 3331

**IR GREAT BRITAIN:** Hurst Green, Oxted, Surrey RH8 9BB, UK Tel: ++ 44 1883 732020

**IR CANADA:** 15 Lincoln Court, Brampton, Ontario L6T3Z2, Tel: (905) 453 2200

**IR GERMANY:** Saalburgstrasse 157, 61350 Bad Homburg Tel: ++ 49 6172 96590

**IR ITALY:** Via Liguria 49, 10071 Borgaro, Torino Tel: ++ 39 11 451 0111

**IR FAR EAST:** K&H Bldg., 2F, 30-4 Nishi-Ikebukuro 3-Chome, Toshima-Ku, Tokyo Japan 171 Tel: 81 3 3983 0086

**IR SOUTHEAST ASIA:** 1 Kim Seng Promenade, Great World City West Tower, 13-11, Singapore 237994 Tel: ++ 65 838 4630

**IR TAIWAN:** 16 Fl. Suite D. 207, Sec. 2, Tun Haw South Road, Taipei, 10673, Taiwan Tel: 886-2-2377-9936

<http://www.irf.com/> Data and specifications subject to change without notice. 2/99