

**SMPS MOSFET**

**IRF740AS/L**

HEXFET® Power MOSFET

**Applications**

- Switch Mode Power Supply ( SMPS )
- Uninterruptable Power Supply
- High speed power switching

V <sub>DSS</sub>	R <sub>ds(on)</sub> max	I <sub>D</sub>
400V	0.55Ω	10A

**Benefits**

- Low Gate Charge Q<sub>g</sub> results in Simple Drive Requirement
- Improved Gate, Avalanche and dynamic dv/dt Ruggedness
- Fully Characterized Capacitance and Avalanche Voltage and Current
- Effective Coss specified ( See AN 1001)

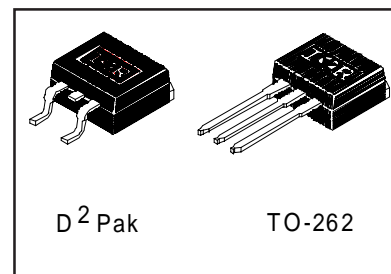

**Absolute Maximum Ratings**

	Parameter	Max.	Units
I <sub>D</sub> @ T <sub>C</sub> = 25°C	Continuous Drain Current, V <sub>GS</sub> @ 10V <sup>⑥</sup>	10	A
I <sub>D</sub> @ T <sub>C</sub> = 100°C	Continuous Drain Current, V <sub>GS</sub> @ 10V <sup>⑥</sup>	6.3	
I <sub>DM</sub>	Pulsed Drain Current <sup>①⑥</sup>	40	
P <sub>D</sub> @ T <sub>A</sub> = 25°C	Power Dissipation	3.1	W
P <sub>D</sub> @ T <sub>C</sub> = 25°C	Power Dissipation	125	
	Linear Derating Factor	1.0	W/°C
V <sub>GS</sub>	Gate-to-Source Voltage	± 30	V
dv/dt	Peak Diode Recovery dv/dt <sup>③⑥</sup>	5.9	V/ns
T <sub>J</sub>	Operating Junction and	-55 to + 150	
T <sub>STG</sub>	Storage Temperature Range		°C
	Soldering Temperature, for 10 seconds	300 (1.6mm from case )	

**Typical SMPS Topologies:**

- Single transistor Flyback Xfmr. Reset
- Single Transistor Forward Xfmr. Reset  
( Both for US Line Input only )

Notes <sup>①</sup> through <sup>⑤</sup> are on page 10

www.irf.com

# IRF740AS/L

International  
IR Rectifier

## Static @ $T_J = 25^\circ\text{C}$ (unless otherwise specified)

	Parameter	Min.	Typ.	Max.	Units	Conditions
$V_{(BR)DSS}$	Drain-to-Source Breakdown Voltage	400	—	—	V	$V_{GS} = 0V, I_D = 250\mu A$
$\Delta V_{(BR)DSS}/\Delta T_J$	Breakdown Voltage Temp. Coefficient	—	0.48	—		$V/^\circ\text{C}$ Reference to $25^\circ\text{C}, I_D = 1mA$ ⑥
$R_{DS(on)}$	Static Drain-to-Source On-Resistance	—	—	0.55	$\Omega$	$V_{GS} = 10V, I_D = 6.0A$ ④
$V_{GS(th)}$	Gate Threshold Voltage	2.0	—	4.0	V	$V_{DS} = V_{GS}, I_D = 250\mu A$
$I_{DSS}$	Drain-to-Source Leakage Current	—	—	25	$\mu A$	$V_{DS} = 400V, V_{GS} = 0V$
		—	—	250		$V_{DS} = 320V, V_{GS} = 0V, T_J = 125^\circ\text{C}$
$I_{GSS}$	Gate-to-Source Forward Leakage	—	—	100	nA	$V_{GS} = 30V$
	Gate-to-Source Reverse Leakage	—	—	-100		$V_{GS} = -30V$

## Dynamic @ $T_J = 25^\circ\text{C}$ (unless otherwise specified)

	Parameter	Min.	Typ.	Max.	Units	Conditions
$g_{fs}$	Forward Transconductance	4.9	—	—	S	$V_{DS} = 50V, I_D = 6.0A$ ⑥
$Q_g$	Total Gate Charge	—	—	36	nC	$I_D = 10A$ $V_{DS} = 320V$ $V_{GS} = 10V$ , See Fig. 6 and 13 ④ ⑥
$Q_{gs}$	Gate-to-Source Charge	—	—	9.9		
$Q_{gd}$	Gate-to-Drain ("Miller") Charge	—	—	16		
$t_{d(on)}$	Turn-On Delay Time	—	10	—	ns	$V_{DD} = 200V$ $I_D = 10A$ $R_G = 10\Omega$ $R_D = 19.5\Omega$ , See Fig. 10 ④ ⑥
$t_r$	Rise Time	—	35	—		
$t_{d(off)}$	Turn-Off Delay Time	—	24	—		
$t_f$	Fall Time	—	22	—		
$C_{iss}$	Input Capacitance	—	1030	—	pF	$V_{GS} = 0V$ $V_{DS} = 25V$ $f = 1.0MHz$ , See Fig. 5 ⑥
$C_{oss}$	Output Capacitance	—	170	—		
$C_{riss}$	Reverse Transfer Capacitance	—	7.7	—		
$C_{oss}$	Output Capacitance	—	1490	—		
$C_{oss}$	Output Capacitance	—	52	—		
$C_{oss\ eff.}$	Effective Output Capacitance	—	61	—		

## Avalanche Characteristics

	Parameter	Typ.	Max.	Units
$E_{AS}$	Single Pulse Avalanche Energy ② ⑥	—	630	mJ
$I_{AR}$	Avalanche Current ①	—	10	A
$E_{AR}$	Repetitive Avalanche Energy ①	—	12.5	mJ

## Thermal Resistance

	Parameter	Typ.	Max.	Units
$R_{\theta JC}$	Junction-to-Case	—	1.0	$^\circ\text{C/W}$
$R_{\theta JA}$	Junction-to-Ambient (PCB Mounted, steady-state)*	—	40	

## Diode Characteristics

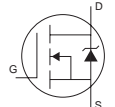
	Parameter	Min.	Typ.	Max.	Units	Conditions
$I_S$	Continuous Source Current (Body Diode)	—	—	10	A	MOSFET symbol showing the integral reverse p-n junction diode. 
$I_{SM}$	Pulsed Source Current (Body Diode) ①	—	—	40		
$V_{SD}$	Diode Forward Voltage	—	—	2.0	V	$T_J = 25^\circ\text{C}, I_S = 10A, V_{GS} = 0V$ ④
$t_{rr}$	Reverse Recovery Time	—	240	360	ns	$T_J = 25^\circ\text{C}, I_F = 10A$
$Q_{rr}$	Reverse Recovery Charge	—	1.9	2.9	$\mu\text{C}$	$di/dt = 100A/\mu\text{s}$ ④ ⑥
$t_{on}$	Forward Turn-On Time	Intrinsic turn-on time is negligible (turn-on is dominated by $L_S + L_D$ )				

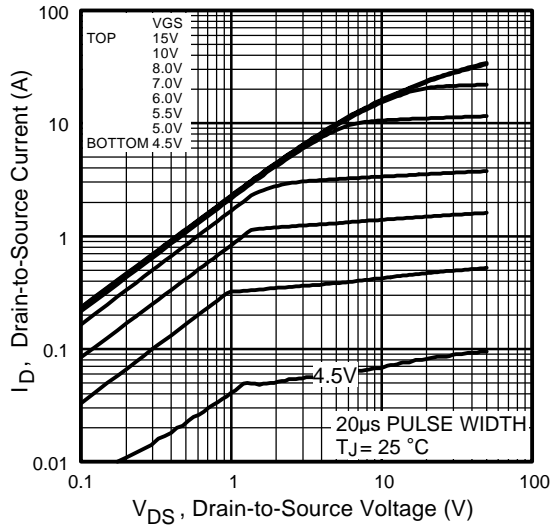

Fig 1. Typical Output Characteristics

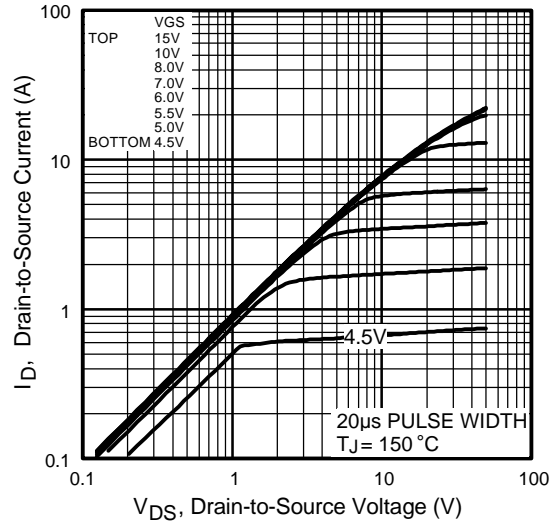

Fig 2. Typical Output Characteristics

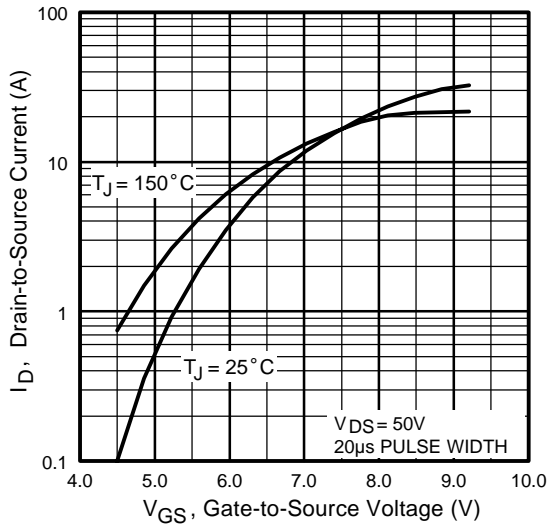

Fig 3. Typical Transfer Characteristics

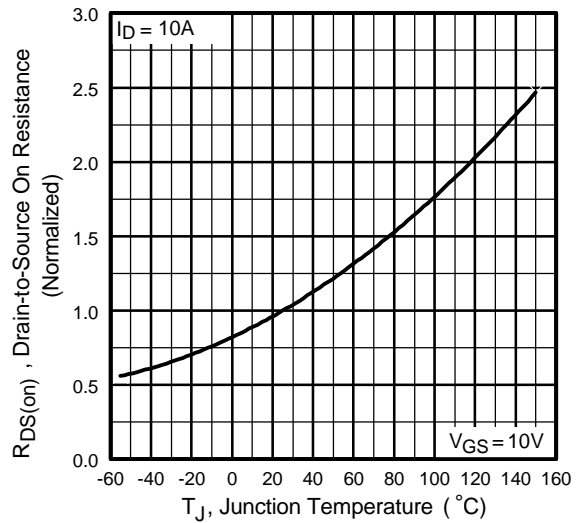
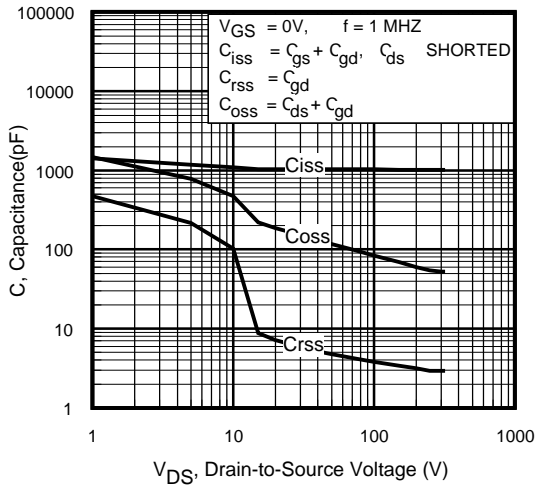
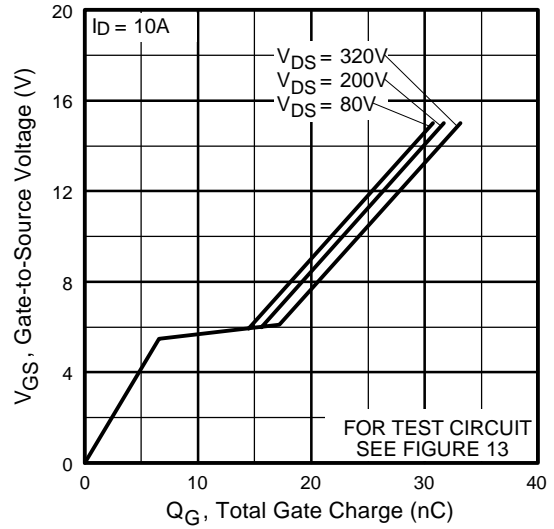

Fig 4. Normalized On-Resistance Vs. Temperature



**Fig 5.** Typical Capacitance Vs. Drain-to-Source Voltage



**Fig 6.** Typical Gate Charge Vs. Gate-to-Source Voltage

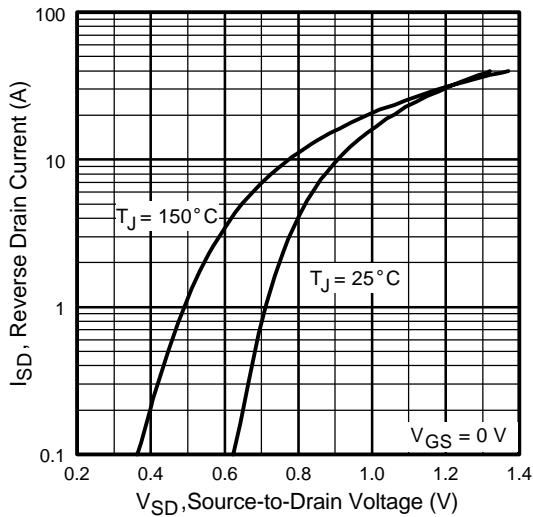

**Fig 7.** Typical Source-Drain Diode Forward Voltage

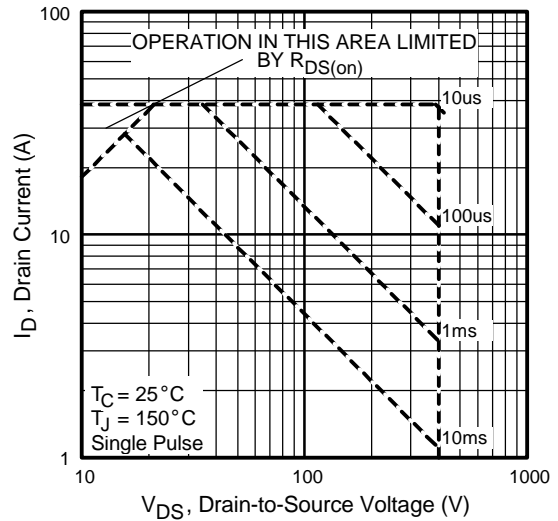

**Fig 8.** Maximum Safe Operating Area

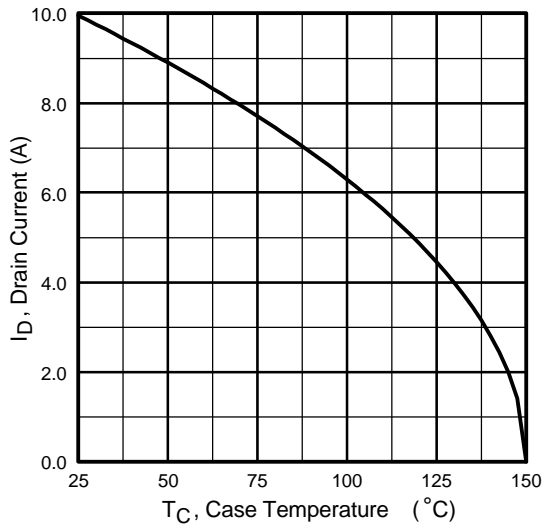

**Fig 9.** Maximum Drain Current Vs. Case Temperature

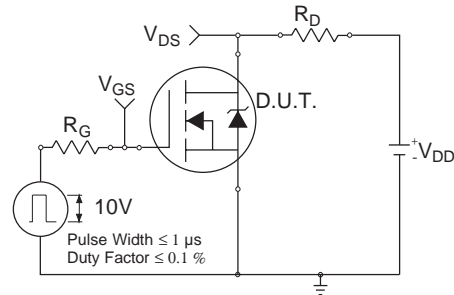

**Fig 10a.** Switching Time Test Circuit



**Fig 10b.** Switching Time Waveforms

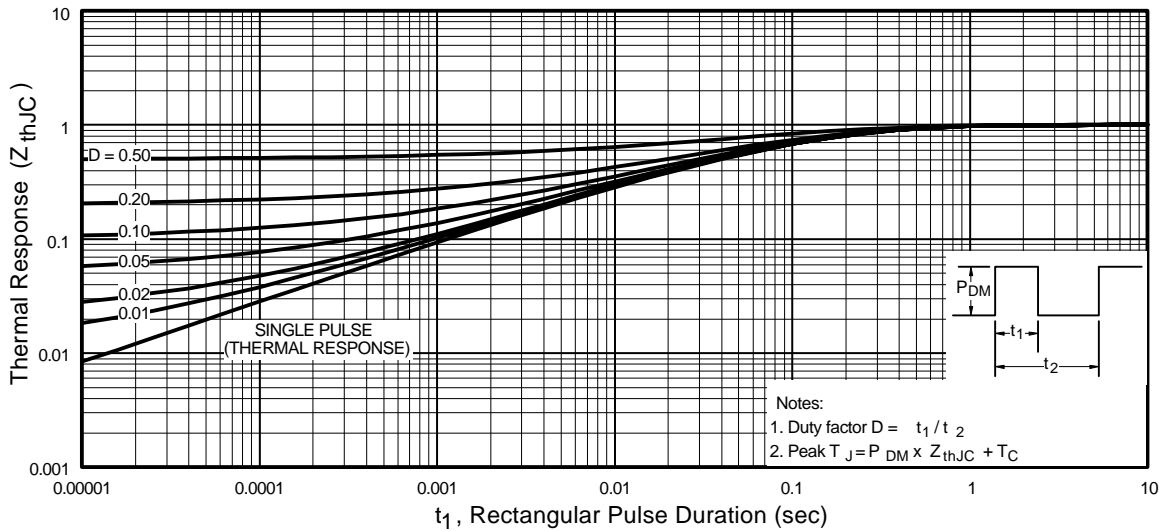

**Fig 11.** Maximum Effective Transient Thermal Impedance, Junction-to-Case

# IRF740AS/L

International  
**IR** Rectifier



**Fig 12a.** Unclamped Inductive Test Circuit



**Fig 12b.** Unclamped Inductive Waveforms



**Fig 13a.** Basic Gate Charge Waveform



**Fig 13b.** Gate Charge Test Circuit

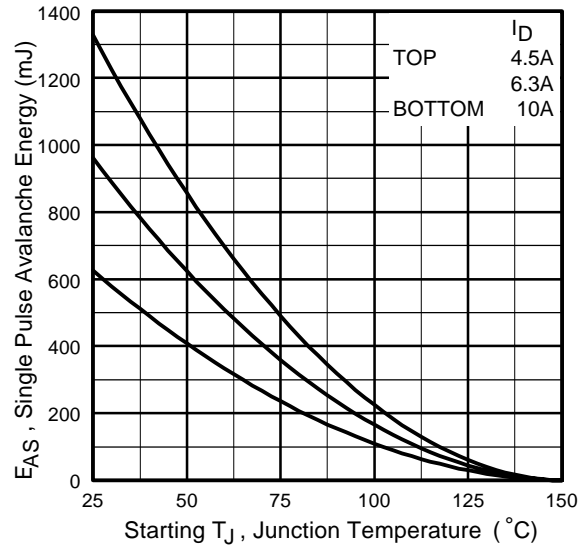

**Fig 12c.** Maximum Avalanche Energy Vs. Drain Current

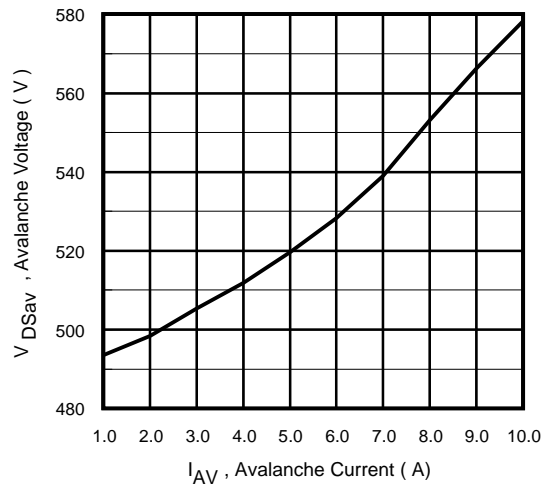

**Fig 12d.** Typical Drain-to-Source Voltage Vs. Avalanche Current

**Peak Diode Recovery dv/dt Test Circuit**



\*  $V_{GS} = 5V$  for Logic Level Devices

**Fig 14.** For N-Channel HEXFETS

# IRF740AS/L

International  
**IR** Rectifier

## D<sup>2</sup>Pak Package Outline

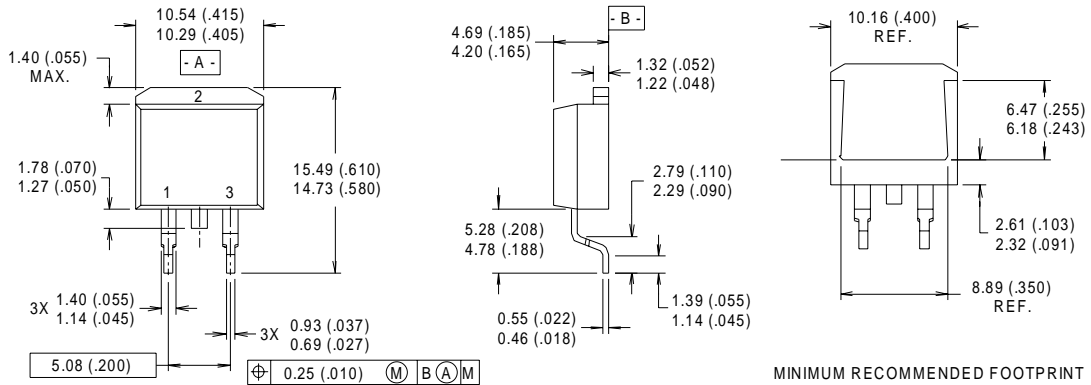

**NOTES:**

- 1 DIMENSIONS AFTER SOLDER DIP.
- 2 DIMENSIONING & TOLERANCING PER ANS Y14.5M, 1982.
- 3 CONTROLLING DIMENSION : INCH.
- 4 HEATSINK & LEAD DIMENSIONS DO NOT INCLUDE BURRS.

**LEAD ASSIGNMENTS**

- 1 - GATE
- 2 - DRAIN
- 3 - SOURCE

## Part Marking Information

### D<sup>2</sup>Pak

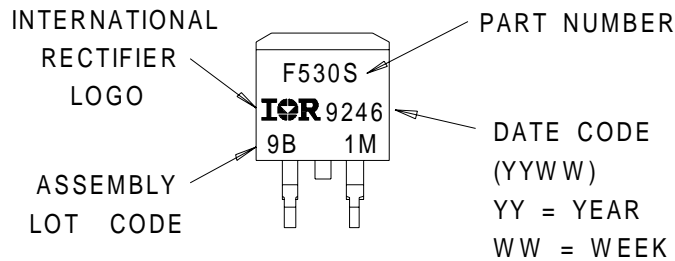



## Package Outline

TO-262 Outline

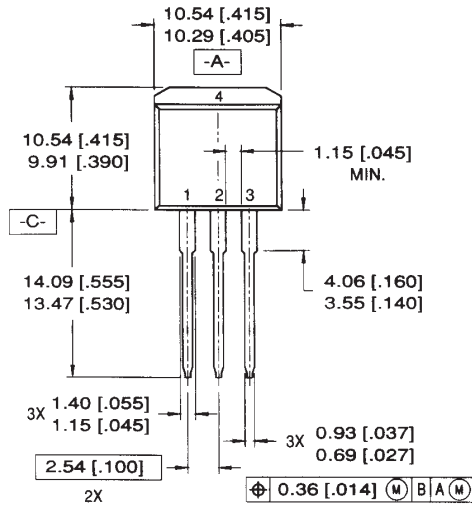

**LEAD ASSIGNMENTS**

- 1 = GATE      3 = SOURCE
- 2 = DRAIN    4 = DRAIN

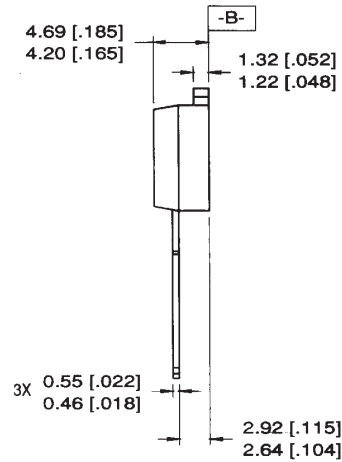

**NOTES:**

1. DIMENSIONING & TOLERANCING PER ANSI Y14.5M-1982
2. CONTROLLING DIMENSION: INCH.
3. DIMENSIONS ARE SHOWN IN MILLIMETERS [INCHES].
4. HEATSINK & LEAD DIMENSIONS DO NOT INCLUDE BURRS.

## Part Marking Information

TO-262

EXAMPLE: THIS IS AN IRL3103L  
 LOT CODE 1789  
 ASSEMBLED ON WW 19, 1997  
 IN THE ASSEMBLY LINE "C"

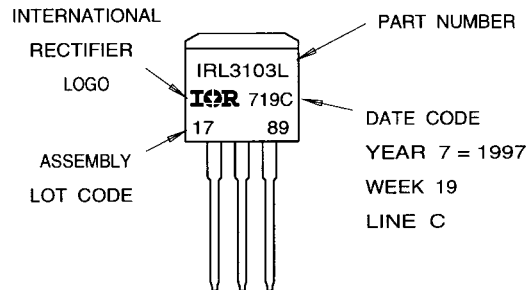

# IRF740AS/L

International  
**IR** Rectifier

## Tape & Reel Information

D<sup>2</sup>Pak

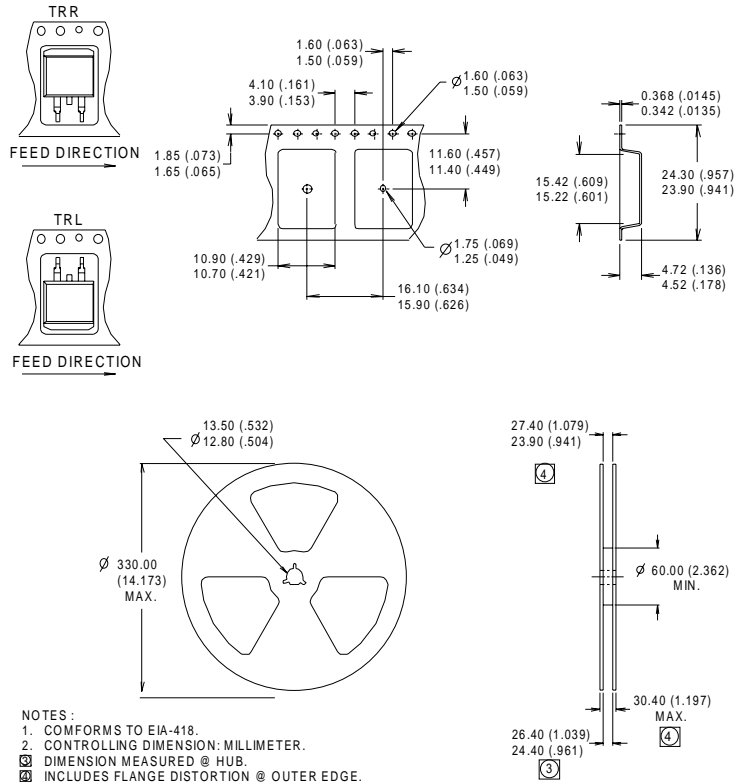

### Notes:

- ① Repetitive rating; pulse width limited by max. junction temperature. ( See fig. 11 )
- ② Starting  $T_J = 25^\circ\text{C}$ ,  $L = 12.6\text{mH}$   
 $R_G = 25\Omega$ ,  $I_{AS} = 10\text{A}$ . (See Figure 12)
- ③  $I_{SD} \leq 10\text{A}$ ,  $di/dt \leq 330\text{A}/\mu\text{s}$ ,  $V_{DD} \leq V_{(BR)DSS}$ ,  
 $T_J \leq 150^\circ\text{C}$
- ④ Pulse width  $\leq 300\mu\text{s}$ ; duty cycle  $\leq 2\%$ .
- ⑤  $C_{OSS}$  eff. is a fixed capacitance that gives the same charging time as  $C_{OSS}$  while  $V_{DS}$  is rising from 0 to 80%  $V_{DSS}$
- ⑥ Uses IRF740A data and test conditions

\* When mounted on 1" square PCB ( FR-4 or G-10 Material ).

For recommended footprint and soldering techniques refer to application note #AN-994.

International  
**IR** Rectifier

**WORLD HEADQUARTERS:** 233 Kansas St., El Segundo, California 90245, Tel: (310) 322 3331

**IR GREAT BRITAIN:** Hurst Green, Oxted, Surrey RH8 9BB, UK Tel: ++ 44 1883 732020

**IR CANADA:** 15 Lincoln Court, Brampton, Ontario L6T3Z2, Tel: (905) 453 2200

**IR GERMANY:** Saalburgstrasse 157, 61350 Bad Homburg Tel: ++ 49 6172 96590

**IR ITALY:** Via Liguria 49, 10071 Borgaro, Torino Tel: ++ 39 11 451 0111

**IR FAR EAST:** K&H Bldg., 2F, 30-4 Nishi-Ikebukuro 3-Chome, Toshima-Ku, Tokyo Japan 171 Tel: 81 3 3983 0086

**IR SOUTHEAST ASIA:** 1 Kim Seng Promenade, Great World City West Tower, 13-11, Singapore 237994 Tel: ++ 65 838 4630

**IR TAIWAN:** 16 Fl. Suite D. 207, Sec. 2, Tun Haw South Road, Taipei, 10673, Taiwan Tel: 886-2-2377-9936

<http://www.irf.com/> Data and specifications subject to change without notice. 9/99