

IRFIZ24V

HEXFET® Power MOSFET

- Advanced Process Technology
- Ultra Low On-Resistance
- Dynamic dv/dt Rating
- 175°C Operating Temperature
- Fast Switching
- Fully Avalanche Rated
- Optimized for SMPS Applications

Description

Advanced HEXFET® Power MOSFETs from International Rectifier utilize advanced processing techniques to achieve extremely low on-resistance per silicon area. This benefit, combined with the fast switching speed and ruggedized device design that HEXFET power MOSFETs are well known for, provides the designer with an extremely efficient and reliable device for use in a wide variety of applications.

The TO-220 Fullpak eliminates the need for additional insulating hardware in commercial-industrial applications. The moulding compound used provides a high isolation capability and a low thermal resistance between the tab and external heatsink. This isolation is equivalent to using a 100 micron mica barrier with standard TO-220 product. The Fullpak is mounted to a heatsink using a single clip or by a single screw fixing.

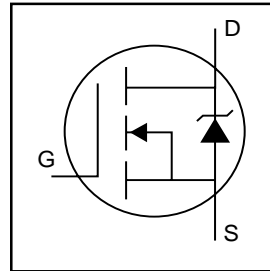

$V_{DSS} = 60V$
$R_{DS(on)} = 0.060\Omega$
$I_D = 14A$

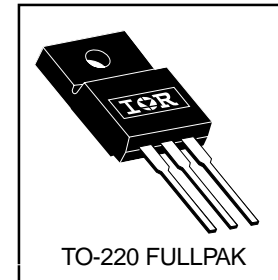

Absolute Maximum Ratings

	Parameter	Max.	Units
$I_D @ T_C = 25^\circ C$	Continuous Drain Current, $V_{GS} @ 10V$	14	A
$I_D @ T_C = 100^\circ C$	Continuous Drain Current, $V_{GS} @ 10V$	10	
I_{DM}	Pulsed Drain Current ①	68	
$P_D @ T_C = 25^\circ C$	Power Dissipation	26	W
	Linear Derating Factor	0.18	W/°C
V_{GS}	Gate-to-Source Voltage	± 20	V
I_{AR}	Avalanche Current ①	17	A
E_{AR}	Repetitive Avalanche Energy ①	4.4	mJ
dv/dt	Peak Diode Recovery dv/dt ③	4.2	V/ns
T_J	Operating Junction and Storage Temperature Range	-55 to + 175	°C
T_{STG}			
	Soldering Temperature, for 10 seconds	300 (1.6mm from case)	
	Mounting torque, 6-32 or M3 srew	10 lbf•in (1.1N•m)	

Thermal Resistance

	Parameter	Typ.	Max.	Units
$R_{\theta JC}$	Junction-to-Case	—	5.7	°C/W
$R_{\theta JA}$	Junction-to-Ambient	—	62	

Electrical Characteristics @ T_J = 25°C (unless otherwise specified)

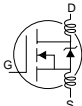
	Parameter	Min.	Typ.	Max.	Units	Conditions
V _{(BR)DSS}	Drain-to-Source Breakdown Voltage	60	—	—	V	V _{GS} = 0V, I _D = 250μA
ΔV _{(BR)DSS} /ΔT _J	Breakdown Voltage Temp. Coefficient	—	0.06	—	V/°C	Reference to 25°C, I _D = 1mA
R _{DS(on)}	Static Drain-to-Source On-Resistance	—	—	60	mΩ	V _{GS} = 10V, I _D = 10A ④
V _{GS(th)}	Gate Threshold Voltage	2.0	—	4.0	V	V _{DS} = V _{GS} , I _D = 250μA
g _{fs}	Forward Transconductance	7.8	—	—	S	V _{DS} = 25V, I _D = 10A④
I _{DSS}	Drain-to-Source Leakage Current	—	—	25	μA	V _{DS} = 60V, V _{GS} = 0V
		—	—	250		V _{DS} = 48V, V _{GS} = 0V, T _J = 150°C
I _{GSS}	Gate-to-Source Forward Leakage	—	—	100	nA	V _{GS} = 20V
	Gate-to-Source Reverse Leakage	—	—	-100		V _{GS} = -20V
Q _g	Total Gate Charge	—	—	23	nC	I _D = 17A ⑦
Q _{gs}	Gate-to-Source Charge	—	—	7.7		V _{DS} = 48V
Q _{gd}	Gate-to-Drain ("Miller") Charge	—	—	6.2		V _{GS} = 10V, See Fig. 6 and 13
t _{d(on)}	Turn-On Delay Time	—	7.6	—	ns	V _{DD} = 30V
t _r	Rise Time	—	46	—		I _D = 17A ⑦
t _{d(off)}	Turn-Off Delay Time	—	21	—		R _G = 18Ω
t _f	Fall Time	—	24	—		V _{GS} = 10V, See Fig. 10 ④
L _D	Internal Drain Inductance	—	4.5	—	nH	Between lead, 6mm (0.25in.) from package and center of die contact
L _S	Internal Source Inductance	—	7.5	—		
C _{iss}	Input Capacitance	—	590	—	pF	V _{GS} = 0V
C _{oss}	Output Capacitance	—	140	—		V _{DS} = 25V
C _{rss}	Reverse Transfer Capacitance	—	23	—		f = 1.0MHz, See Fig. 5
E _{AS}	Single Pulse Avalanche Energy ②	—	140⑤	43⑥		I _{AS} = 17A ⑦, L = 300μH

Source-Drain Ratings and Characteristics

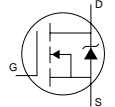
	Parameter	Min.	Typ.	Max.	Units	Conditions
I _S	Continuous Source Current (Body Diode)	—	—	14	A	MOSFET symbol showing the integral reverse p-n junction diode. 
I _{SM}	Pulsed Source Current (Body Diode)①	—	—	68		
V _{SD}	Diode Forward Voltage	—	—	1.3	V	T _J = 25°C, I _S = 17A ⑦, V _{GS} = 0V ④
t _{rr}	Reverse Recovery Time	—	53	79	ns	T _J = 25°C, I _F = 17A ⑦
Q _{rr}	Reverse Recovery Charge	—	90	130	nC	di/dt = 100A/μs ④
t _{on}	Forward Turn-On Time	Intrinsic turn-on time is negligible (turn-on is dominated by L _S +L _D)				

Notes:

- ① Repetitive rating; pulse width limited by max. junction temperature. (See fig. 11)
- ② Starting T_J = 25°C, L = 300μH
R_G = 25Ω, I_{AS} = 14A. (See Figure 12)
- ③ I_{SD} ≤ 14A, di/dt ≤ 240A/μs, V_{DD} ≤ V_{(BR)DSS},
T_J ≤ 175°C

- ④ Pulse width ≤ 400μs; duty cycle ≤ 2%.
- ⑤ This is a typical value at device destruction and represents operation outside rated limits.
- ⑥ This is a calculated value limited to T_J = 175°C .
- ⑦ I_D = 17A is copied from TO-220 device.

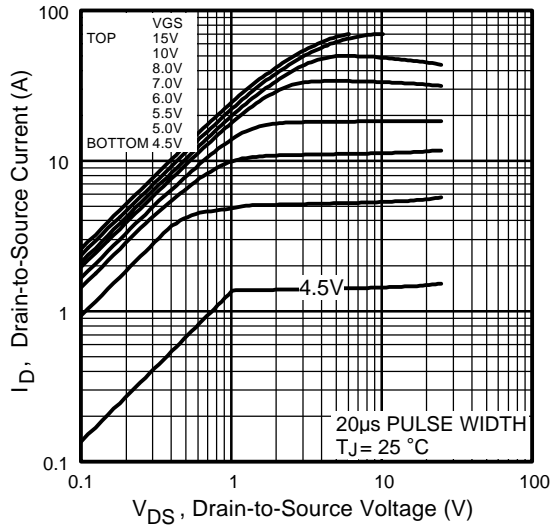

Fig 1. Typical Output Characteristics

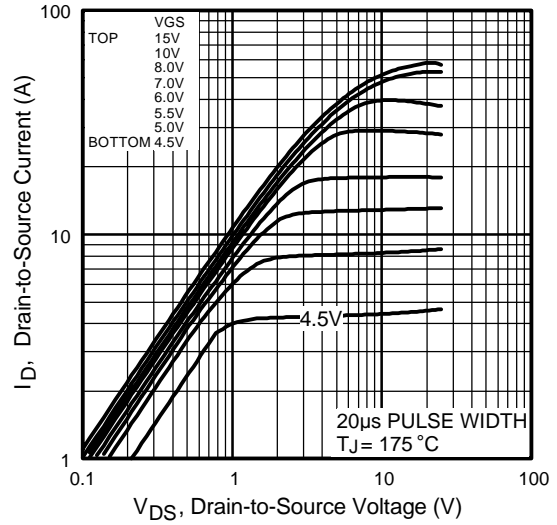

Fig 2. Typical Output Characteristics

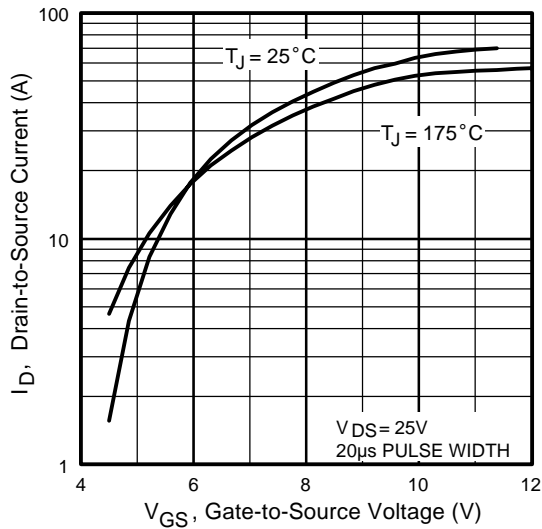

Fig 3. Typical Transfer Characteristics

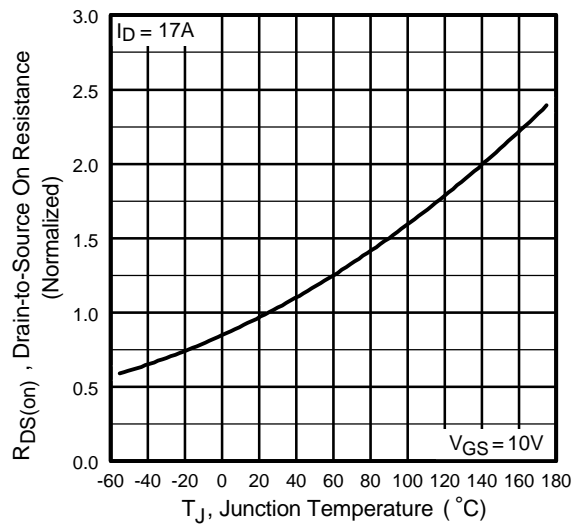

Fig 4. Normalized On-Resistance Vs. Temperature

IRFIZ24V

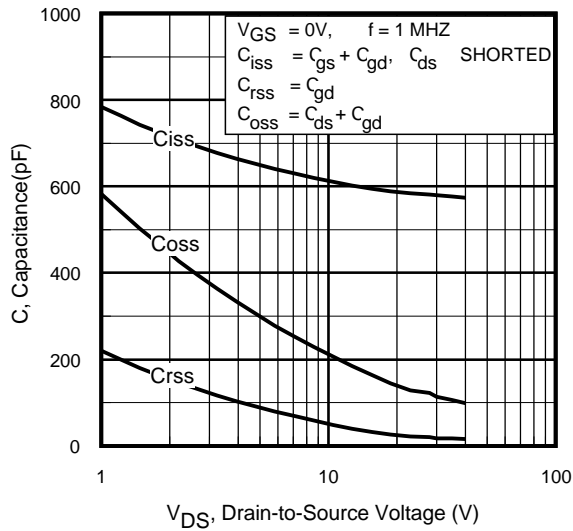

Fig 5. Typical Capacitance Vs. Drain-to-Source Voltage

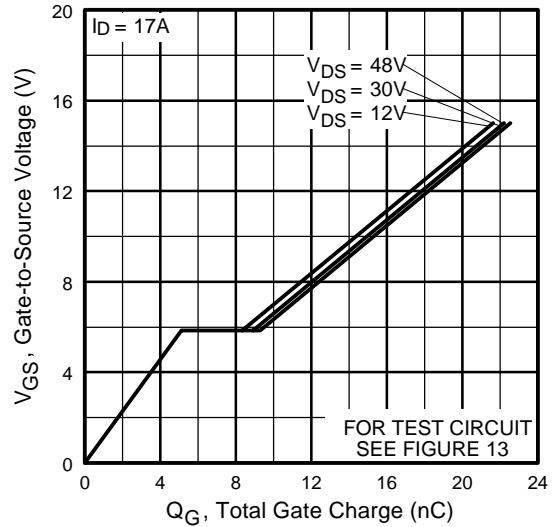

Fig 6. Typical Gate Charge Vs. Gate-to-Source Voltage

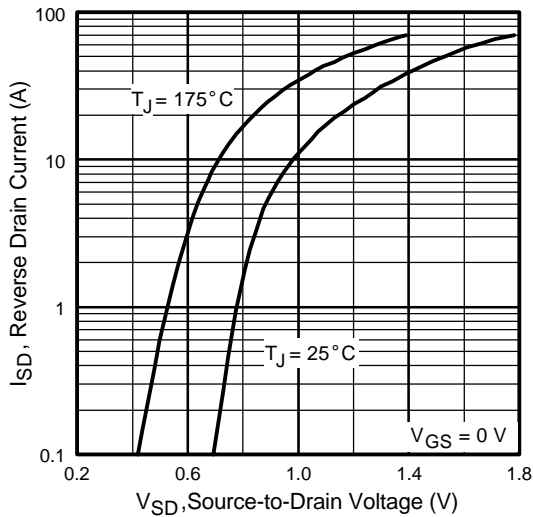

Fig 7. Typical Source-Drain Diode Forward Voltage

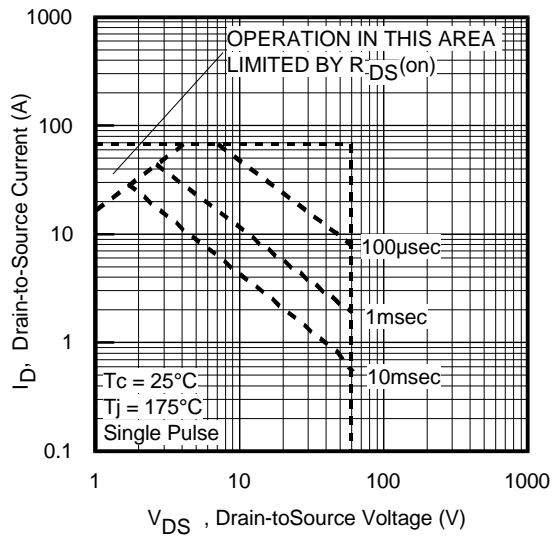

Fig 8. Maximum Safe Operating Area

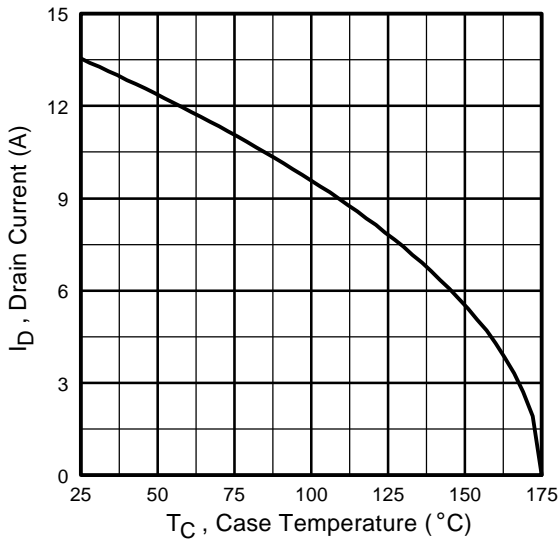

Fig 9. Maximum Drain Current Vs. Case Temperature

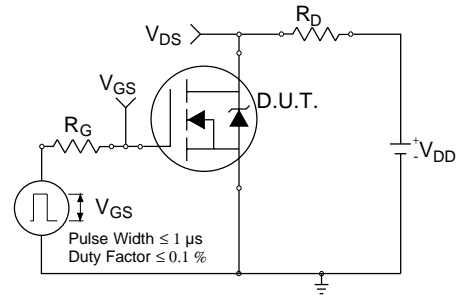

Fig 10a. Switching Time Test Circuit



Fig 10b. Switching Time Waveforms

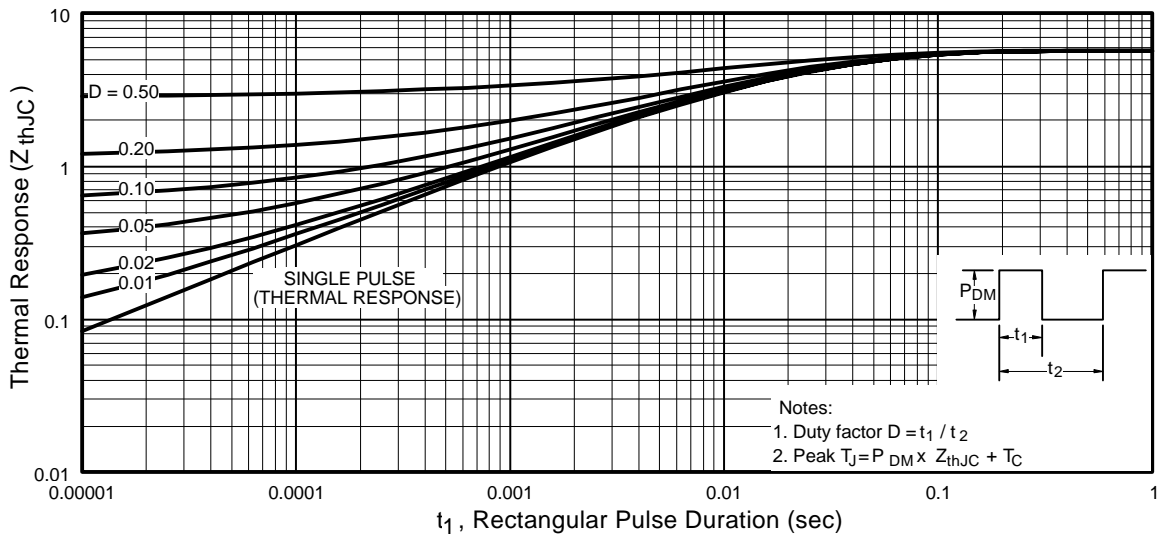

Fig 11. Maximum Effective Transient Thermal Impedance, Junction-to-Case

IRFIZ24V

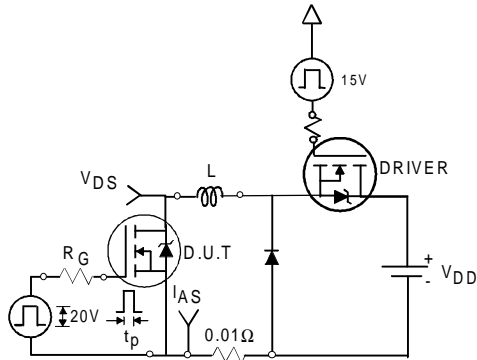

Fig 12a. Unclamped Inductive Test Circuit



Fig 12b. Unclamped Inductive Waveforms

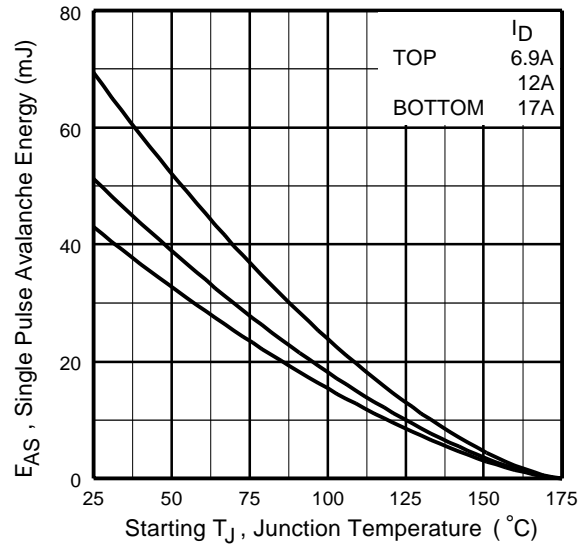

Fig 12c. Maximum Avalanche Energy Vs. Drain Current

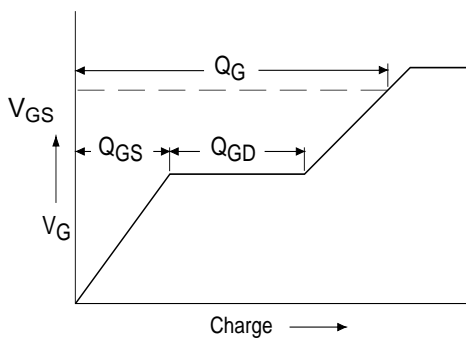
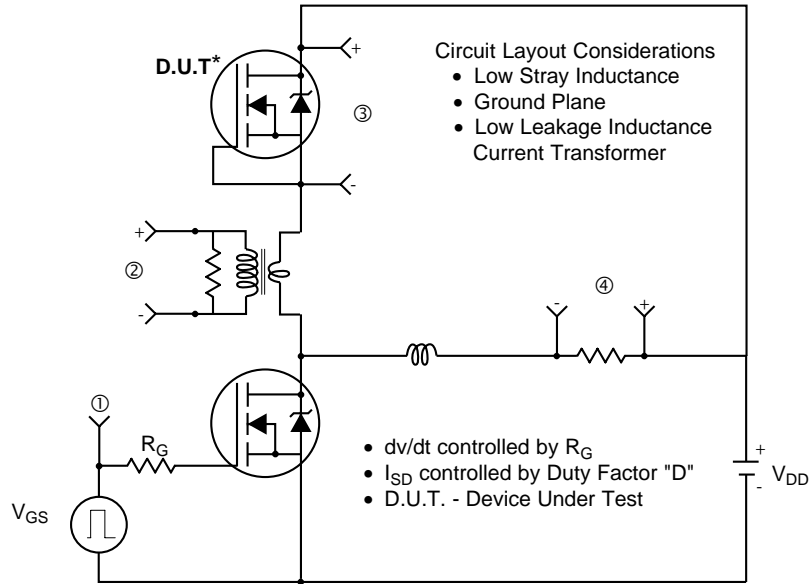

Fig 13a. Basic Gate Charge Waveform

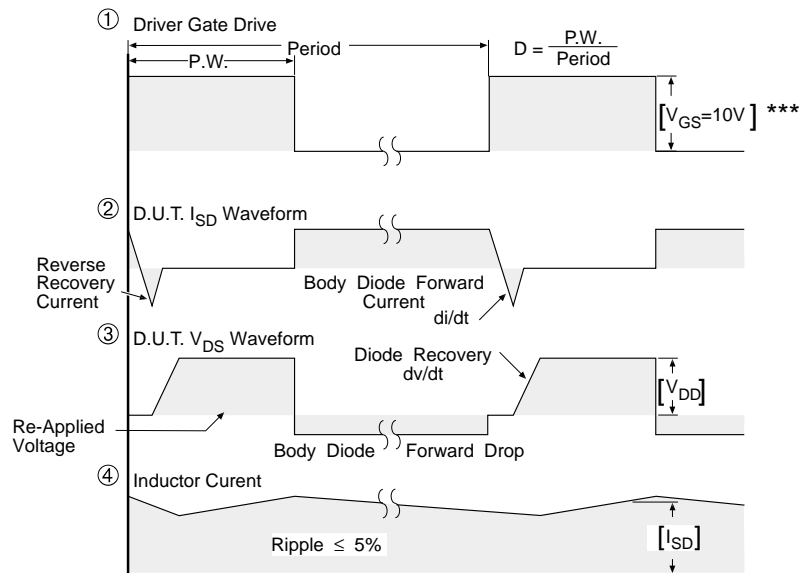

Fig 13b. Gate Charge Test Circuit

Peak Diode Recovery dv/dt Test Circuit



* Reverse Polarity of D.U.T for P-Channel



*** $V_{GS} = 5.0V$ for Logic Level and 3V Drive Devices

Fig 14. For N-channel HEXFET[®] power MOSFETs

IRFIZ24V

International
IR Rectifier

Package Outline TO-220 Fullpak Outline

Dimensions are shown in millimeters (inches)

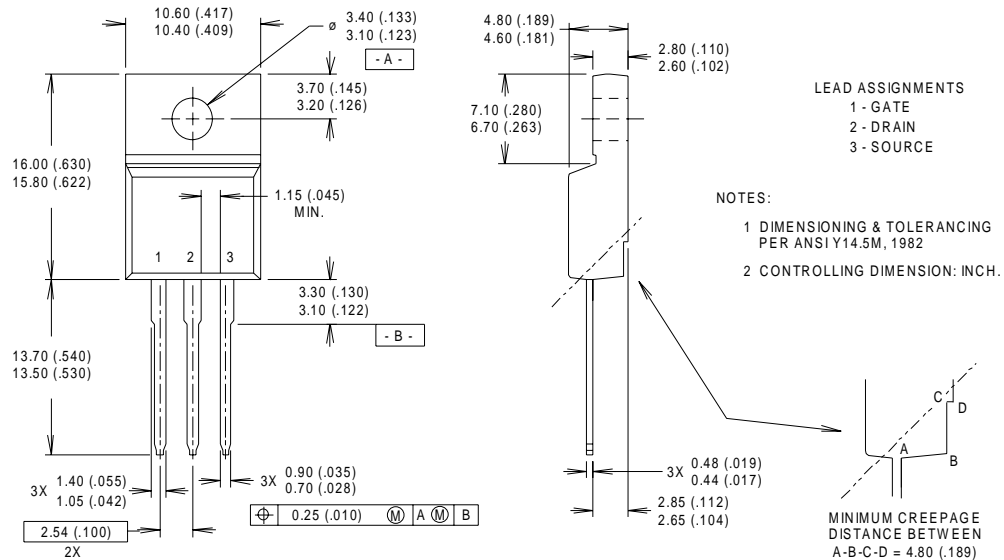

Part Marking Information

TO-220 Fullpak

EXAMPLE : THIS IS AN IRFI840G
WITH ASSEMBLY
LOT CODE E401

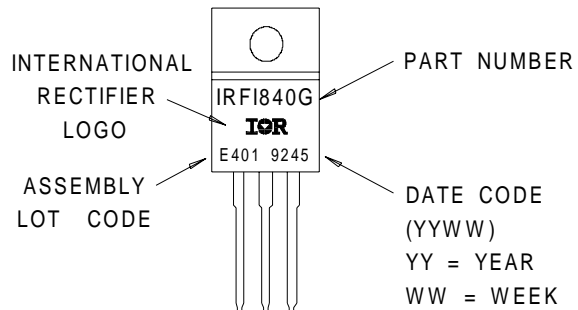

Data and specifications subject to change without notice.
This product has been designed and qualified for the industrial market.
Qualification Standards can be found on IR's Web site.

International
IR Rectifier

IR WORLD HEADQUARTERS: 233 Kansas St., El Segundo, California 90245, USA Tel: (310) 252-7105
TAC Fax: (310) 252-7903

Visit us at www.irf.com for sales contact information.3/01

www.irf.com