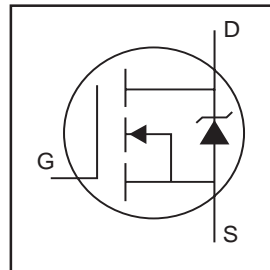


# IRFIZ34V

HEXFET<sup>®</sup> Power MOSFET

- Advanced Process Technology
- Ultra Low On-Resistance
- Dynamic dv/dt Rating
- 175°C Operating Temperature
- Fast Switching
- Fully Avalanche Rated
- Optimized for SMPS Applications

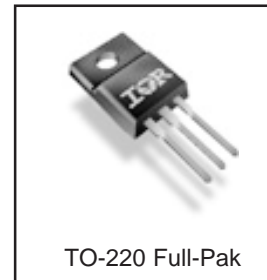


$V_{DSS} = 60V$
$R_{DS(on)} = 28m\Omega$
$I_D = 20A$

## Description

Advanced HEXFET<sup>®</sup> Power MOSFETs from International Rectifier utilize advanced processing techniques to achieve extremely low on-resistance per silicon area. This benefit, combined with the fast switching speed and ruggedized device design that HEXFET power MOSFETs are well known for, provides the designer with an extremely efficient and reliable device for use in a wide variety of applications.

The TO-220 Fullpak eliminates the need for additional insulating hardware in commercial-industrial applications. The moulding compound used provides a high isolation capability and a low thermal resistance between the tab and external heatsink. This isolation is equivalent to using a 100 micron mica barrier with standard TO-220 product. The Fullpak is mounted to a heatsink using a single clip or by a single screw fixing.



TO-220 Full-Pak

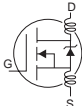
## Absolute Maximum Ratings

	Parameter	Max.	Units
$I_D @ T_C = 25^\circ C$	Continuous Drain Current, $V_{GS} @ 10V$	20	A
$I_D @ T_C = 100^\circ C$	Continuous Drain Current, $V_{GS} @ 10V$	14	
$I_{DM}$	Pulsed Drain Current ①	120	
$P_D @ T_C = 25^\circ C$	Power Dissipation	30	W
	Linear Derating Factor	0.20	W/°C
$V_{GS}$	Gate-to-Source Voltage	$\pm 20$	V
$E_{AS}$	Single Pulse Avalanche Energy ② ⑤	81	mJ
$I_{AR}$	Avalanche Current ①	30	A
$E_{AR}$	Repetitive Avalanche Energy ①	3.0	mJ
dv/dt	Peak Diode Recovery dv/dt ③ ⑤	4.5	V/ns
$T_J$	Operating Junction and Storage Temperature Range	-55 to + 175	°C
$T_{STG}$			
	Mounting torque, 6-32 or M3 srew	10 lbf•in (1.1N•m)	

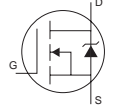
## Thermal Resistance

	Parameter	Typ.	Max.	Units
$R_{\theta JC}$	Junction-to-Case	—	5.0	°C/W
$R_{\theta JA}$	Junction-to-Ambient	—	65	

## Electrical Characteristics @ $T_J = 25^\circ\text{C}$ (unless otherwise specified)

	Parameter	Min.	Typ.	Max.	Units	Conditions
$V_{(BR)DSS}$	Drain-to-Source Breakdown Voltage	60	—	—	V	$V_{GS} = 0V, I_D = 250\mu A$
$\Delta V_{(BR)DSS}/\Delta T_J$	Breakdown Voltage Temp. Coefficient	—	0.062	—	V/°C	Reference to $25^\circ\text{C}, I_D = 1\text{mA}$ ⑤
$R_{DS(on)}$	Static Drain-to-Source On-Resistance	—	—	28	mΩ	$V_{GS} = 10V, I_D = 18A$ ④
$V_{GS(th)}$	Gate Threshold Voltage	2.0	—	4.0	V	$V_{DS} = V_{GS}, I_D = 250\mu A$
$g_{fs}$	Forward Transconductance	15	—	—	S	$V_{DS} = 25V, I_D = 18A$ ④⑤
$I_{DSS}$	Drain-to-Source Leakage Current	—	—	25	μA	$V_{DS} = 60V, V_{GS} = 0V$
		—	—	250		$V_{DS} = 48V, V_{GS} = 0V, T_J = 150^\circ\text{C}$
$I_{GSS}$	Gate-to-Source Forward Leakage	—	—	100	nA	$V_{GS} = 20V$
	Gate-to-Source Reverse Leakage	—	—	-100		$V_{GS} = -20V$
$Q_g$	Total Gate Charge	—	—	49	nC	$I_D = 30A$
$Q_{gs}$	Gate-to-Source Charge	—	—	12		$V_{DS} = 48V$
$Q_{gd}$	Gate-to-Drain ("Miller") Charge	—	—	18		$V_{GS} = 10V$ , See Fig. 6 and 13⑤
$t_{d(on)}$	Turn-On Delay Time	—	10	—	ns	$V_{DD} = 30V$
$t_r$	Rise Time	—	65	—		$I_D = 30A$
$t_{d(off)}$	Turn-Off Delay Time	—	31	—		$R_G = 12\Omega$
$t_f$	Fall Time	—	40	—		$V_{GS} = 10V$ , See Fig. 10 ④⑤
$L_D$	Internal Drain Inductance	—	4.5	—	nH	Between lead, 6mm (0.25in.) from package and center of die contact
$L_S$	Internal Source Inductance	—	7.5	—		
$C_{iss}$	Input Capacitance	—	1120	—	pF	$V_{GS} = 0V$
$C_{oss}$	Output Capacitance	—	250	—		$V_{DS} = 25V$
$C_{rss}$	Reverse Transfer Capacitance	—	59	—		$f = 1.0\text{MHz}$ , See Fig. 5⑤

## Source-Drain Ratings and Characteristics

	Parameter	Min.	Typ.	Max.	Units	Conditions
$I_S$	Continuous Source Current (Body Diode)	—	—	20	A	MOSFET symbol showing the integral reverse p-n junction diode. 
$I_{SM}$	Pulsed Source Current (Body Diode)①	—	—	120		
$V_{SD}$	Diode Forward Voltage	—	—	1.6	V	$T_J = 25^\circ\text{C}, I_S = 30A, V_{GS} = 0V$ ④
$t_{rr}$	Reverse Recovery Time	—	70	110	ns	$T_J = 25^\circ\text{C}, I_F = 30A$
$Q_{rr}$	Reverse Recovery Charge	—	99	150	nC	$di/dt = 100A/\mu s$ ④⑤
$t_{on}$	Forward Turn-On Time	Intrinsic turn-on time is negligible (turn-on is dominated by $L_S+L_D$ )				

### Notes:

- ① Repetitive rating; pulse width limited by max. junction temperature. ( See fig. 11 )
- ② Starting  $T_J = 25^\circ\text{C}$ ,  $L = 180\mu\text{H}$   
 $R_G = 25\Omega, I_{AS} = 30A$ . (See Figure 12)
- ③  $I_{SD} \leq 30A, di/dt \leq 250A/\mu s, V_{DD} \leq V_{(BR)DSS}, T_J \leq 175^\circ\text{C}$
- ④ Pulse width  $\leq 400\mu s$ ; duty cycle  $\leq 2\%$ .
- ⑤ Uses IRFZ34V data and test conditions

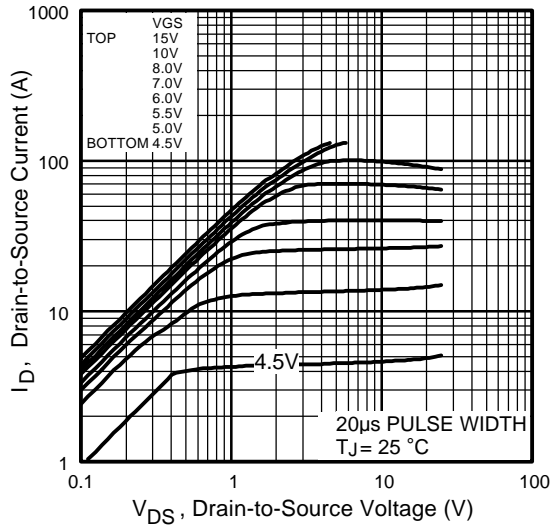


Fig 1. Typical Output Characteristics

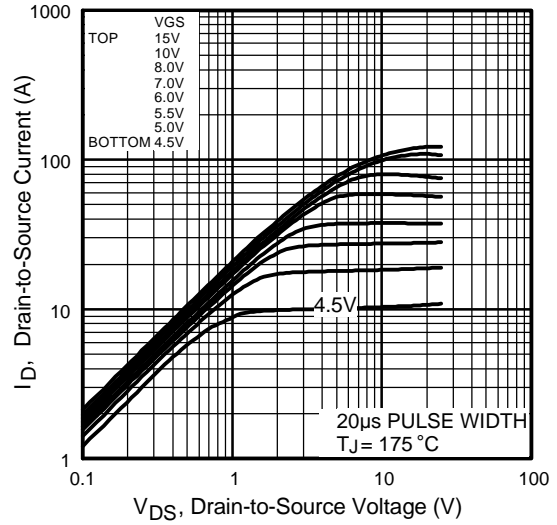


Fig 2. Typical Output Characteristics

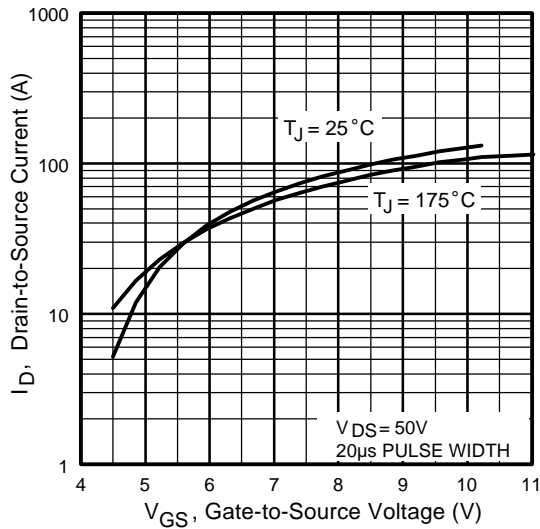


Fig 3. Typical Transfer Characteristics

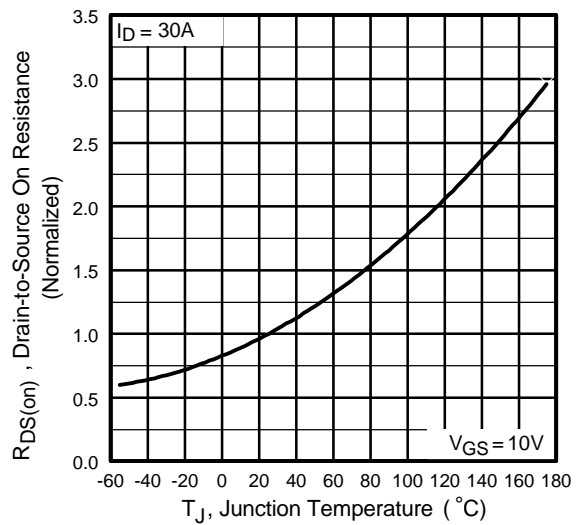
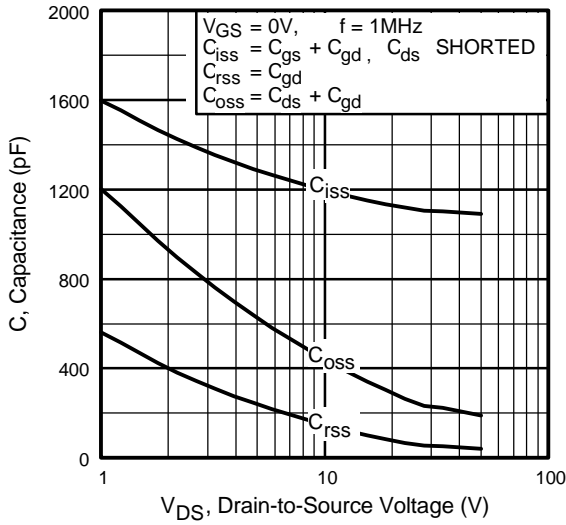
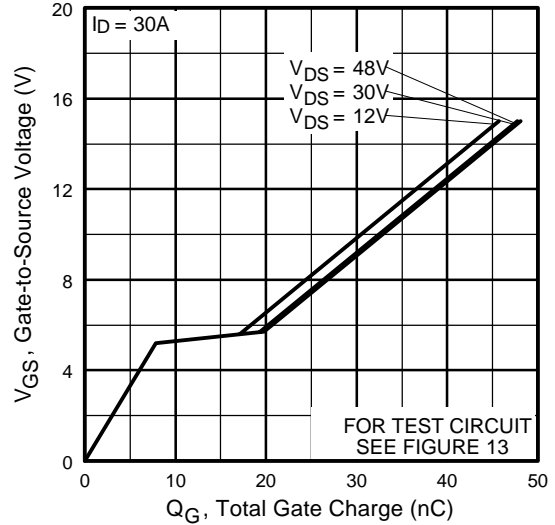


Fig 4. Normalized On-Resistance Vs. Temperature

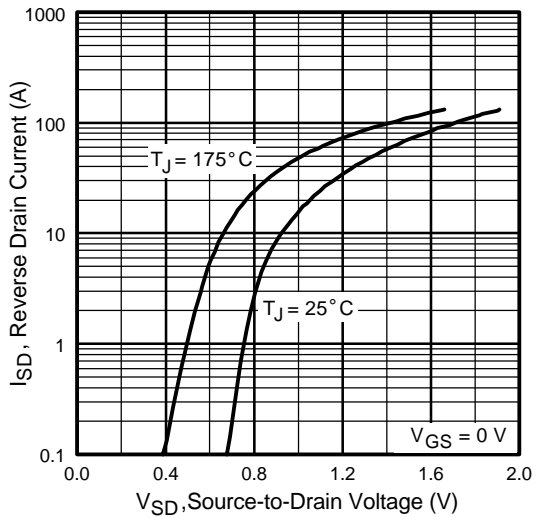
# IRFIZ34V



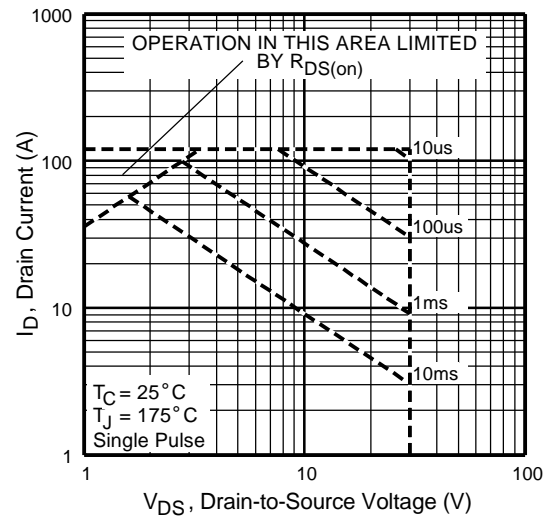
**Fig 5.** Typical Capacitance Vs. Drain-to-Source Voltage



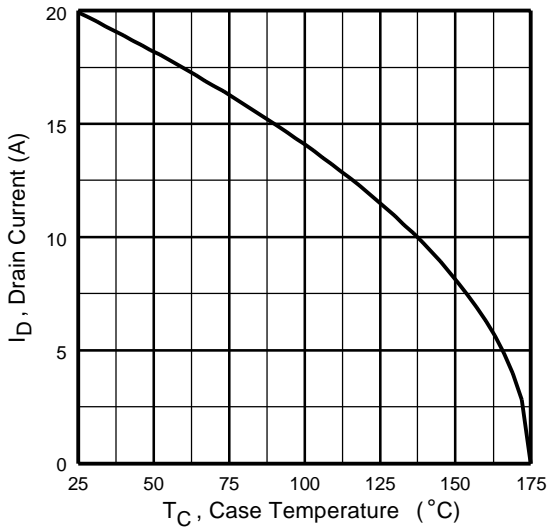
**Fig 6.** Typical Gate Charge Vs. Gate-to-Source Voltage



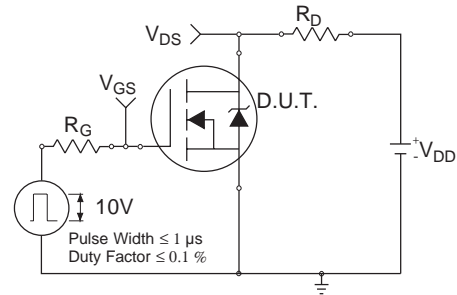
**Fig 7.** Typical Source-Drain Diode Forward Voltage



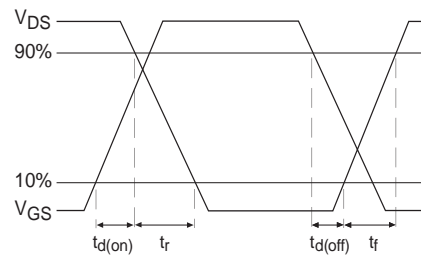
**Fig 8.** Maximum Safe Operating Area



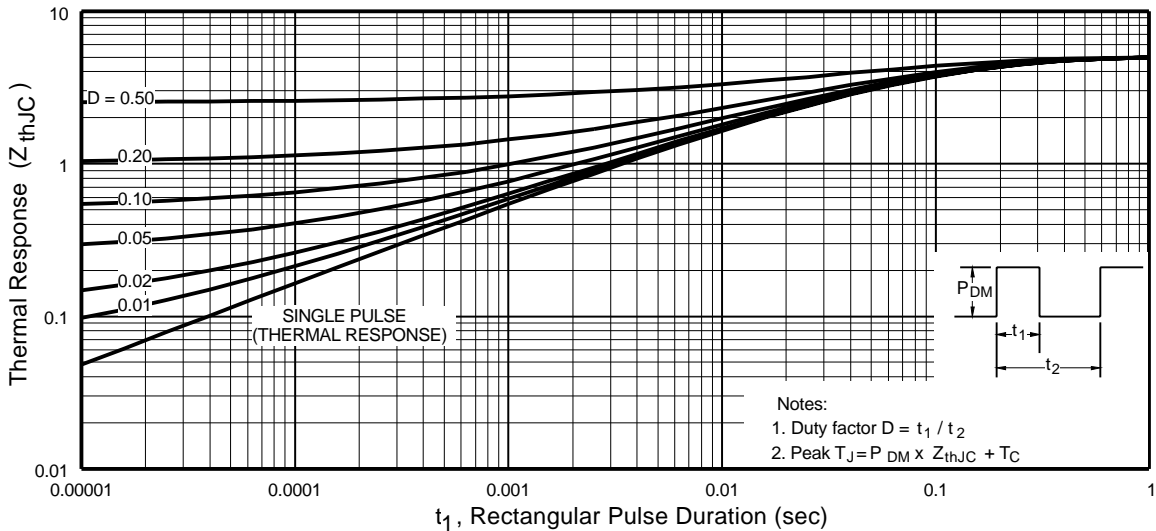
**Fig 9.** Maximum Drain Current Vs. Case Temperature



**Fig 10a.** Switching Time Test Circuit

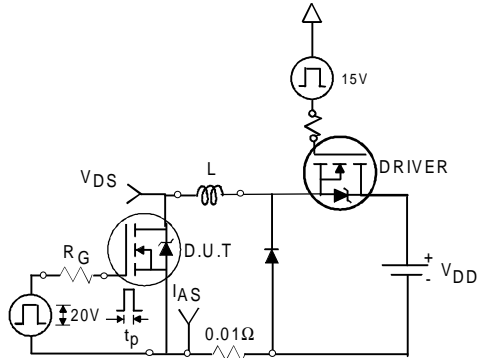


**Fig 10b.** Switching Time Waveforms

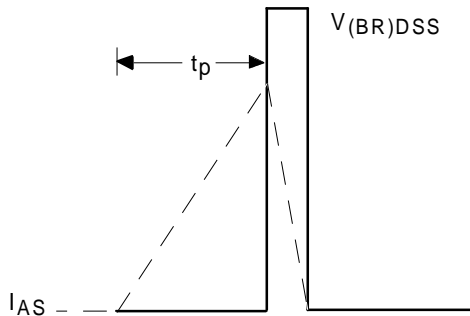


**Fig 11.** Maximum Effective Transient Thermal Impedance, Junction-to-Case

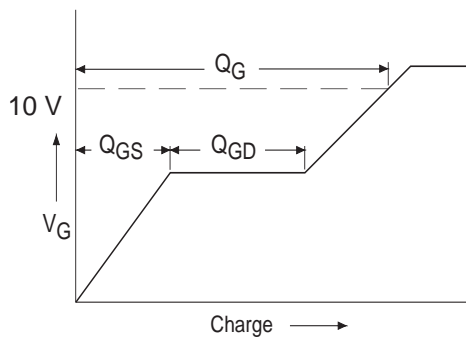
# IRFIZ34V



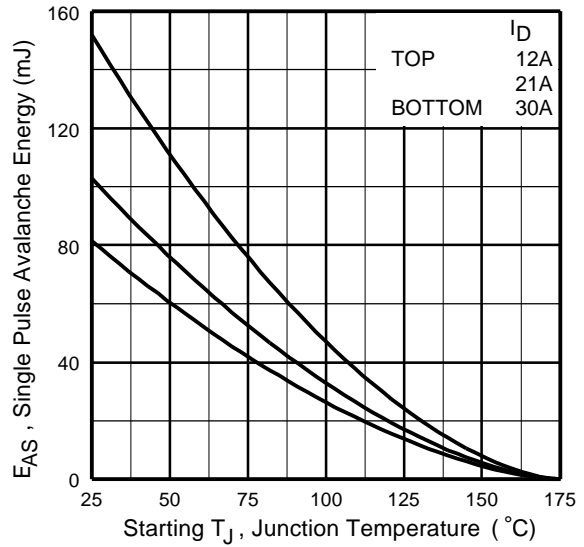
**Fig 12a.** Unclamped Inductive Test Circuit



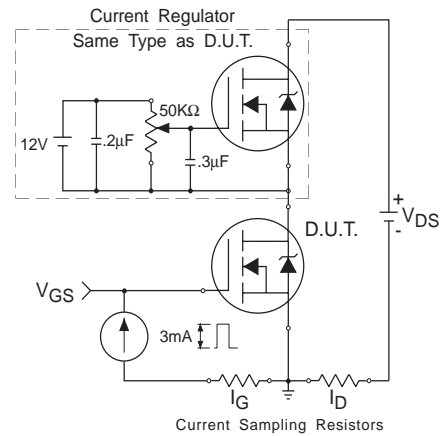
**Fig 12b.** Unclamped Inductive Waveforms



**Fig 13a.** Basic Gate Charge Waveform

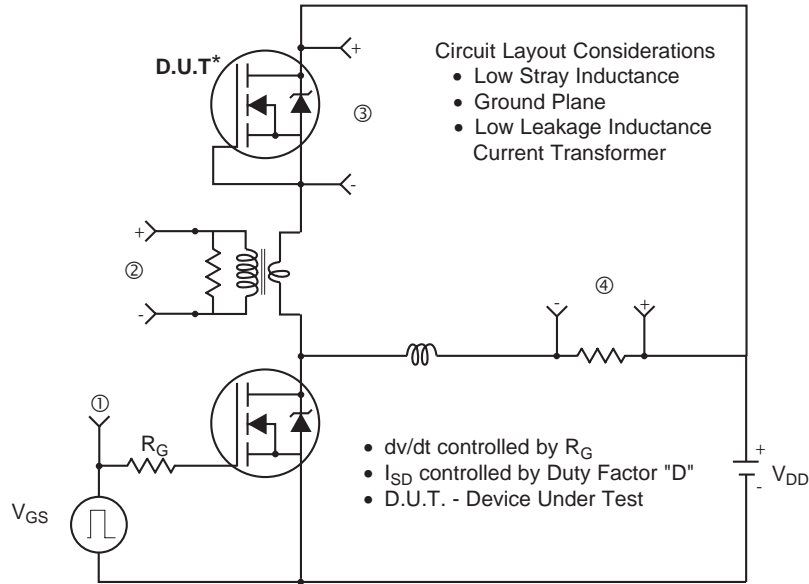


**Fig 12c.** Maximum Avalanche Energy Vs. Drain Current

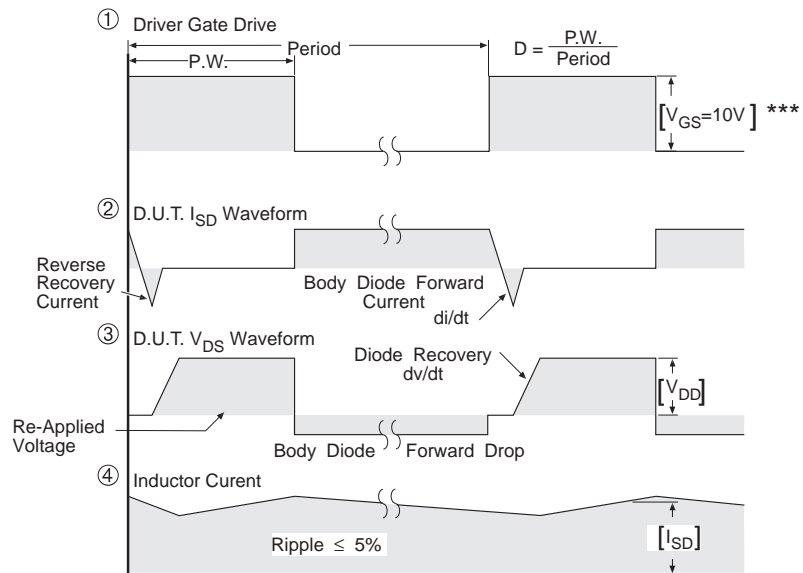


**Fig 13b.** Gate Charge Test Circuit

**Peak Diode Recovery dv/dt Test Circuit**



\* Reverse Polarity of D.U.T for P-Channel



\*\*\*  $V_{GS} = 5.0V$  for Logic Level and 3V Drive Devices

**Fig 14.** For N-channel HEXFET® power MOSFETs

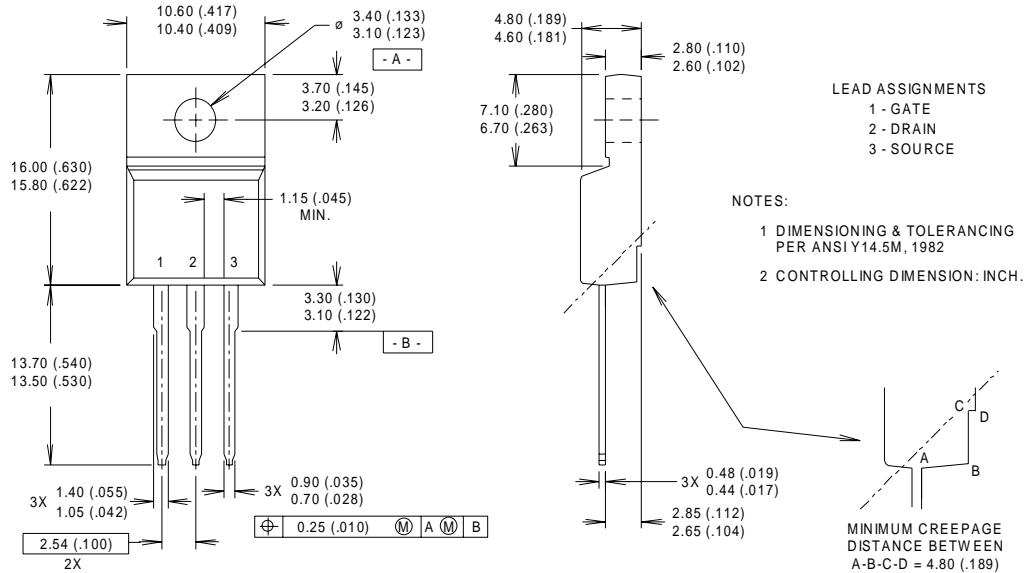
# IRFIZ34V

International  
**IR** Rectifier

## Package Outline

TO-220 Full-pak

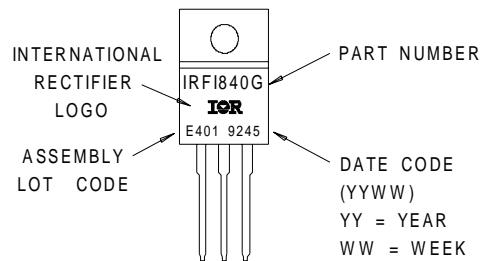
Dimensions are shown in millimeters (inches)



## Part Marking Information

TO-220 Full-pak

EXAMPLE : THIS IS AN IRFI840G  
 WITH ASSEMBLY  
 LOT CODE E401



Data and specifications subject to change without notice.  
 This product has been designed and qualified for the industrial market.  
 Qualification Standards can be found on IR's Web site.

International  
**IR** Rectifier

IR WORLD HEADQUARTERS: 233 Kansas St., El Segundo, California 90245, USA Tel: (310) 252-7105  
 TAC Fax: (310) 252-7903

Visit us at [www.irf.com](http://www.irf.com) for sales contact information.12/00

[www.irf.com](http://www.irf.com)