

Applications

- Zero Voltage Switching SMPS
- Telecom and Server Power Supplies
- Uninterruptible Power Supplies
- Motor Control applications

V _{DSS}	R _{DS(on) typ.}	T _{rr typ.}	I _D
600V	270mΩ	160ns	21A

Features and Benefits

- SuperFast body diode eliminates the need for external diodes in ZVS applications.
- Lower Gate charge results in simpler drive requirements.
- Enhanced dv/dt capabilities offer improved ruggedness.
- Higher Gate voltage threshold offers improved noise immunity.

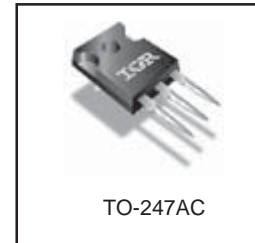

Absolute Maximum Ratings

	Parameter	Max.	Units
I _D @ T _C = 25°C	Continuous Drain Current, V _{GS} @ 10V	21	A
I _D @ T _C = 100°C	Continuous Drain Current, V _{GS} @ 10V	13	
I _{DM}	Pulsed Drain Current ①	84	
P _D @ T _C = 25°C	Power Dissipation	330	W
	Linear Derating Factor	2.6	W/°C
V _{GS}	Gate-to-Source Voltage	±30	V
dv/dt	Peak Diode Recovery dv/dt ②	11	V/ns
T _J	Operating Junction and	-55 to + 150	°C
T _{STG}	Storage Temperature Range		
	Soldering Temperature, for 10 seconds		
	Mounting torque, 6-32 or M3 screw	1.1(10)	N•m (lb•in)

Diode Characteristics

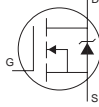
Symbol	Parameter	Min.	Typ.	Max.	Units	Conditions
I _S	Continuous Source Current (Body Diode)	—	—	21	A	MOSFET symbol showing the integral reverse p-n junction diode. 
I _{SM}	Pulsed Source Current (Body Diode) ①	—	—	84		
V _{SD}	Diode Forward Voltage	—	—	1.5	V	
t _{rr}	Reverse Recovery Time	—	160	240	ns	T _J = 25°C, I _F = 21A
		—	400	610		T _J = 125°C, di/dt = 100A/μs ④
Q _{rr}	Reverse Recovery Charge	—	480	730	nC	T _J = 25°C, I _S = 21A, V _{GS} = 0V ④
		—	1540	2310		T _J = 125°C, di/dt = 100A/μs ④
I _{RRM}	Reverse Recovery Current	—	5.3	7.9	A	T _J = 25°C
t _{on}	Forward Turn-On Time	Intrinsic turn-on time is negligible (turn-on is dominated by LS+LD)				

IRFP21N60L

International
IR Rectifier

Static @ $T_J = 25^\circ\text{C}$ (unless otherwise specified)

Symbol	Parameter	Min.	Typ.	Max.	Units	Conditions
$V_{(BR)DSS}$	Drain-to-Source Breakdown Voltage	600	—	—	V	$V_{GS} = 0V, I_D = 250\mu A$
$\Delta V_{(BR)DSS}/\Delta T_J$	Breakdown Voltage Temp. Coefficient	—	0.42	—	V/°C	Reference to $25^\circ\text{C}, I_D = 1mA$
$R_{DS(on)}$	Static Drain-to-Source On-Resistance	—	270	320	m Ω	$V_{GS} = 10V, I_D = 13A$ ④
$V_{GS(th)}$	Gate Threshold Voltage	3.0	—	5.0	V	$V_{DS} = V_{GS}, I_D = 250\mu A$
I_{DSS}	Drain-to-Source Leakage Current	—	—	50	μA	$V_{DS} = 600V, V_{GS} = 0V$
		—	—	2.0	mA	$V_{DS} = 480V, V_{GS} = 0V, T_J = 125^\circ\text{C}$
I_{GSS}	Gate-to-Source Forward Leakage	—	—	100	nA	$V_{GS} = 30V$
	Gate-to-Source Reverse Leakage	—	—	-100	nA	$V_{GS} = -30V$
R_G	Internal Gate Resistance	—	0.63	—	Ω	$f = 1MHz, \text{open drain}$

Dynamic @ $T_J = 25^\circ\text{C}$ (unless otherwise specified)

Symbol	Parameter	Min.	Typ.	Max.	Units	Conditions
g_{fs}	Forward Transconductance	11	—	—	S	$V_{DS} = 50V, I_D = 13A$
Q_g	Total Gate Charge	—	—	150	nC	$I_D = 21A$ $V_{DS} = 480V$ $V_{GS} = 10V, \text{See Fig. 7 \& 15 } \textcircled{4}$
Q_{gs}	Gate-to-Source Charge	—	—	46	nC	
Q_{gd}	Gate-to-Drain ("Miller") Charge	—	—	64	nC	
$t_{d(on)}$	Turn-On Delay Time	—	20	—	ns	$V_{DD} = 300V$ $I_D = 21A$ $R_G = 1.3\Omega$ $V_{GS} = 10V, \text{See Fig. 11a \& 11b } \textcircled{4}$
t_r	Rise Time	—	58	—	ns	
$t_{d(off)}$	Turn-Off Delay Time	—	33	—	ns	
t_f	Fall Time	—	10	—	ns	
C_{iss}	Input Capacitance	—	4000	—	pF	$V_{GS} = 0V$ $V_{DS} = 25V$ $f = 1.0MHz, \text{See Fig. 5}$ $V_{GS} = 0V, V_{DS} = 0V \text{ to } 480V \textcircled{5}$
C_{oss}	Output Capacitance	—	340	—	pF	
C_{rss}	Reverse Transfer Capacitance	—	29	—	pF	
$C_{oss \text{ eff.}}$	Effective Output Capacitance	—	170	—	pF	
$C_{oss \text{ eff. (ER)}}$	Effective Output Capacitance (Energy Related)	—	130	—	pF	

Avalanche Characteristics

Symbol	Parameter	Typ.	Max.	Units
E_{AS}	Single Pulse Avalanche Energy ②	—	420	mJ
I_{AR}	Avalanche Current ①	—	21	A
E_{AR}	Repetitive Avalanche Energy ①	—	33	mJ

Thermal Resistance

Symbol	Parameter	Typ.	Max.	Units
$R_{\theta JC}$	Junction-to-Case	—	0.38	°C/W
$R_{\theta CS}$	Case-to-Sink, Flat, Greased Surface	0.24	—	
$R_{\theta JA}$	Junction-to-Ambient	—	40	

Notes:

- ① Repetitive rating; pulse width limited by max. junction temperature. (See Fig. 11)
- ② Starting $T_J = 25^\circ\text{C}$, $L = 1.9mH$, $R_G = 25\Omega$, $I_{AS} = 21A$, $dv/dt = 11V/ns$. (See Figure 12a)
- ③ $I_{SD} \leq 21A$, $di/dt \leq 530A/\mu s$, $V_{DD} \leq V_{(BR)DSS}$, $T_J \leq 150^\circ\text{C}$.

④ Pulse width $\leq 300\mu s$; duty cycle $\leq 2\%$.

⑤ $C_{oss \text{ eff.}}$ is a fixed capacitance that gives the same charging time as C_{oss} while V_{DS} is rising from 0 to 80% V_{DSS} .
 $C_{oss \text{ eff. (ER)}}$ is a fixed capacitance that stores the same energy as C_{oss} while V_{DS} is rising from 0 to 80% V_{DSS} .

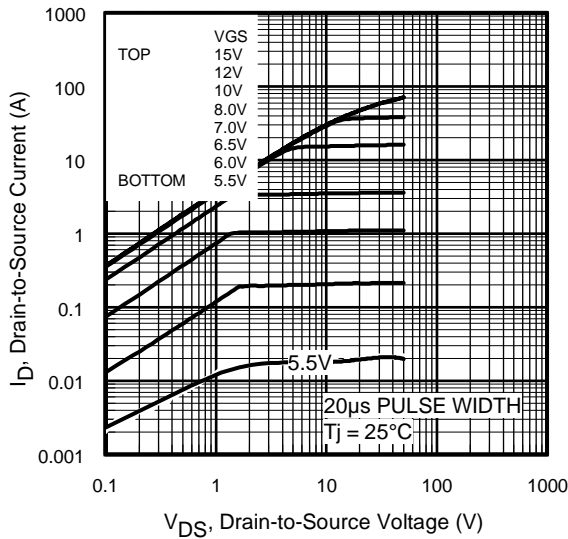

Fig 1. Typical Output Characteristics

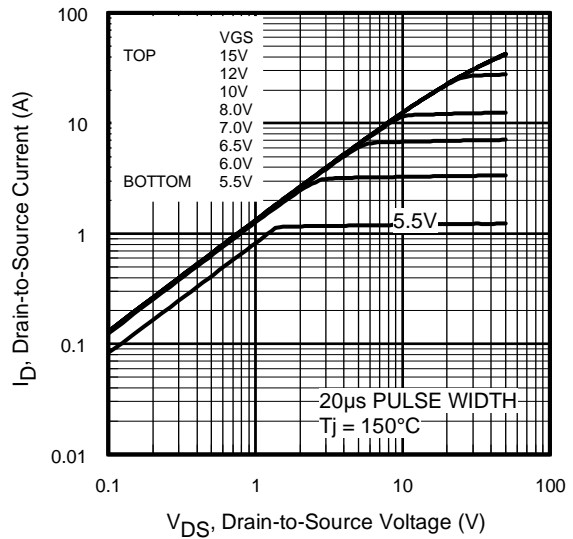

Fig 2. Typical Output Characteristics

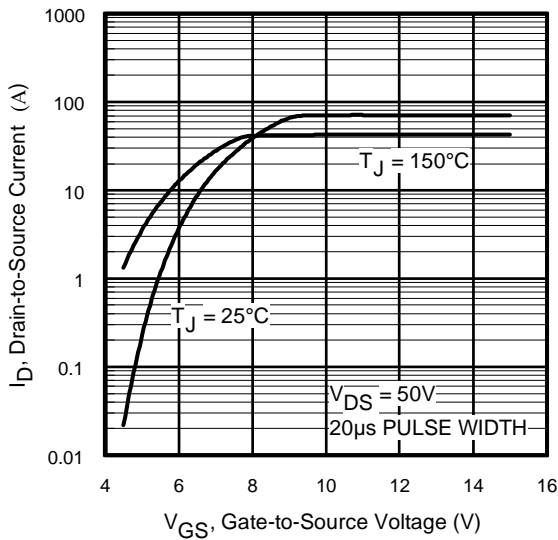

Fig 3. Typical Transfer Characteristics

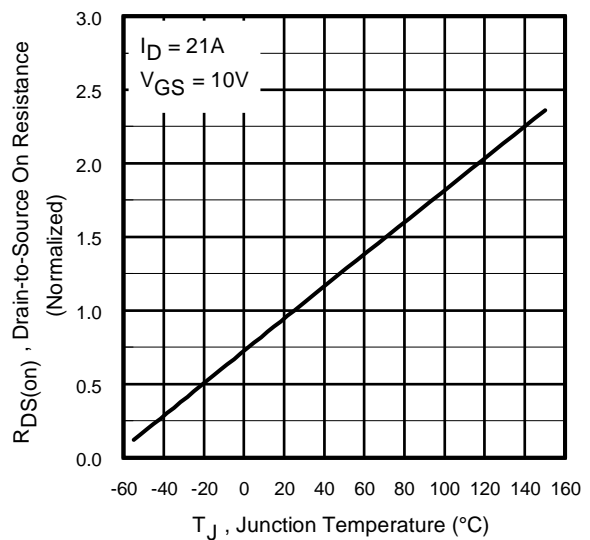

Fig 4. Normalized On-Resistance vs. Temperature

IRFP21N60L

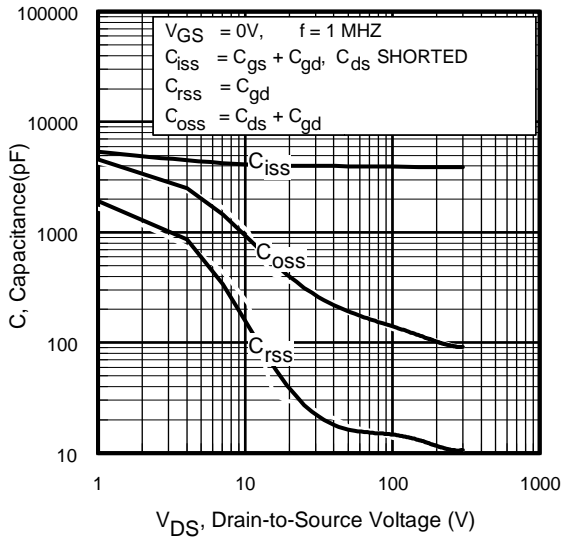

Fig 5. Typical Capacitance vs. Drain-to-Source Voltage

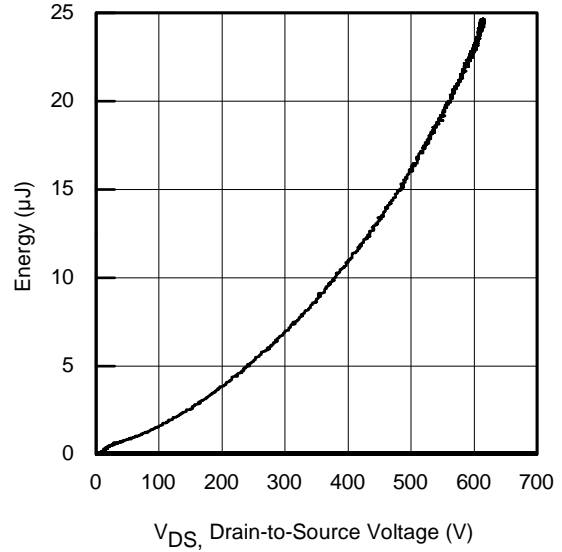

Fig 6. Typ. Output Capacitance Stored Energy vs. V_{DS}

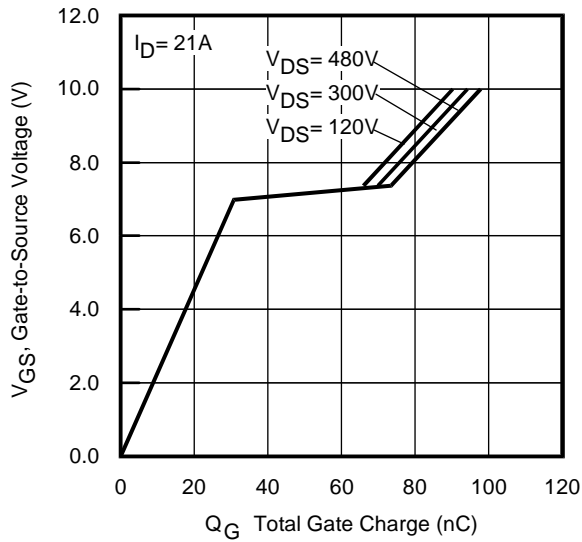

Fig 7. Typical Gate Charge vs. Gate-to-Source Voltage

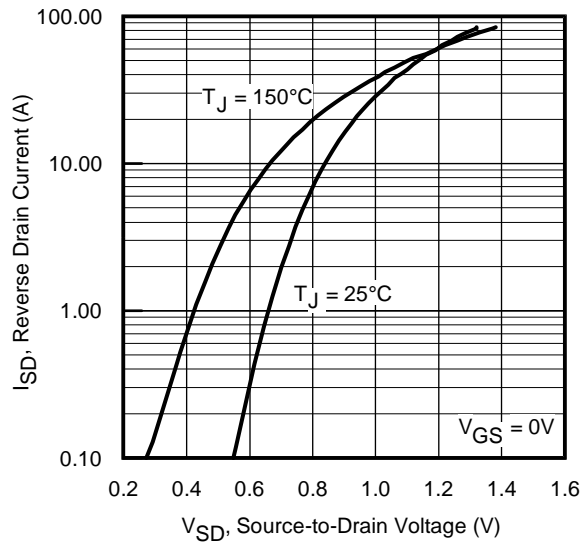

Fig 8. Typical Source-Drain Diode Forward Voltage

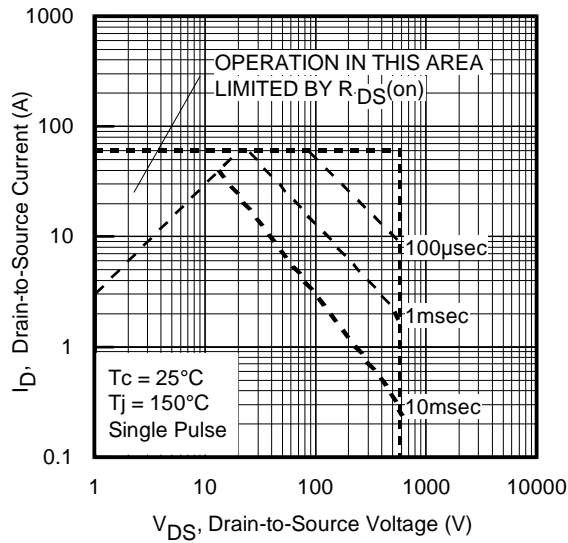

Fig 9. Maximum Safe Operating Area

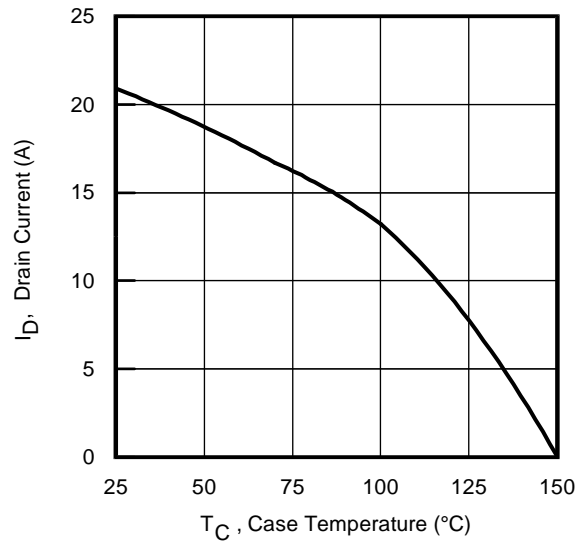

Fig 10. Maximum Drain Current vs. Case Temperature

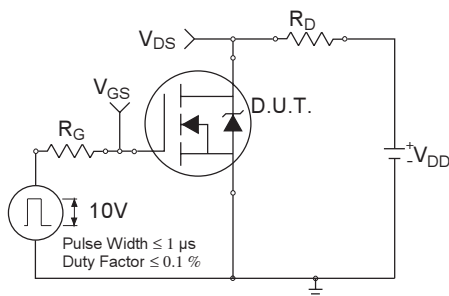

Fig 11a. Switching Time Test Circuit

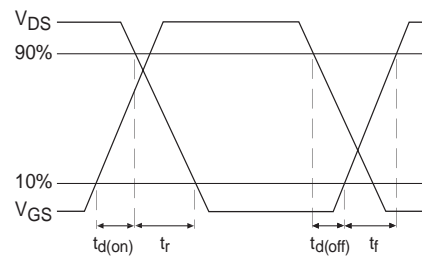

Fig 11b. Switching Time Waveforms

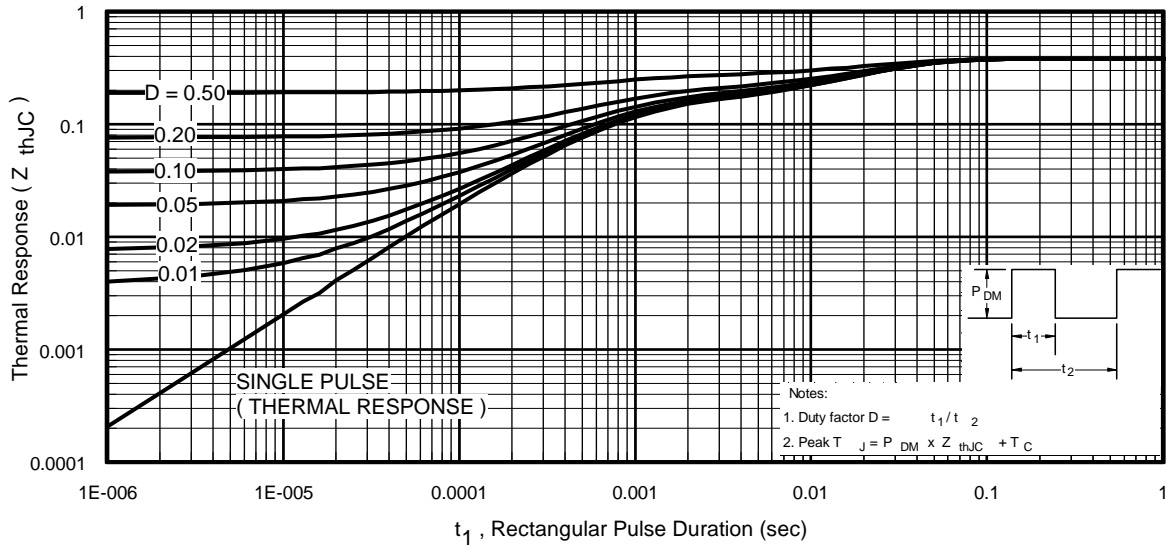

Fig 12. Maximum Effective Transient Thermal Impedance, Junction-to-Case

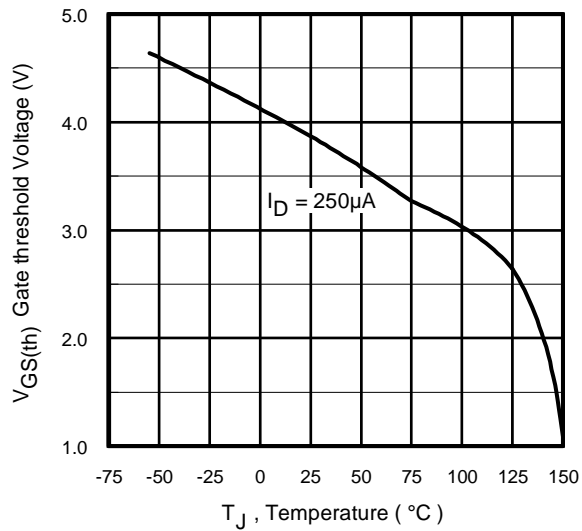

Fig 13. Threshold Voltage vs. Temperature

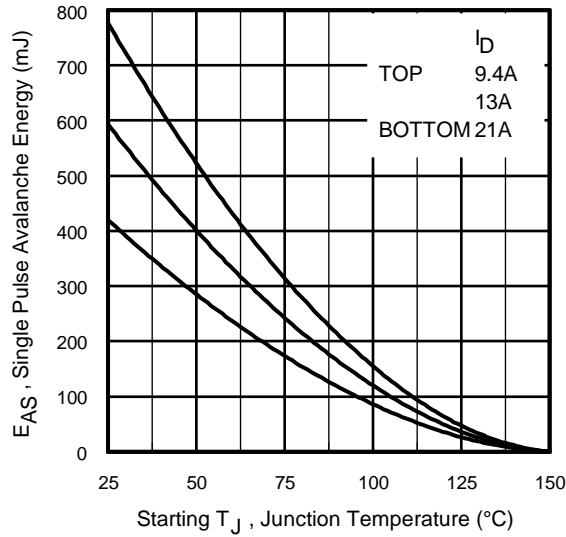

Fig 14a. Maximum Avalanche Energy vs. Drain Current

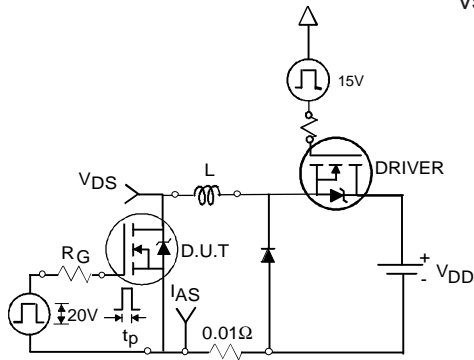

Fig 14b. Unclamped Inductive Test Circuit

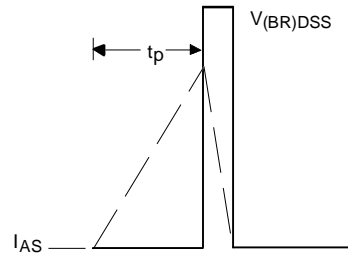

Fig 14c. Unclamped Inductive Waveforms

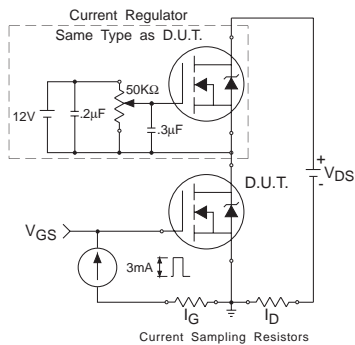

Fig 15a. Gate Charge Test Circuit

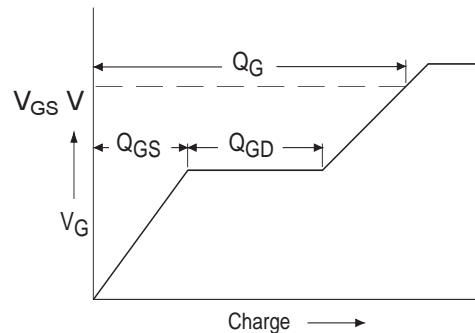
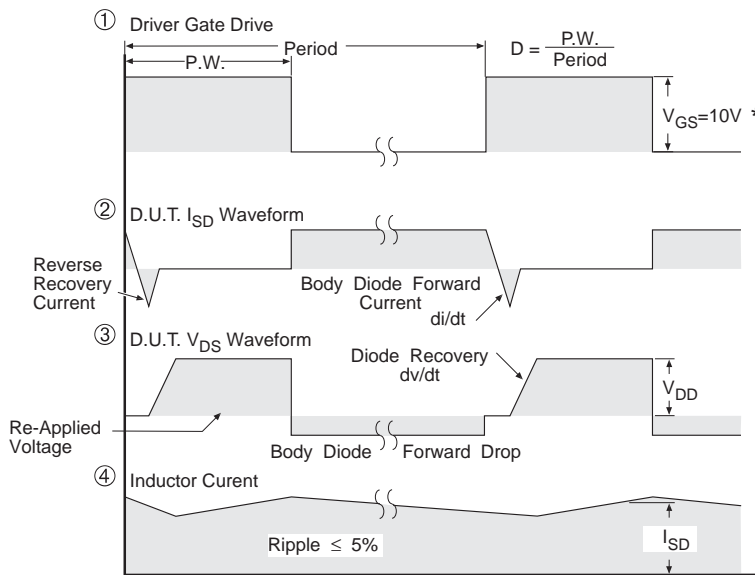
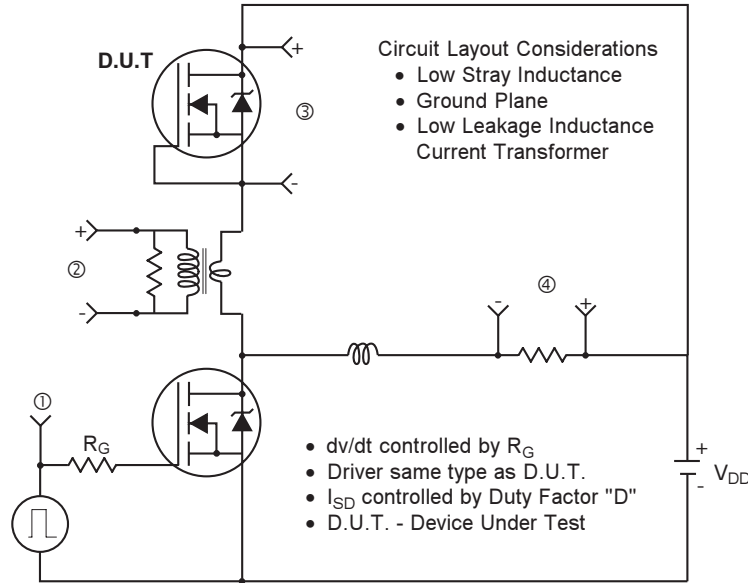

Fig 15b. Basic Gate Charge Waveform

Peak Diode Recovery dv/dt Test Circuit



* $V_{GS} = 5V$ for Logic Level Devices

Fig 16. For N-Channel HEXFET® Power MOSFETs

TO-247AC Package Outline

Dimensions are shown in millimeters (inches)

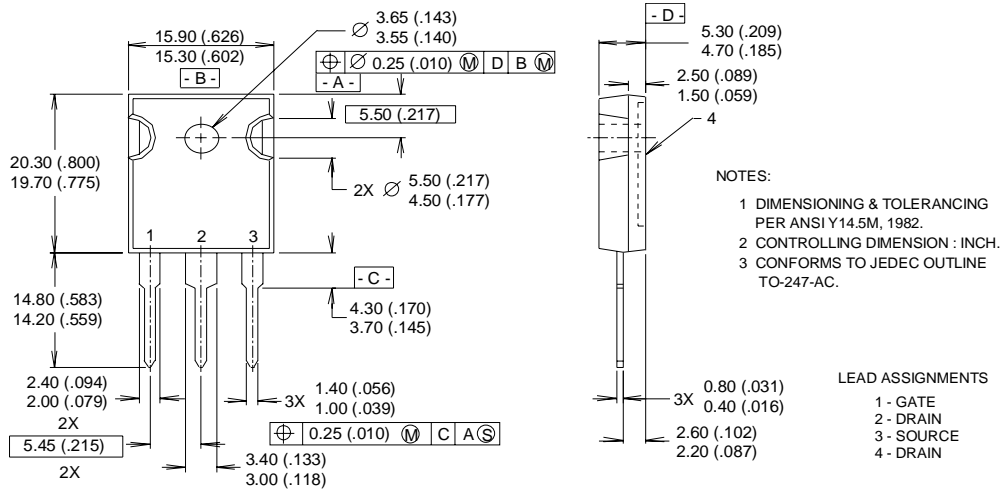

TO-247AC Part Marking Information

Notes: This part marking information applies to devices produced after 02/26/2001

EXAMPLE: THIS IS AN IRFPE30
 WITH ASSEMBLY
 LOT CODE 5657
 ASSEMBLED ON WW35, 2000
 IN THE ASSEMBLY LINE "H"

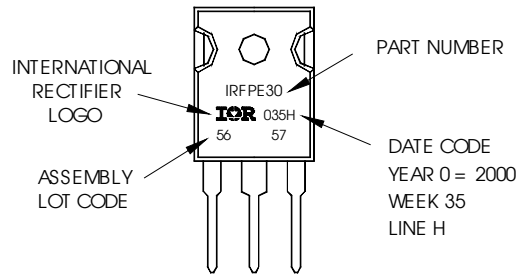

TO-247AC package is not recommended for Surface Mount Application.

Data and specifications subject to change without notice.
 This product has been designed and qualified for the Industrial market.
 Qualification Standards can be found on IR's Web site.