

# International IOR Rectifier

## MBRA140TR

### SCHOTTKY RECTIFIER

1.0 Amp

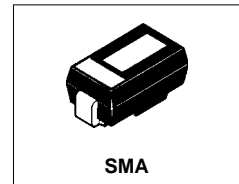

#### Major Ratings and Characteristics

Characteristics	MBRA140TR	Units
$I_{FAV}$ Rect. Waveform	1.0	A
$V_{RRM}$	40	V
$I_{FSM}$ @ $t_p = 5 \mu s$ sine	120	A
$V_F$ @ 1.0Apk, $T_J = 125^\circ C$	0.49	V
$T_J$ range	- 55 to 150	$^\circ C$

#### Description/ Features

The MBRA140TR surface mount Schottky rectifier has been designed for applications requiring low forward drop and very small foot prints on PC boards. Typical applications are in disk drives, switching power supplies, converters, free-wheeling diodes, battery charging, and reverse battery protection.

- Small foot print, surface mountable
- Low forward voltage drop
- High frequency operation
- Guard ring for enhanced ruggedness and long term reliability

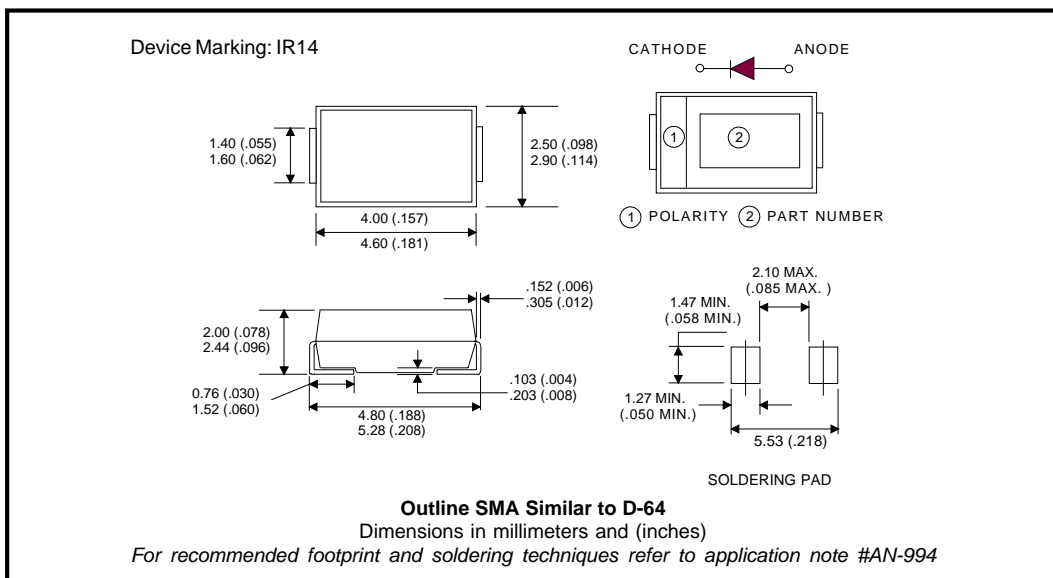

## Voltage Ratings

Part number	MBRA140TR
$V_R$ Max. DC Reverse Voltage (V)	40
$V_{RWM}$ Max. Working Peak Reverse Voltage (V)	

## Absolute Maximum Ratings

Parameters	Value	Units	Conditions
$I_{F(AV)}$ Max. Average Forward Current * See Fig. 4	1.0	A	50% duty cycle @ $T_L = 118^\circ\text{C}$ , rectangular wave form. On PC board 9mm <sup>2</sup> island (.013mm thick copper pad area)
$I_{FSM}$ Max. Peak One Cycle Non-Repetitive Surge Current * See Fig. 6	120	A	5 $\mu\text{s}$ Sine or 3 $\mu\text{s}$ Rect. pulse
	30		10ms Sine or 6ms Rect. pulse
$E_{AS}$ Non-Repetitive Avalanche Energy	3.0	mJ	$T_J = 25^\circ\text{C}$ , $I_{AS} = 1\text{A}$ , $L = 6\text{mH}$
$I_{AR}$ Repetitive Avalanche Current	1.0	A	

## Electrical Specifications

Parameters	Value	Units	Conditions
$V_{FM}$ Max. Forward Voltage Drop (1) * See Fig. 1	0.55	V	@ 1A
	0.71	V	@ 2A
	0.5	V	@ 1A
	0.65	V	@ 2A
	0.49	V	@ 1A
	0.63	V	@ 2A
$I_{RM}$ Max. Reverse Leakage Current (1) * See Fig. 2	0.5	mA	$T_J = 25^\circ\text{C}$
	10	mA	$T_J = 100^\circ\text{C}$
	26	mA	$T_J = 125^\circ\text{C}$
$V_{F(TO)}$ Threshold Voltage	0.36	V	$T_J = T_J \text{ max.}$
$r_t$ Forward Slope Resistance	104	m $\Omega$	
$C_T$ Typical Junction Capacitance	38	pF	$V_R = 10V_{DC}$ , $T_J = 25^\circ\text{C}$ , test signal = 1Mhz
$L_S$ Typical Series Inductance	2.0	nH	Measured lead to lead 5mm from package body
dv/dt Max. Voltage Rate of Change	10000	V/ $\mu\text{s}$	(Rated $V_R$ )

(1) Pulse Width < 300 $\mu\text{s}$ , Duty Cycle < 2%

Thermal-Mechanical Specifications

Parameters	Value	Units	Conditions
T <sub>J</sub> Max. Junction Temperature Range (*)	-55 to 150	°C	
T <sub>stg</sub> Max. Storage Temperature Range	-55 to 150	°C	
R <sub>thJL</sub> Max. Thermal Resistance Junction to Lead (**)	35	°C/W	DC operation (* See Fig. 4)
R <sub>thJA</sub> Max. Thermal Resistance Junction to Ambient	80	°C/W	DC operation
wt Approximate Weight	0.07(0.002)	g (oz.)	
Case Style	SMA		Similar D-64
Device Marking	IR14		

(\*)  $\frac{dP_{tot}}{dT_j} < \frac{1}{R_{th(j-a)}}$  thermal runaway condition for a diode on its own heatsink

(\*\*) Mounted 1 inch square PCB, Thermal Probe connected to lead 2mm from Package

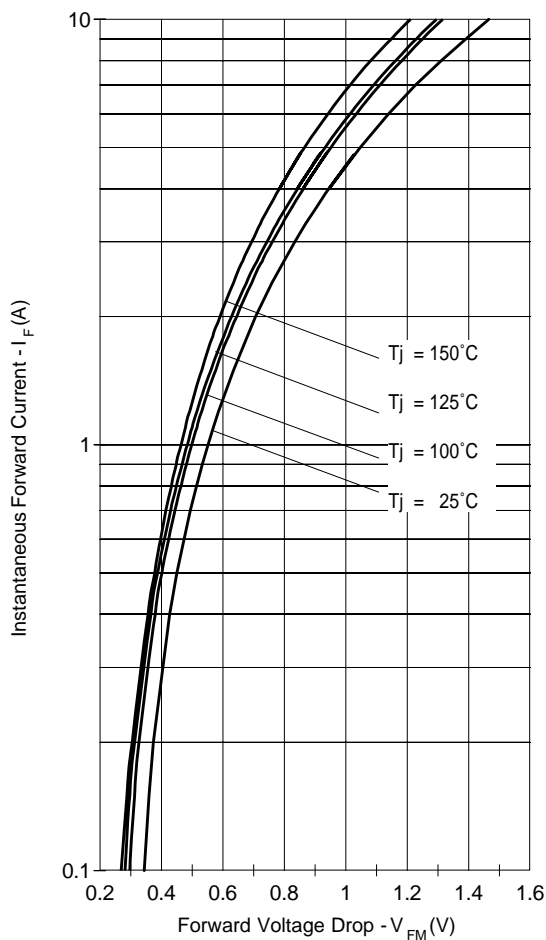

Fig. 1 - Maximum Forward Voltage Drop Characteristics

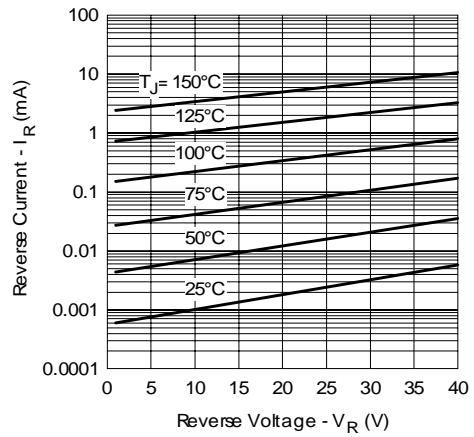

Fig. 2 - Typical Peak Reverse Current Vs. Reverse Voltage

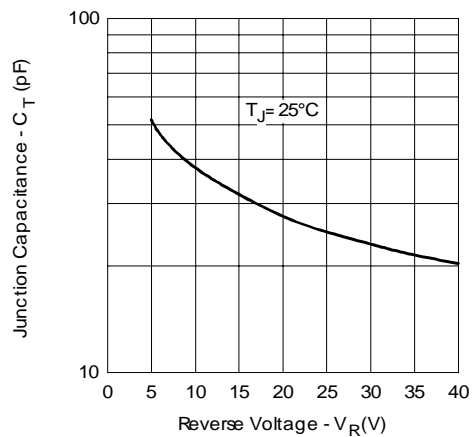

Fig. 3 - Typical Junction Capacitance Vs. Reverse Voltage

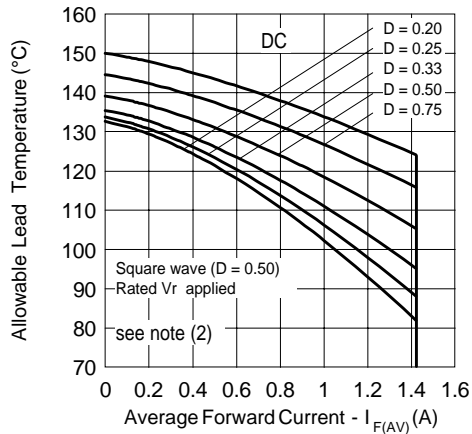

Fig. 4 - Maximum Average Forward Current Vs. Allowable Lead Temperature

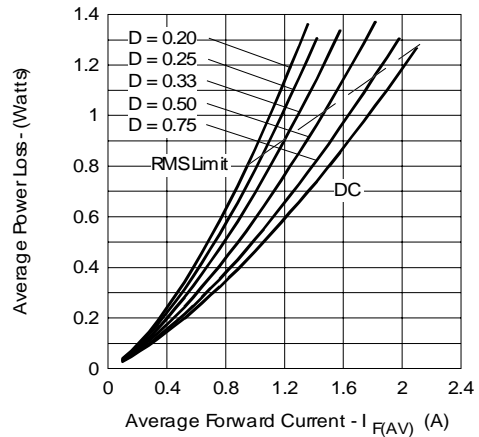

Fig. 5 - Maximum Average Forward Dissipation Vs. Average Forward Current

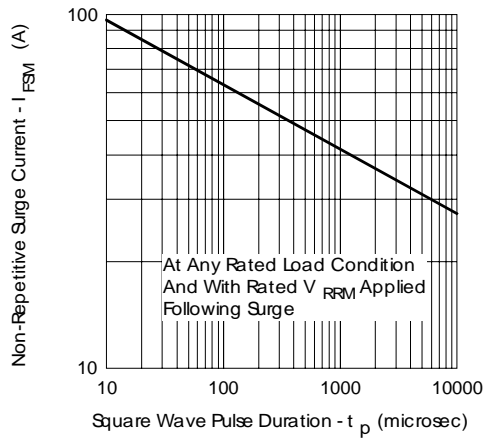

Fig. 6 - Maximum Peak Surge Forward Current Vs. Pulse Duration

(2) Formula used:  $T_c = T_j - (Pd + Pd_{REV}) \times R_{thJC}$ ;

$Pd = \text{Forward Power Loss} = I_{F(AV)} \times V_{FM} @ (I_{F(AV)} / D)$  (see Fig. 6);

$Pd_{REV} = \text{Inverse Power Loss} = V_{R1} \times I_R (1 - D)$ ;  $I_R @ V_{R1} = 80\% \text{ rated } V_R$

**Tape & Reel Information**

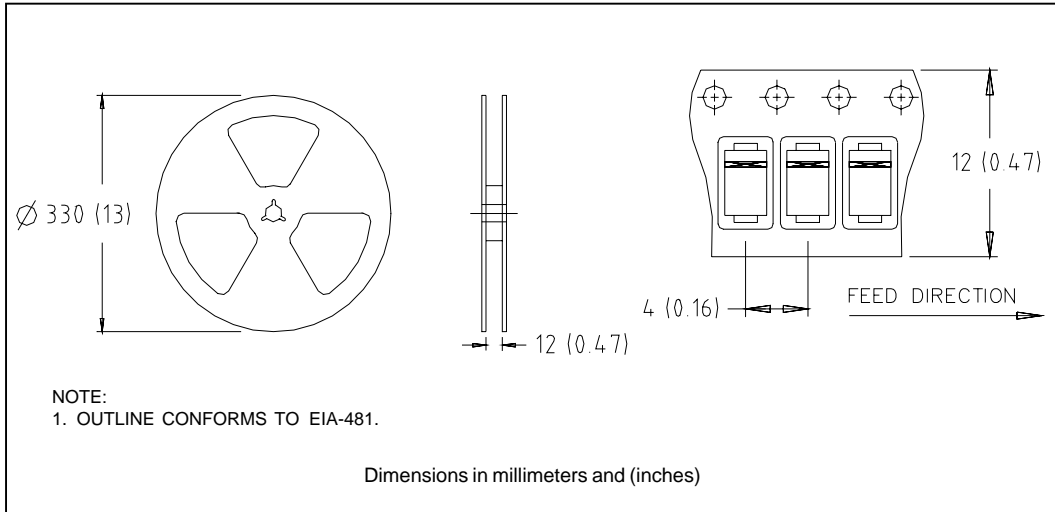

**Marking & Identification**

Each device has 2 rows for identification. The first row designates the device as manufactured by International Rectifier as indicated by the letters "IR", and the Part Number (indicates the current and the voltage rating). The second row indicates the year, the week of manufacturing and the Site ID.

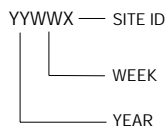
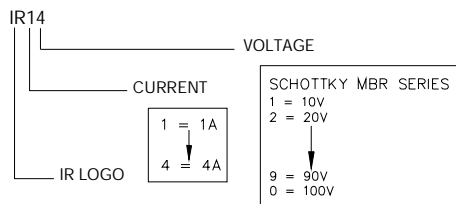

**Ordering Information**

**MBRA140TR - TAPE AND REEL**

WHEN ORDERING, INDICATE THE PART NUMBER AND THE QUANTITY ( IN MULTIPLES OF 7500 PIECES).

EXAMPLE: MBRA140TR - 15000 PIECES

MBRA140TR

Bulletin PD-20582 rev. C 03/03

International  
**IOR** Rectifier

Data and specifications subject to change without notice.  
This product has been designed and qualified for Industrial Level.  
Qualification Standards can be found on IR's Web site.

International  
**IOR** Rectifier

**IR WORLD HEADQUARTERS:** 233 Kansas St., El Segundo, California 90245, USA Tel: (310) 252-7105  
TAC Fax: (310) 252-7309

Visit us at [www.irf.com](http://www.irf.com) for sales contact information. 03/03