



# MBRD650CT MBRD660CT

SCHOTTKY RECTIFIER

6 Amp



### Major Ratings and Characteristics

Characteristics	MBRD650CT MBRD660CT	Units
$I_{F(AV)}$ Rectangular waveform	6	A
$V_{RRM}$	50 - 60	V
$I_{FSM}$ @ $t_p = 5 \mu s$ sine	490	A
$V_F$ @ 3 Apk, $T_J = 125^\circ C$ (per leg)	0.65	V
$T_J$ range	-40 to 150	$^\circ C$

### Description/ Features

The MBRD650CT, MBRD660CT surface mount, center tap, Schottky rectifier series has been designed for applications requiring low forward drop and small foot prints on PC board. Typical applications are in disk drives, switching power supplies, converters, free-wheeling diodes, battery charging, and reverse battery protection.

- Popular D-PAK outline
- Center tap configuration
- Small foot print, surface mountable
- Low forward voltage drop
- High frequency operation
- Guard ring for enhanced ruggedness and long term reliability

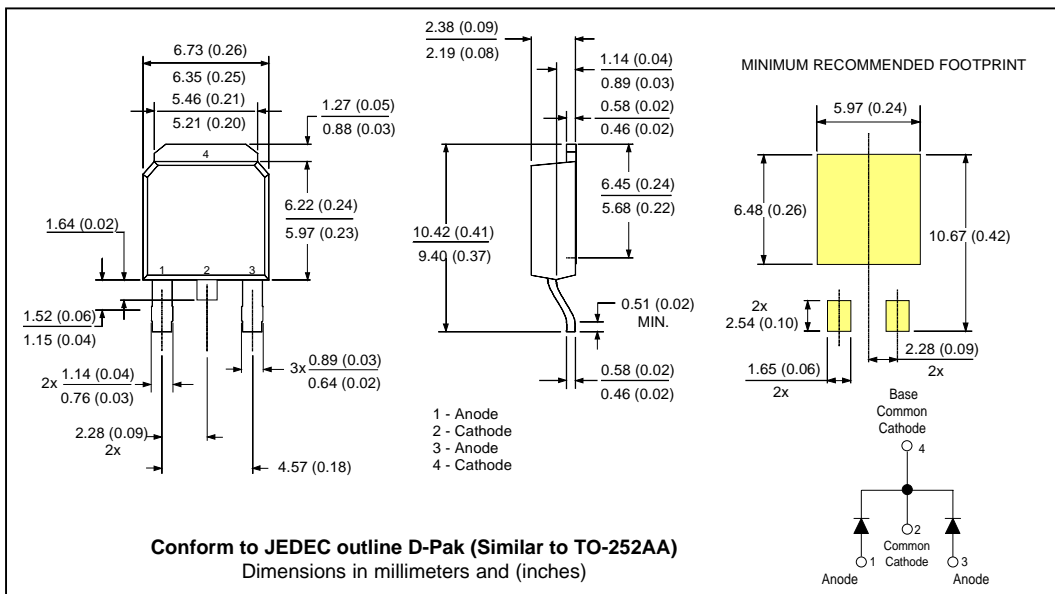

Voltage Ratings

Part number	MBRD650CT	MBRD660CT
V <sub>R</sub> Max. DC Reverse Voltage (V)	50	60
V <sub>RWM</sub> Max. Working Peak Reverse Voltage (V)		

Absolute Maximum Ratings

Parameters	Value	Units	Conditions
I <sub>F(AV)</sub> Max. Average Forward (Per Leg) Current * See Fig. 5 (Per Device)	3.0 6	A	50% duty cycle @ T <sub>C</sub> = 128°C, rectangular wave form
I <sub>FSM</sub> Max. Peak One Cycle Non-Repetitive Surge Current * See Fig. 7	490 75	A	5µs Sine or 3µs Rect. pulse 10ms Sine or 6ms Rect. pulse
E <sub>AS</sub> Non-Repet. Aval. Energy (Per Leg)	6	mJ	T <sub>J</sub> = 25 °C, I <sub>AS</sub> = 1 Amp, L = 12 mH
I <sub>AR</sub> Repetitive Avalanche Current (Per Leg)	0.6	A	Current decaying linearly to zero in 1 µsec Frequency limited by T <sub>J</sub> max. V <sub>A</sub> = 1.5 x V <sub>R</sub> typical

Electrical Specifications

Parameters	Value	Units	Conditions
V <sub>FM</sub> Max. Forward Voltage Drop (Per Leg) * See Fig. 1 (1)	0.7	V	@ 3A
	0.9	V	@ 6A
	0.65	V	@ 3A
	0.85	V	@ 6A
I <sub>RM</sub> Max. Reverse Leakage Current (Per Leg) * See Fig. 2 (1)	0.1	mA	T <sub>J</sub> = 25 °C
	15	mA	T <sub>J</sub> = 125 °C
C <sub>T</sub> Typ. Junction Capacitance (Per Leg)	145	pF	V <sub>R</sub> = 5V <sub>DC</sub> (test signal range 100Khz to 1Mhz) 25°C
L <sub>S</sub> Typical Series Inductance (Per Leg)	5.0	nH	Measured lead to lead 5mm from package body
dv/dt Max. Voltage Rate of Change	10000	V/µs	(Rated V <sub>R</sub> )

(1) Pulse Width < 300µs, Duty Cycle <2%

Thermal-Mechanical Specifications

Parameters	Value	Units	Conditions
T <sub>J</sub> Max. Junction Temperature Range (*)	-40 to 150	°C	
T <sub>stg</sub> Max. Storage Temperature Range	-40 to 150	°C	
R <sub>thJC</sub> Max. Thermal Resistance (Per Leg) Junction to Case (Per Device)	6 3	°C/W	DC operation * See Fig. 4
R <sub>thJA</sub> Max. Thermal Resistance Junction to Ambient	80	°C/W	
wt Approximate Weight	0.3 (0.01)	g (oz.)	
Case Style	D-Pak		Similar to TO-252AA

(\*)  $\frac{dP_{tot}}{dT_j} < \frac{1}{R_{th(j-a)}}$  thermal runaway condition for a diode on its own heatsink

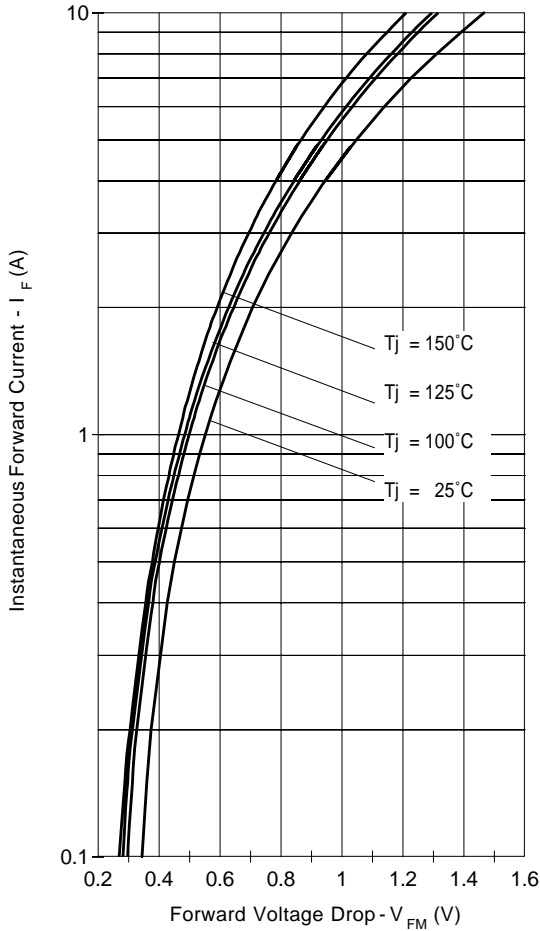

Fig. 1 - Max. Forward Voltage Drop Characteristics (Per Leg)

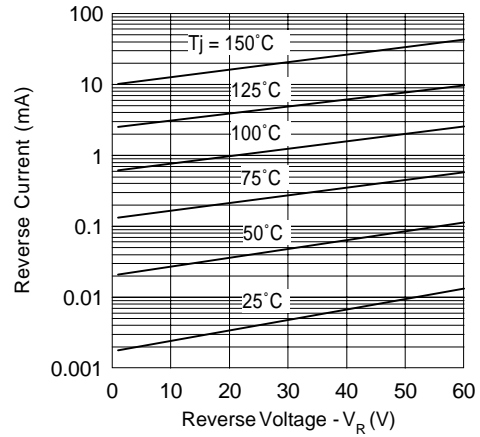

Fig. 2 - Typical Values Of Reverse Current Vs. Reverse Voltage (Per Leg)

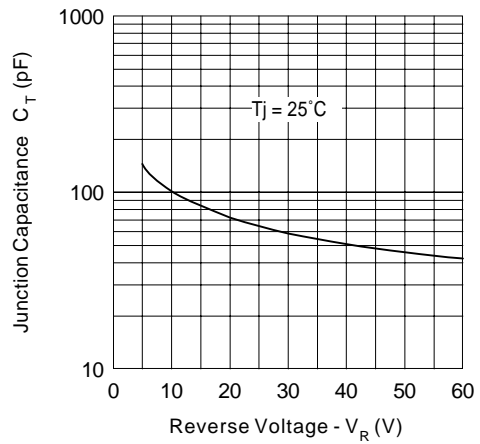

Fig. 3 - Typical Junction Capacitance Vs. Reverse Voltage (Per Leg)

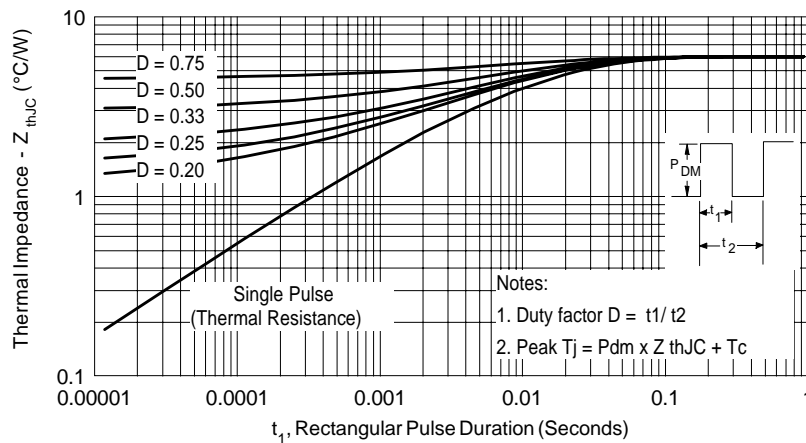

Fig. 4 - Max. Thermal Impedance  $Z_{thJC}$  Characteristics (Per Leg)

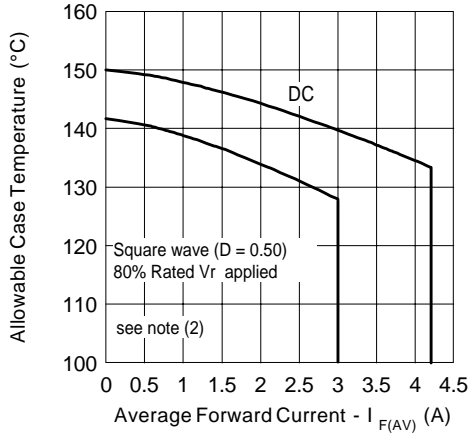

Fig. 5 - Max. Allowable Case Temperature Vs. Average Forward Current (Per Leg)

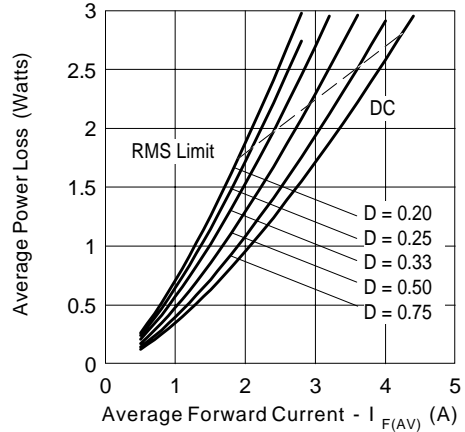

Fig. 6 - Forward Power Loss Characteristics (Per Leg)

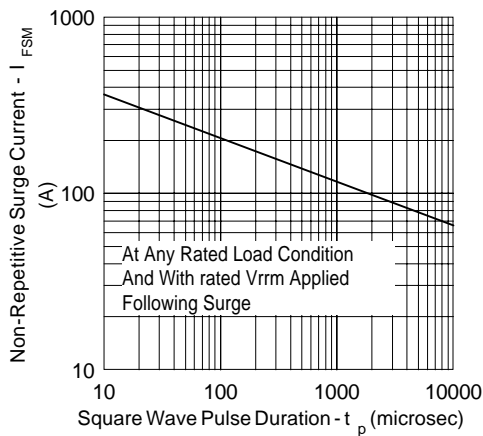
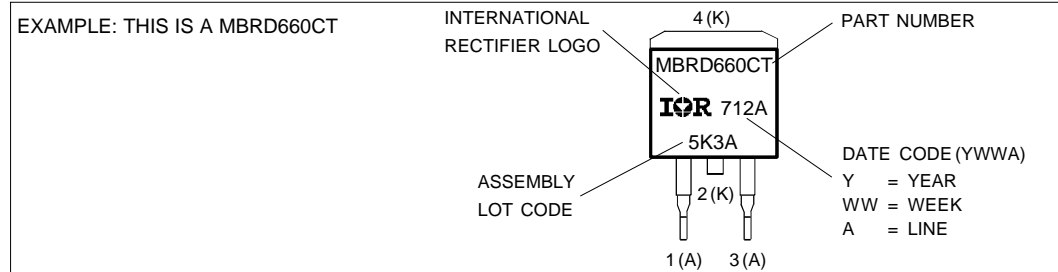

Fig. 7 - Max. Non-Repetitive Surge Current (Per Leg)

- (2) Formula used:  $T_C = T_J - (P_d + P_{d_{REV}}) \times R_{thJC}$ ;  
 $P_d = \text{Forward Power Loss} = I_{F(AV)} \times V_{FM} @ (I_{F(AV)} / D)$  (see Fig. 6);  
 $P_{d_{REV}} = \text{Inverse Power Loss} = V_{R1} \times I_R (1 - D)$ ;  $I_R @ V_{R1} = 80\% \text{ rated } V_R$

Marking Information



Tape & Reel Information

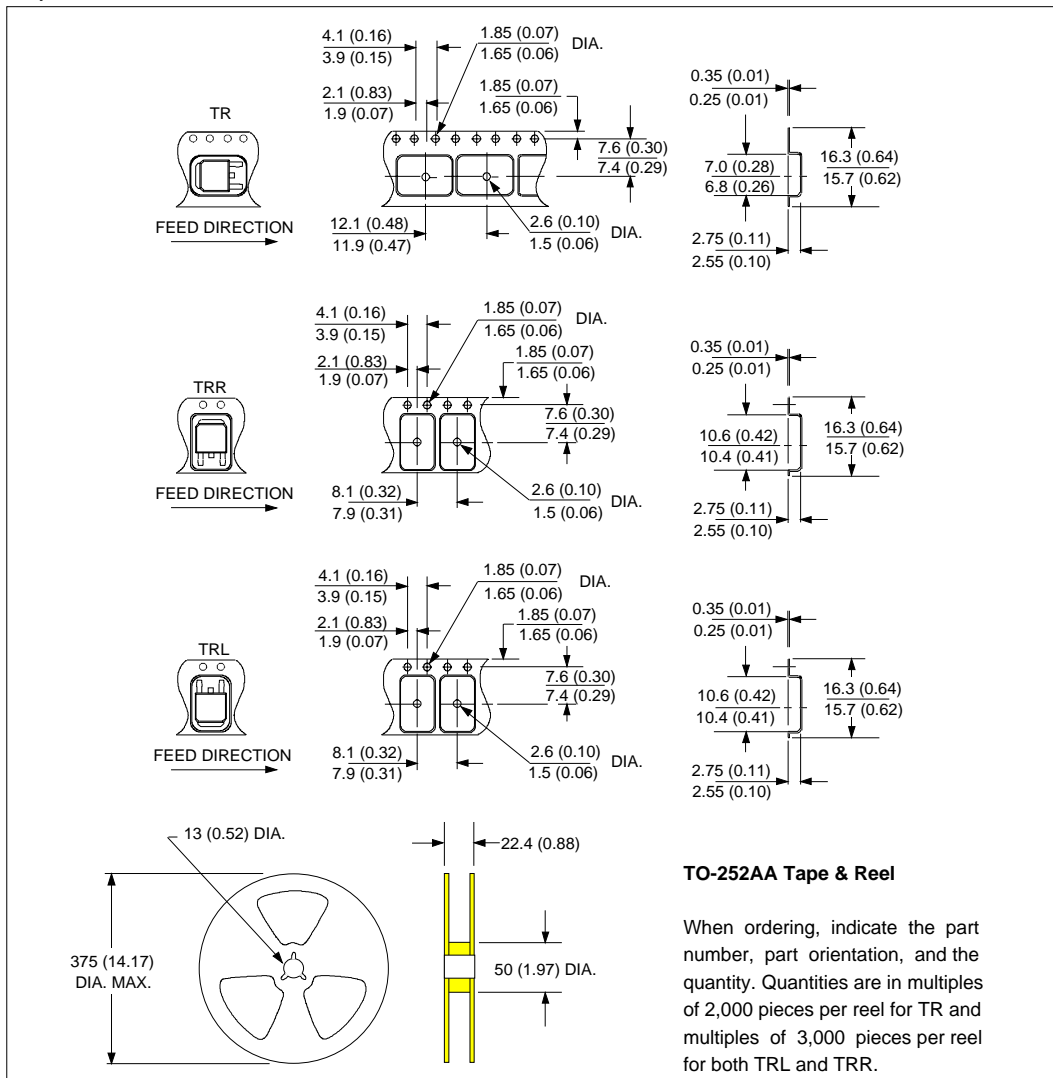

MBRD650CT, MBRD660CT

Bulletin PD-20755 rev. C 03/03

International  
**IOR** Rectifier

Data and specifications subject to change without notice.  
This product has been designed and qualified for Industrial Level.  
Qualification Standards can be found on IR's Web site.

International  
**IOR** Rectifier

**IR WORLD HEADQUARTERS:** 233 Kansas St., El Segundo, California 90245, USA Tel: (310) 252-7105  
TAC Fax: (310) 252-7309

Visit us at [www.irf.com](http://www.irf.com) for sales contact information. 03/03