

# International IOR Rectifier

## MBRS320

### SCHOTTKY RECTIFIER

3 Amp

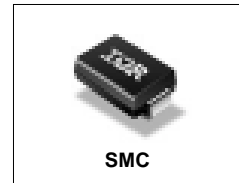

#### Major Ratings and Characteristics

Characteristics	MBRS320	Units
$I_{F(AV)}$ Rectangular waveform	3.0	A
$V_{RRM}$	20	V
$I_{FSM}$ @ $t_p=5\mu s$ sine	820	A
$V_F$ @ 3.0Apk, $T_J=125^\circ C$	0.36	V
$T_J$ range	- 65 to 150	$^\circ C$

#### Description/ Features

The MBRS320 surface-mount Schottky rectifier has been designed for applications requiring low forward drop and small foot prints on PC boards. Typical applications are in disk drives, switching power supplies, converters, free-wheeling diodes, battery charging, and reverse battery protection.

- Small foot print, surface mountable
- Very low forward voltage drop
- High frequency operation
- Guard ring for enhanced ruggedness and long term reliability

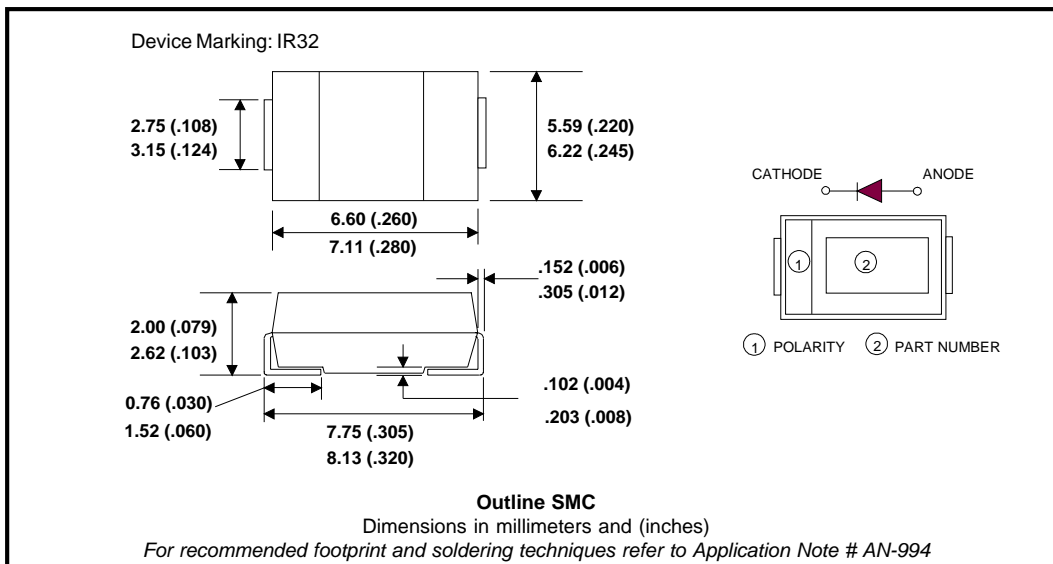

Voltage Ratings

Part number	MBRS320
V <sub>R</sub> Max. DC Reverse Voltage (V)	20
V <sub>RWM</sub> Max. Working Peak Reverse Voltage (V)	

Absolute Maximum Ratings

Parameters	Value	Units	Conditions
I <sub>F(AV)</sub> Max. Average Forward Current	3.0	A	50% duty cycle @ T <sub>L</sub> = 136°C, rectangular wave form
I <sub>FSM</sub> Max. Peak One Cycle Non-Repetitive Surge Current	820		5µs Sine or 3µs Rect. pulse
	80		10ms Sine or 6ms Rect. pulse
E <sub>AS</sub> Non Repetitive Avalanche Energy	4	mJ	T <sub>J</sub> = 25 °C, I <sub>AS</sub> = 1.0A, L = 8mH
I <sub>AR</sub> Repetitive Avalanche Current	1.0	A	Current decaying linearly to zero in 1 µsec Frequency limited by T <sub>J</sub> max. Va = 1.5 x Vr typical

Electrical Specifications

Parameters	Typ.	Max.	Units	Conditions
V <sub>FM</sub> Max. Forward Voltage Drop (1)	0.41	0.45	V	@ 3A
	0.45	0.53	V	@ 6A
	0.29	0.36	V	@ 3A
	0.35	0.46	V	@ 6A
I <sub>RM</sub> Max. Reverse Leakage Current (1)	0.04	0.5	mA	T <sub>J</sub> = 25 °C
	8.0	20	mA	T <sub>J</sub> = 100 °C
	23	35	mA	T <sub>J</sub> = 125 °C
C <sub>T</sub> Typical Junction Capacitance	360	-	pF	V <sub>R</sub> = 5V <sub>DC</sub> (test signal range 100kHz to 1Mhz), @ 25°C
L <sub>S</sub> Typical Series Inductance	3.0	-	nH	Measured lead to lead 5mm from package body
dv/dt Max. Voltage Rate of Change	-	10000	V/ µs	(Rated V <sub>R</sub> )

(1) Pulse Width < 300µs, Duty Cycle < 2%

Thermal-Mechanical Specifications

Parameters	Value	Units	Conditions
T <sub>J</sub> Max. Junction Temperature Range (*)	-65 to 150	°C	
T <sub>stg</sub> Max. Storage Temperature Range	-65 to 150	°C	
R <sub>thJL</sub> Max. Thermal Resistance Junction to Lead (**)	12	°C/W	DC operation
R <sub>thJA</sub> Max. Thermal Resistance Junction to Ambient	46	°C/W	
Wt Approximate Weight	0.24(0.008)	gr (oz)	
Case Style	SMC		Similar DO-214AB
Device Marking	IR32		

(\*)  $\frac{dP_{tot}}{dT_J} < \frac{1}{R_{th(j-a)}}$  thermal runaway condition for a diode on its own heatsink

(\*\*) Mounted 1 inch square PCB

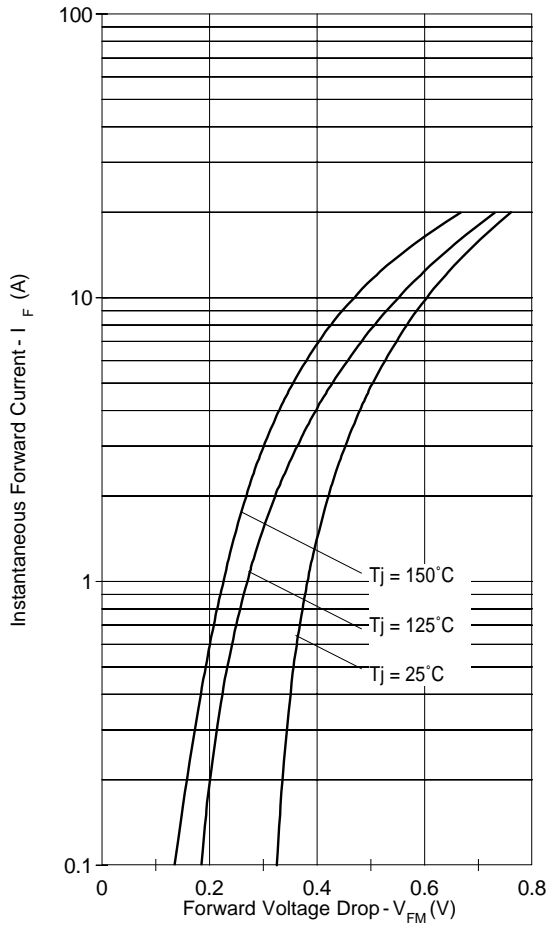

Fig. 1 - Max. Forward Voltage Drop Characteristics (Per Leg)

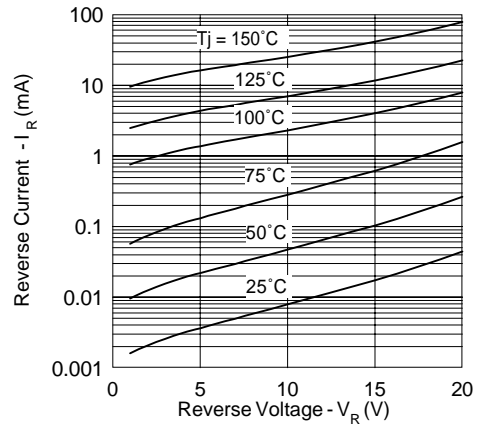

Fig. 2 - Typical Values Of Reverse Current Vs. Reverse Voltage (Per Leg)

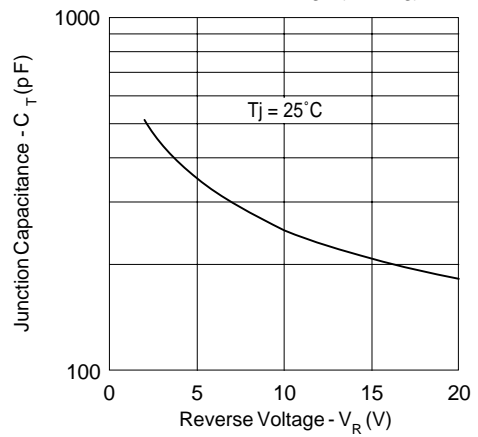

Fig. 3 - Typical Junction Capacitance Vs. Reverse Voltage (Per Leg)

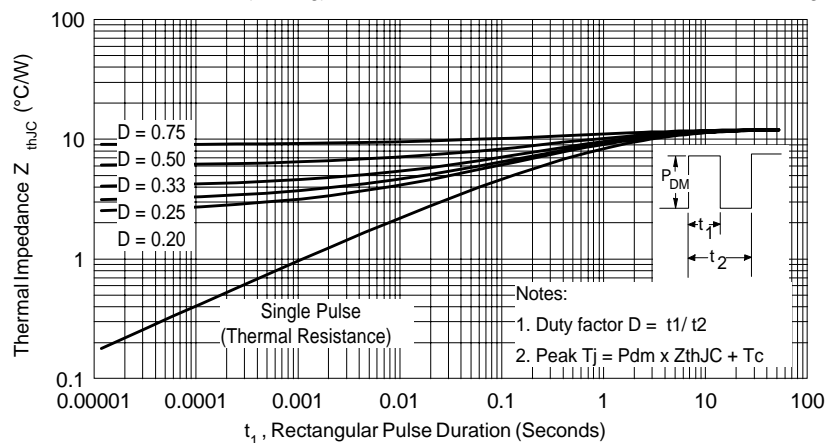

Fig. 4 - Max. Thermal Impedance  $Z_{thJC}$  Characteristics (Per Leg)

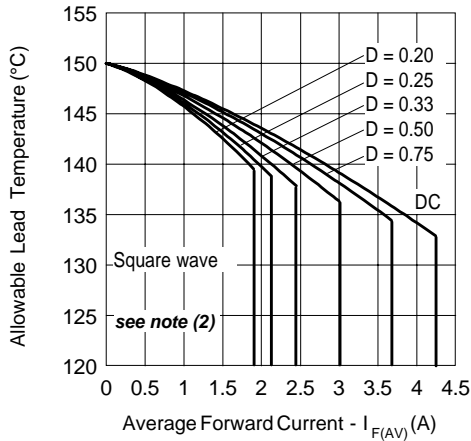

Fig. 5 - Maximum Average Forward Current Vs. Allowable Lead Temperature

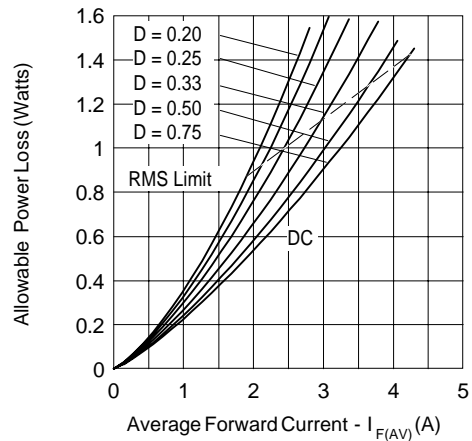

Fig. 6 - Maximum Average Forward Dissipation Vs. Average Forward Current

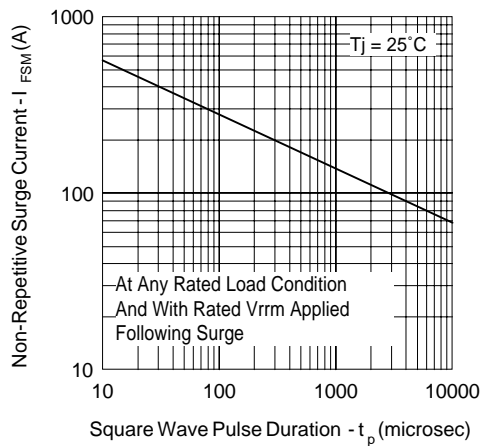
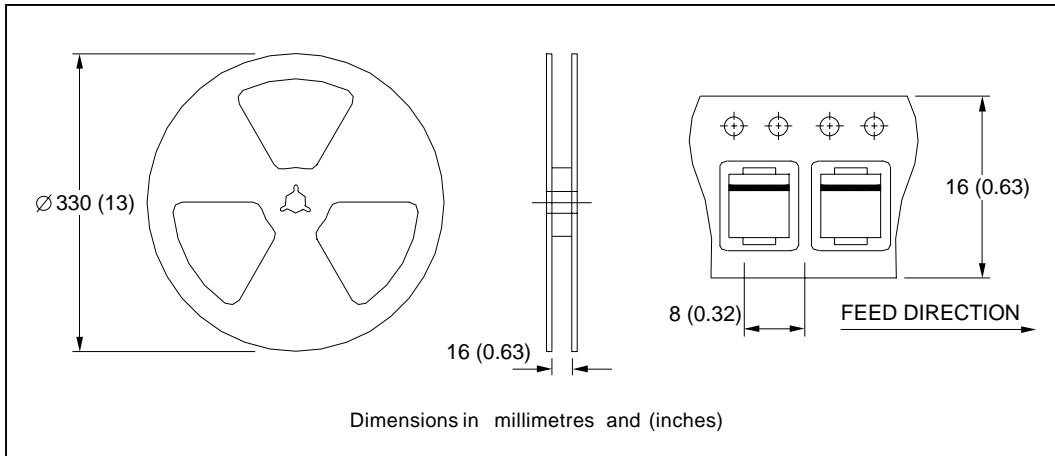

Fig. 7 - Maximum Peak Surge Forward Current Vs. Pulse Duration

- (2) Formula used:  $T_c = T_j - (Pd + Pd_{REV}) \times R_{thJC}$ ;  
 $Pd = \text{Forward Power Loss} = I_{F(AV)} \times V_{FM} @ (I_{F(AV)}/D)$  (see Fig. 6);  
 $Pd_{REV} = \text{Inverse Power Loss} = V_{R1} \times I_R (1 - D)$

**Tape & Reel Information**



**Marking & Identification**

**Ordering Information**

Each device has 2 rows for identification. The first row designates the device as manufactured by International Rectifier as indicated by the letters "IR", and the Part Number (indicates the current and the voltage rating). The second row indicates the year, the week of manufacturing and the Site ID.

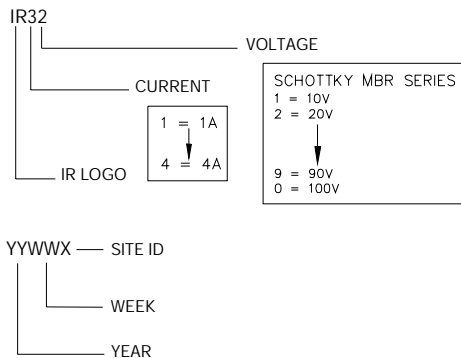
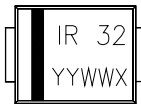

**MBRS320TR - TAPE AND REEL**

WHEN ORDERING, INDICATE THE PART NUMBER AND THE QUANTITY ( IN MULTIPLES OF 3000 PIECES).

EXAMPLE: MBRS320TR - 6000 PIECES

MBRS320

Bulletin PD-20645 rev. D 03/03

International  
**IOR** Rectifier

---

Data and specifications subject to change without notice.  
This product has been designed for Industrial Level.  
Qualification Standards can be found on IR's Web site.

International  
**IOR** Rectifier

**IR WORLD HEADQUARTERS:** 233 Kansas St., El Segundo, California 90245, USA Tel: (310) 252-7105  
TAC Fax: (310) 252-7309  
Visit us at [www.irf.com](http://www.irf.com) for sales contact information. 03/03