

SCHOTTKY RECTIFIER

20 Amps

Major Ratings and Characteristics

Characteristics	Values	Units
$I_{F(AV)}$ Rectangular waveform	20	A
V_{RRM}	15	V
I_{FSM} @tp = 5 μ s sine	700	A
V_F @19Apk, $T_J = 125^\circ\text{C}$ (Typical)	0.25	V
T_J range	-55 to 125	$^\circ\text{C}$

Description/Features

The Schottky rectifier module has been optimized for ultra low forward voltage drop specifically for the OR-ing of parallel power supplies. The proprietary barrier technology allows for reliable operation up to 125 $^\circ\text{C}$ junction temperature. Typical applications are in parallel switching power supplies, converters, reverse battery protection, and redundant power subsystems.

- 125 $^\circ\text{C}$ T_J operation ($V_R < 5\text{V}$)
- Center tap module
- Optimized for OR-ing applications
- Ultra low forward voltage drop
- High frequency operation
- Guard ring for enhanced ruggedness and long term reliability
- High purity, high temperature epoxy encapsulation for enhanced mechanical strength and moisture resistance

Case Styles

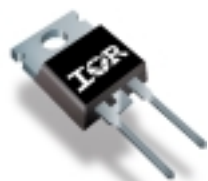
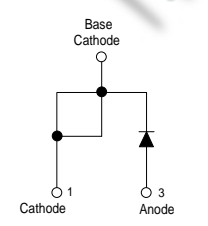
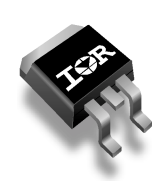
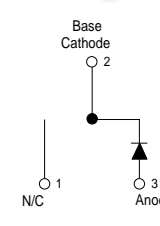
<p>STPS20L15D</p>   <p>TO-220AC</p>	<p>STPS20L15G</p>   <p>D²PAK</p>
---	---

STPS20L15D, STPS20L15G

Bulletin PD-20626 rev. B 09/01



Voltage Ratings

Part number	Values
V_R Max. DC Reverse Voltage (V) @ $T_J = 100^\circ\text{C}$	15
V_{RWM} Max. Working Peak Reverse Voltage (V) @ $T_J = 100^\circ\text{C}$	

Absolute Maximum Ratings

Parameters	Values	Units	Conditions
$I_{F(AV)}$ Max. Average Forward Current * See Fig. 5	20	A	50% duty cycle @ $T_C = 85^\circ\text{C}$, rectangular waveform
I_{FSM} Max. Peak One Cycle Non-Repetitive Surge Current * See Fig. 7	700	A	5 μs Sine or 3 μs Rect. pulse
	330		10ms Sine or 6ms Rect. pulse
E_{AS} Non-Repetitive Avalanche Energy	10	mJ	$T_J = 25^\circ\text{C}$, $I_{AS} = 2$ Amps, $L = 6$ mH
I_{AR} Repetitive Avalanche Current	2	A	Current decaying linearly to zero in 1 μsec Frequency limited by T_J max. $V_A = 1.5 \times V_R$ typical

Electrical Specifications

Parameters	Values		Units	Conditions	
	Typ.	Max.			
V_{FM} Forward Voltage Drop * See Fig. 1 (1)	-	0.41	V	@ 19A	$T_J = 25^\circ\text{C}$
	-	0.52	V	@ 40A	
	0.25	0.33	V	@ 19A	$T_J = 125^\circ\text{C}$
	0.37	0.50	V	@ 40A	
I_{RM} Reverse Leakage Current * See Fig. 2 (1)	-	10	mA	$T_J = 25^\circ\text{C}$	$V_R = \text{rated } V_R$
	-	600	mA	$T_J = 100^\circ\text{C}$	
$V_{F(TO)}$ Threshold Voltage	0.182		V	$T_J = T_J \text{ max.}$	
r_t Forward Slope Resistance	7.6		m Ω		
C_T Max. Junction Capacitance	-	2000	pF	$V_R = 5V_{DC}$, (test signal range 100Khz to 1Mhz) 25°C	
L_S Typical Series Inductance	8	-	nH	Measured lead to lead 5mm from package body	
dv/dt Max. Voltage Rate of Change	10000		V/ μs	(Rated V_R)	

(1) Pulse Width < 300 μs , Duty Cycle <2%

Thermal-Mechanical Specifications

Parameters	Values	Units	Conditions
T_J Max. Junction Temperature Range	-55 to 125	$^\circ\text{C}$	
T_{stg} Max. Storage Temperature Range	-55 to 150	$^\circ\text{C}$	
R_{thJC} Max. Thermal Resistance Junction to Case	1.5	$^\circ\text{C/W}$	DC operation * See Fig. 4
R_{thCS} Typical Thermal Resistance Case to Heatsink	0.50	$^\circ\text{C/W}$	Mounting surface, smooth and greased For TO-220
R_{thJA} Max. Thermal Resistance Junction to Ambient	40	$^\circ\text{C/W}$	DC operation For D ² Pak
wt Approximate Weight	2(0.07)	g(oz.)	
T Mounting Torque	Min.	6(5)	Kg-cm (lbf-in)
	Max.	12(10)	

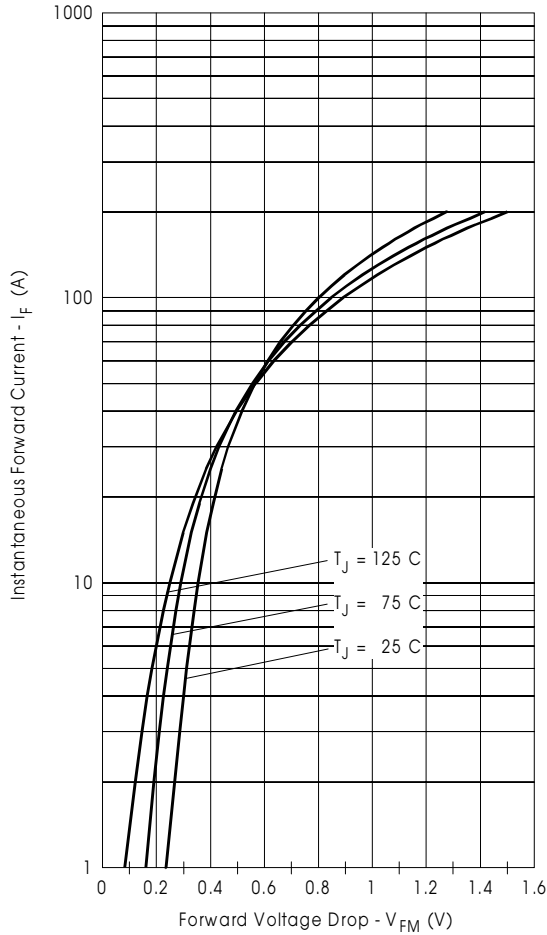

Fig. 1 - Maximum Forward Voltage Drop Characteristics

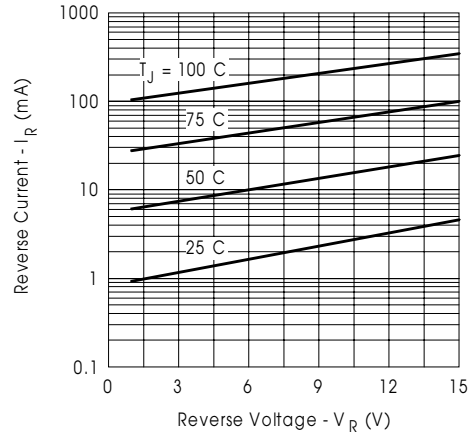

Fig. 2 - Typical Values of Reverse Current Vs. Reverse Voltage

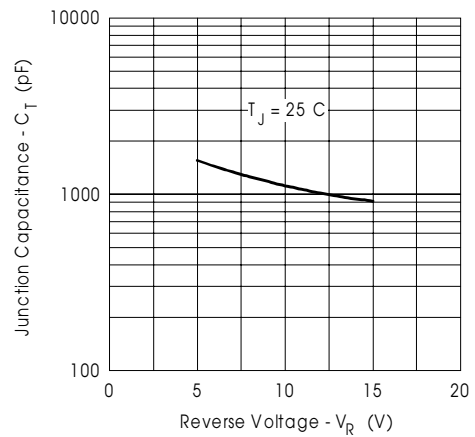

Fig. 3 - Typical Junction Capacitance Vs. Reverse Voltage

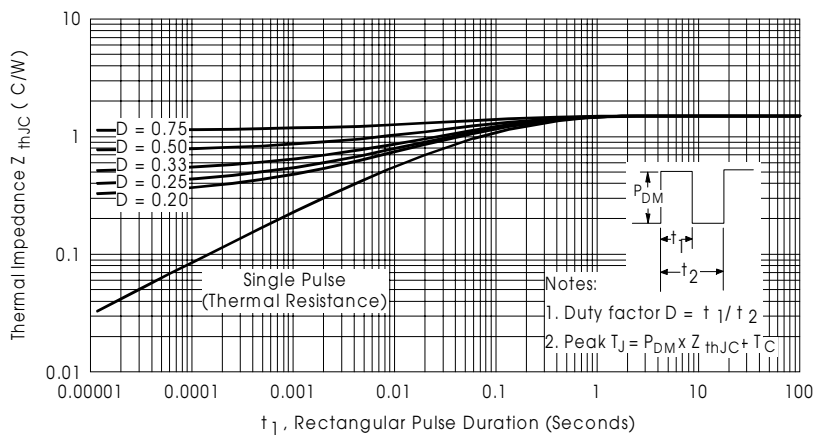

Fig. 4 - Maximum Thermal Impedance Z_{thJC} Characteristics

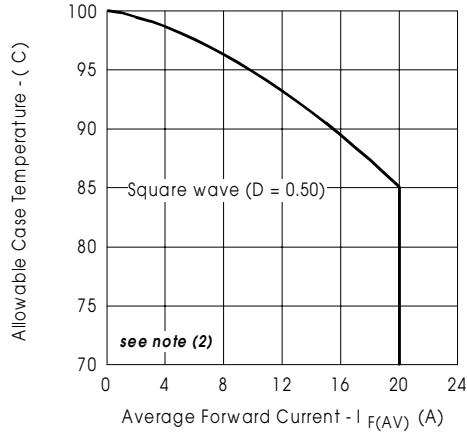

Fig. 5- Maximum Allowable Case Temperature Vs. Average Forward Current

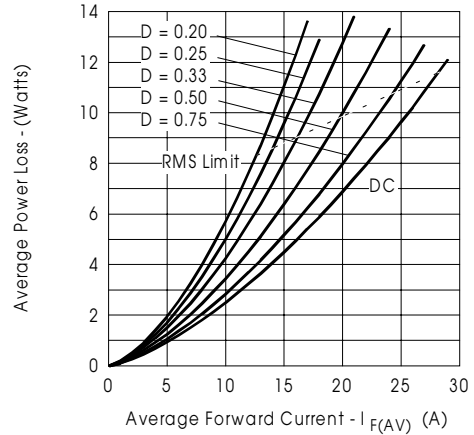

Fig. 6- Forward Power Loss Characteristics

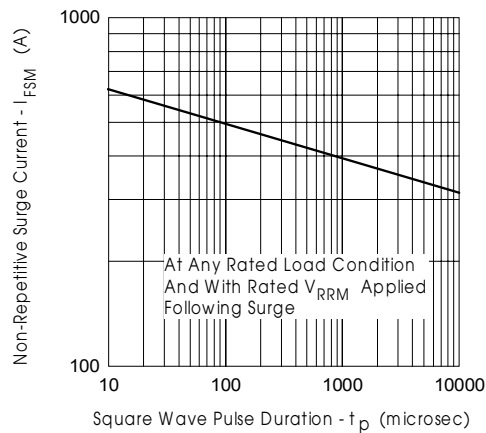

Fig. 7- Maximum Non-Repetitive Surge Current

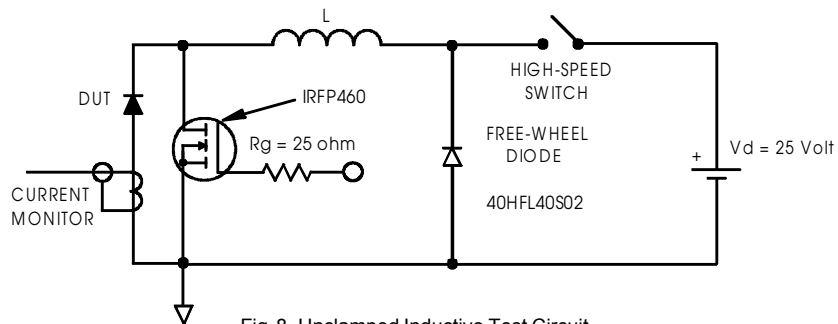
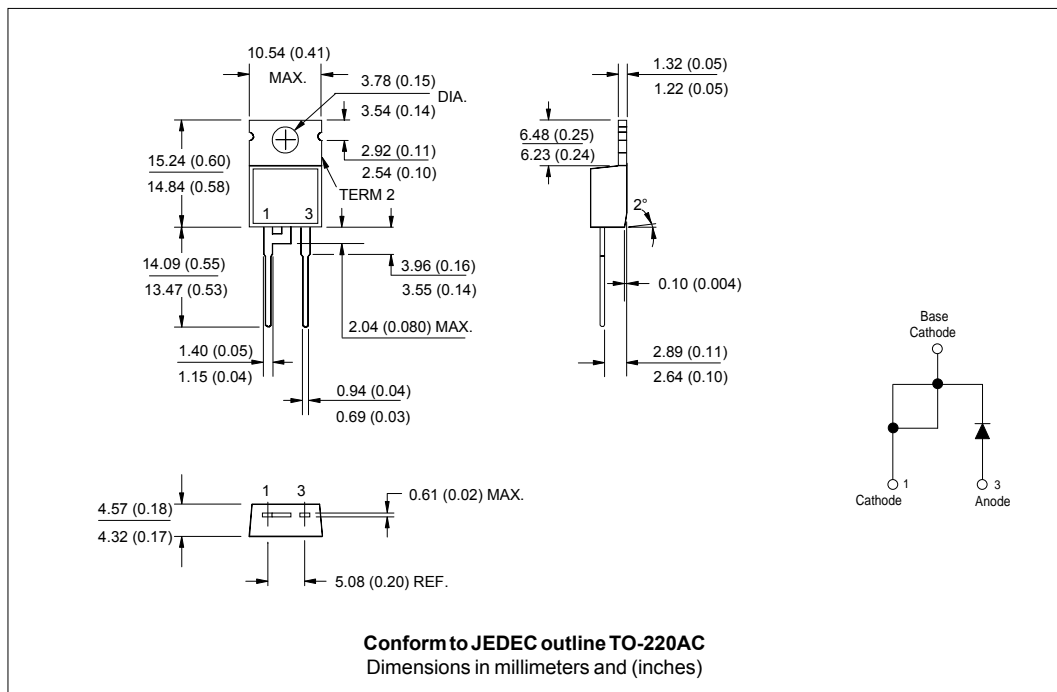
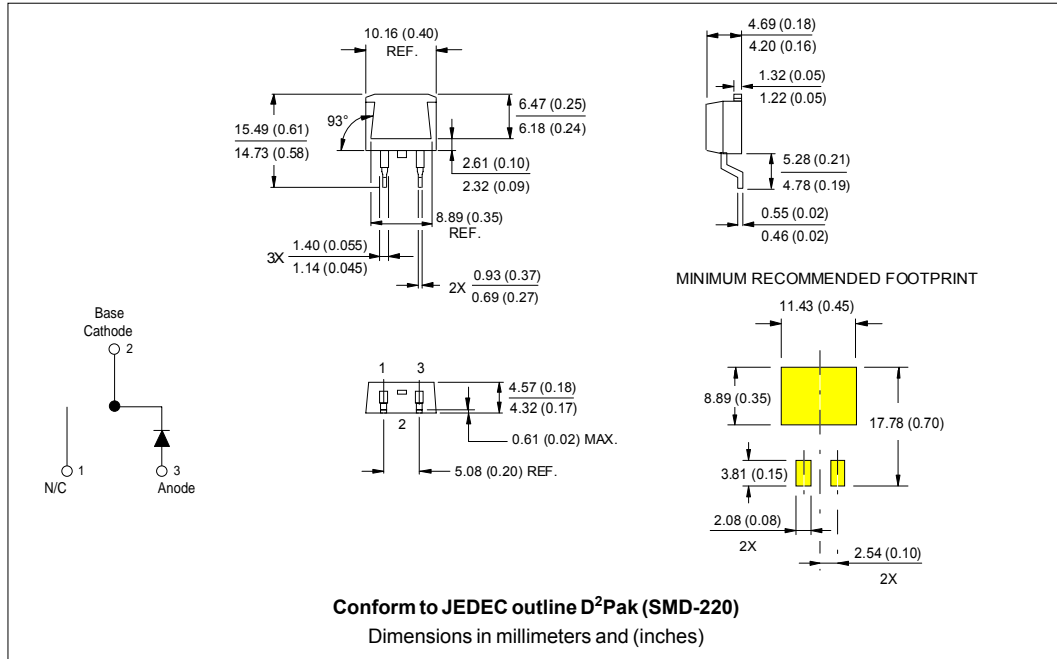

Fig. 8- Unclamped Inductive Test Circuit

- (2) Formula used: $T_c = T_j - (Pd + Pd_{REV}) \times R_{thJC}$;
 $Pd = \text{Forward Power Loss} = I_{F(AV)} \times V_{FM} @ (I_{F(AV)} / D)$ (see Fig. 6);
 $Pd_{REV} = \text{Inverse Power Loss} = V_{R1} \times I_R (1 - D)$; $I_R @ V_{R1} = 80\% \text{ rated } V_R$

Outline Table



Tape & Reel Information

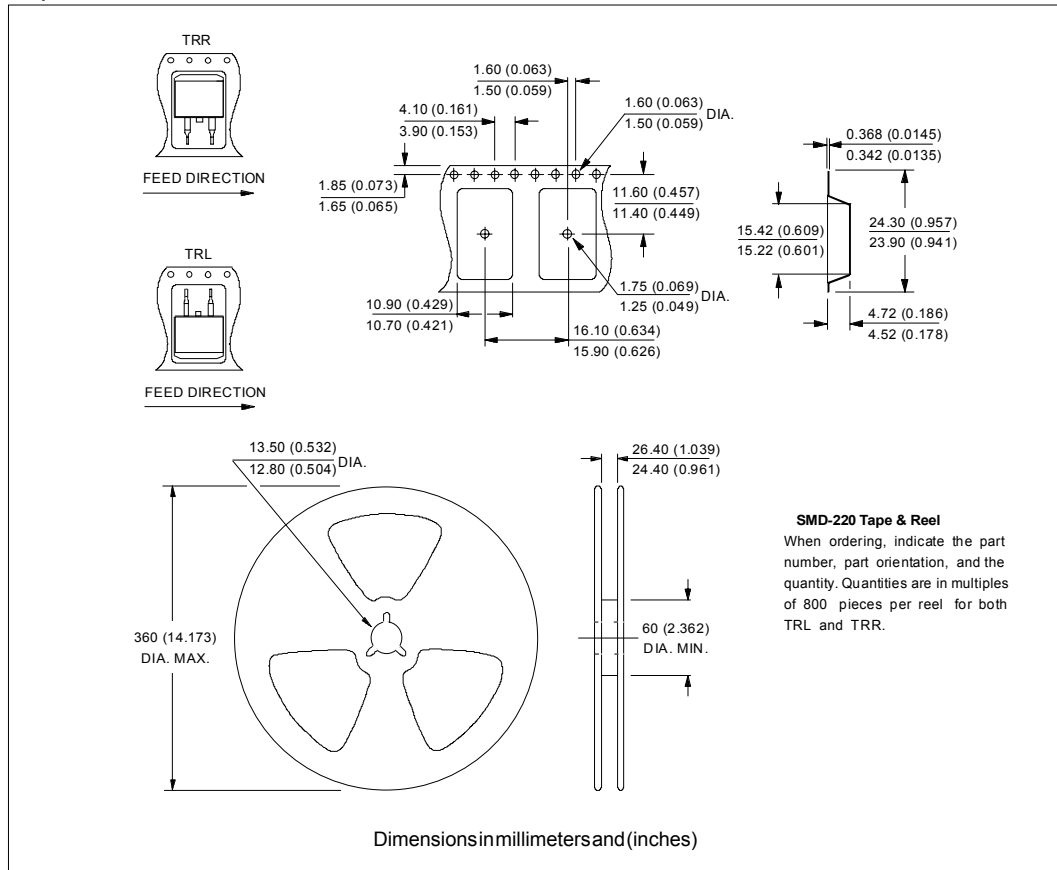

Data and specifications subject to change without notice.
This product has been designed and qualified for Industrial Level.
Qualification Standards can be found on IR's Web site.