



SF1601PT THRU SF1606PT

16.0 AMPS. Glass Passivated Super Fast Rectifiers



Voltage Range
50 to 400 Volts
Current
16.0 Amperes

Features

- ✦ Dual rectifier construction, positive center-tap
- ✦ Plastic package has Underwriters Laboratory Flammability Classifications 94V-0
- ✦ Glass passivated chip junctions
- ✦ Superfast recovery time, high voltage
- ✦ Low forward voltage, high current capability
- ✦ Low thermal resistance
- ✦ Low power loss, high efficiency
- ✦ High temperature soldering guaranteed:
260°C / 10 seconds, 0.16"(4.06mm) lead lengths at 5 lbs., (2.3kg) tesion

Mechanical Data

- ✦ Cases: JEDEC TO-3P/TO-247AD molded plastic
- ✦ Terminals: Leads solderable per MIL-STD-750, Method 2026
- ✦ Polarity: As marked
- ✦ Mounting position: Any
- ✦ Weight: 0.2 ounce, 5.6 grams

TO-3P/TO-247AD

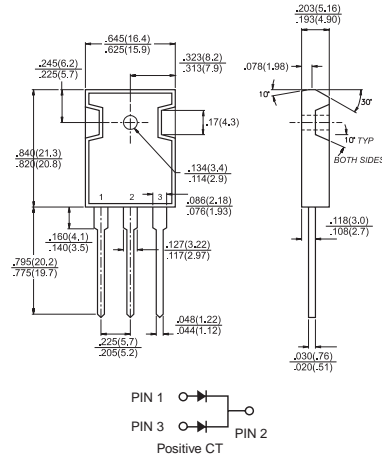

Dimensions in inches and (millimeters)

Maximum Ratings and Electrical Characteristics

Rating at 25°C ambient temperature unless otherwise specified.

Single phase, half wave, 60 Hz, resistive or inductive load.

For capacitive load, derate current by 20%

Type Number	Symbol	SF 1601PT	SF 1602PT	SF 1603PT	SF 1604PT	SF 1605PT	SF 1606PT	Units
Maximum Recurrent Peak Reverse Voltage	V_{RRM}	50	100	150	200	300	400	V
Maximum RMS Voltage	V_{RMS}	35	70	105	140	210	280	V
Maximum DC Blocking Voltage	V_{DC}	50	100	150	200	300	400	V
Maximum Average Forward Rectified Current at $T_c=100^\circ\text{C}$	$I_{(AV)}$	16						A
Peak Forward Surge Current, 8.3 ms Single Half Sine-wave Superimposed on Rated Load (JEDEC method)	I_{FSM}	200						A
Maximum Instantaneous Forward Voltage @8.0A	V_F	0.95				1.3		V
Maximum D.C. Reverse Current @ $T_c=25^\circ\text{C}$ at Rated DC Blocking Voltage @ $T_c=100^\circ\text{C}$	I_R	10.0				500		uA
Maximum Reverse Recovery Time(Note 2) $T_J=25^\circ\text{C}$	T_{rr}	35						nS
Typical Junction Capacitance (Note 1)	C_j	85.0						pF
Typical Thermal Resistance (Note 3)	$R_{\theta_{JC}}$	2						$^\circ\text{C/W}$
Operating Junction Temperature Range	T_J	-55 to +150						$^\circ\text{C}$
Storage Temperature Range	T_{STG}	-55 to +150						$^\circ\text{C}$

Notes: 1. Measured at 1 MHz and Applied Reverse Voltage of 4.0V D.C.

2. Reverse Recovery Test Conditions: $I_F=0.5A$, $I_R=1.0A$, Recover to 0.25A.

3. Mounted on Heatsink. Size of 3" x 5" x 0.25" Al-Plate.

RATINGS AND CHARACTERISTIC CURVES (SF1601PT THRU SF1606PT)

FIG. 1- REVERSE RECOVERY TIME CHARACTERISTIC AND TEST CIRCUIT DIAGRAM

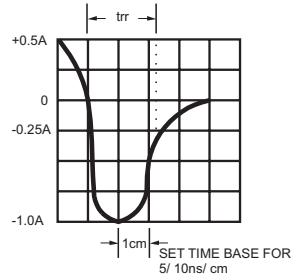
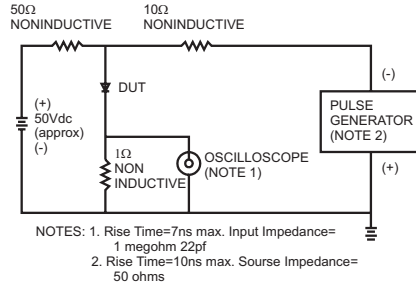

FIG. 2- MAXIMUM FORWARD CURRENT DERATING CURVE

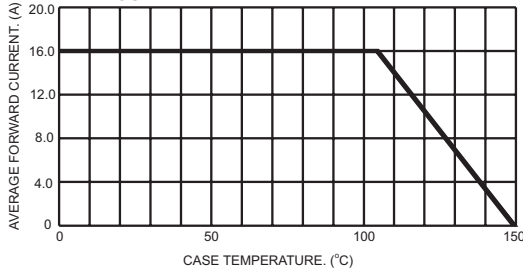

FIG. 3- MAXIMUM NON-REPETITIVE FORWARD SURGE CURRENT PER LEG

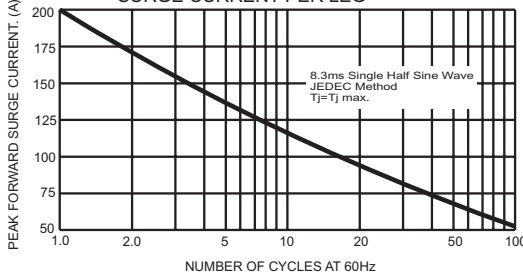

FIG. 4- TYPICAL JUNCTION CAPACITANCE PER LEG

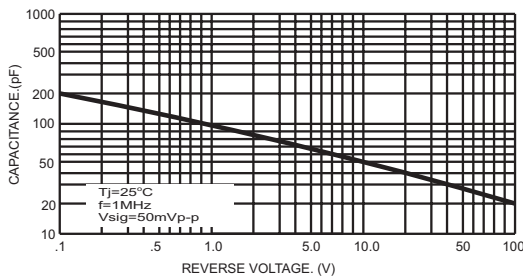

FIG. 5- TYPICAL INSTANTANEOUS FORWARD CHARACTERISTICS PER LEG

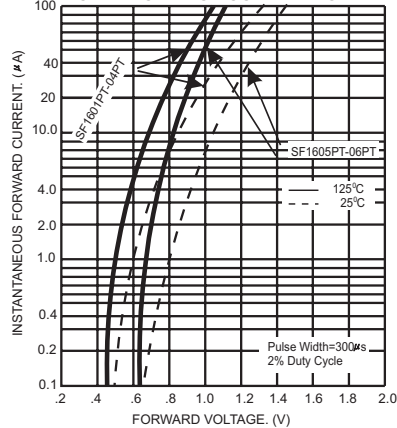

FIG. 6- TYPICAL REVERSE CHARACTERISTICS

