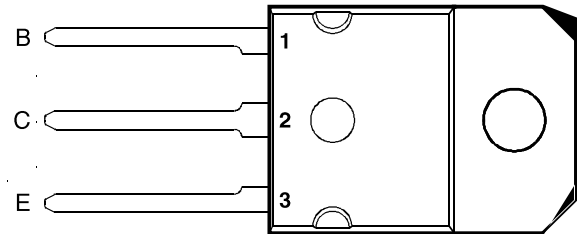

SOT-93 PACKAGE
(TOP VIEW)

Pin 2 is in electrical contact with the mounting base.

- Rugged Triple-Diffused Planar Construction
- 15 A Continuous Collector Current
- 1000 Volt Blocking Capability

absolute maximum ratings at 25°C case temperature (unless otherwise noted)

RATING		SYMBOL	VALUE	UNIT
Collector-emitter voltage ($V_{BE} = 0\text{ V}$)	BUV48	V_{CES}	850	V
	BUV48A		1000	
Collector-emitter voltage ($R_{BE} = 10\ \Omega$)	BUV48	V_{CER}	850	V
	BUV48A		1000	
Collector-emitter voltage ($I_B = 0$)	BUV48	V_{CEO}	400	V
	BUV48A		450	
Continuous collector current		I_C	15	A
Peak collector current (see Note 1)		I_{CM}	30	A
Continuous base current		I_B	4	A
Peak base current		I_{BM}	20	A
Non repetitive accidental peak surge current		I_{CSM}	55	A
Continuous device dissipation at (or below) 25°C case temperature		P_{tot}	125	W
Operating junction temperature range		T_j	-65 to +150	°C
Storage temperature range		T_{stg}	-65 to +150	°C

 NOTE 1: This value applies for $t_p \leq 2\text{ ms}$, duty cycle $\leq 2\%$.

BUV48, BUV48A

NPN SILICON POWER TRANSISTORS

electrical characteristics at 25°C case temperature (unless otherwise noted)

PARAMETER	TEST CONDITIONS			MIN	TYP	MAX	UNIT
$V_{CEO(sus)}$ Collector-emitter sustaining voltage	$I_C = 200\text{ mA}$	$L = 25\text{ mH}$	(see Note 2)	BUV48 400 BUV48A 450			V
I_{CES} Collector-emitter cut-off current	$V_{CE} = 850\text{ V}$	$V_{BE} = 0$		BUV48		0.2	mA
	$V_{CE} = 1000\text{ V}$	$V_{BE} = 0$		BUV48A		0.2	
	$V_{CE} = 850\text{ V}$	$V_{BE} = 0$	$T_C = 125^\circ\text{C}$	BUV48		2.0	
	$V_{CE} = 1000\text{ V}$	$V_{BE} = 0$	$T_C = 125^\circ\text{C}$	BUV48A		2.0	
I_{CER} Collector-emitter cut-off current	$V_{CE} = 850\text{ V}$	$R_{BE} = 10\ \Omega$		BUV48		0.5	mA
	$V_{CE} = 1000\text{ V}$	$R_{BE} = 10\ \Omega$		BUV48A		0.5	
	$V_{CE} = 850\text{ V}$	$R_{BE} = 10\ \Omega$	$T_C = 125^\circ\text{C}$	BUV48		4.0	
	$V_{CE} = 1000\text{ V}$	$R_{BE} = 10\ \Omega$	$T_C = 125^\circ\text{C}$	BUV48A		4.0	
I_{EBO} Emitter cut-off current	$V_{EB} = 5\text{ V}$	$I_C = 0$				1	mA
V_{EBO} Emitter-base breakdown voltage	$I_E = 50\text{ mA}$	$I_C = 0$		7		30	V
$V_{CE(sat)}$ Collector-emitter saturation voltage	$I_B = 2\text{ A}$	$I_C = 10\text{ A}$		BUV48		1.5	V
	$I_B = 3\text{ A}$	$I_C = 15\text{ A}$	(see Notes 3 and 4)	BUV48		5.0	
	$I_B = 1.6\text{ A}$	$I_C = 8\text{ A}$		BUV48A		1.5	
	$I_B = 2.4\text{ A}$	$I_C = 12\text{ A}$		BUV48A		5.0	
$V_{BE(sat)}$ Base-emitter saturation voltage	$I_B = 2\text{ A}$	$I_C = 10\text{ A}$	(see Notes 3 and 4)	BUV48		1.6	V
	$I_B = 1.6\text{ A}$	$I_C = 8\text{ A}$		BUV48A		1.6	
f_t Current gain bandwidth product	$V_{CE} = 10\text{ V}$	$I_C = 0.5\text{ A}$	$f = 1\text{ MHz}$		10		MHz
C_{ob} Output capacitance	$V_{CB} = 20\text{ V}$	$I_C = 0$	$f = 1\text{ MHz}$		150		pF

NOTES: 2. Inductive loop switching measurement.

3. These parameters must be measured using pulse techniques, $t_p = 300\ \mu\text{s}$, duty cycle $\leq 2\%$.

4. These parameters must be measured using voltage-sensing contacts, separate from the current carrying contacts.

thermal characteristics

PARAMETER	MIN	TYP	MAX	UNIT
$R_{\theta JC}$ Junction to case thermal resistance			1	$^\circ\text{C/W}$

resistive-load-switching characteristics at 25°C case temperature

PARAMETER	TEST CONDITIONS †			MIN	TYP	MAX	UNIT				
t_{on} Turn on time	$I_C = 10\text{ A}$	$V_{CC} = 150\text{ V}$	BUV48			1.0	μs				
t_s Storage time						$I_{B(on)} = 2\text{ A}$	$I_{B(off)} = -2\text{ A}$	(see Figures 1 and 2)		3.0	μs
t_f Fall time										0.8	μs
t_{on} Turn on time	$I_C = 8\text{ A}$	$V_{CC} = 150\text{ V}$	BUV48A			1.0	μs				
t_s Storage time						$I_{B(on)} = 1.6\text{ A}$	$I_{B(off)} = -1.6\text{ A}$	(see Figures 1 and 2)		3.0	μs
t_f Fall time										0.8	μs

† Voltage and current values shown are nominal; exact values vary slightly with transistor parameters.

inductive-load-switching characteristics at 100°C case temperature

PARAMETER	TEST CONDITIONS †			MIN	TYP	MAX	UNIT
t_{sv} Voltage storage time	$I_C = 10\text{ A}$	$I_{B(on)} = 2\text{ A}$	BUV48			4.0	μs
t_{fi} Current fall time						$V_{BE(off)} = -5\text{ V}$	(see Figures 3 and 4)
t_{sv} Voltage storage time	$I_C = 8\text{ A}$	$I_{B(on)} = 1.6\text{ A}$	BUV48A			4.0	μs
t_{fi} Current fall time						$V_{BE(off)} = -5\text{ V}$	(see Figures 3 and 4)

PARAMETER MEASUREMENT INFORMATION

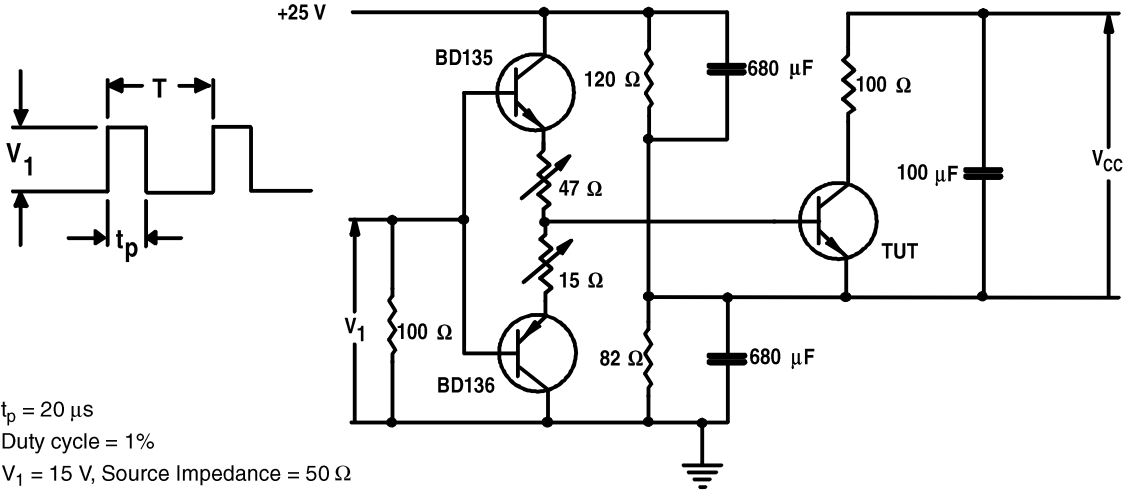

Figure 1. Resistive-Load Switching Test Circuit

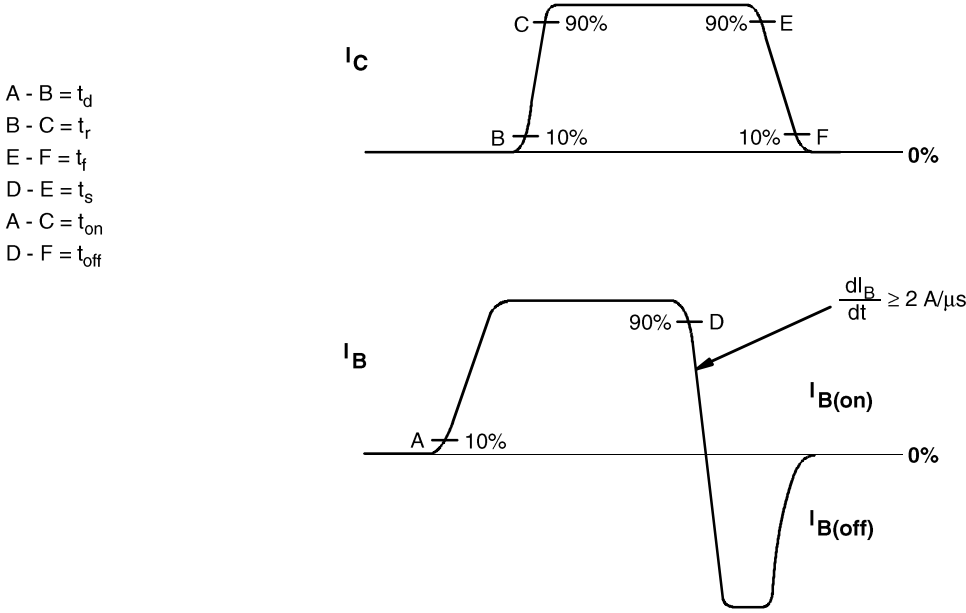

Figure 2. Resistive-Load Switching Waveform

TYPICAL CHARACTERISTICS

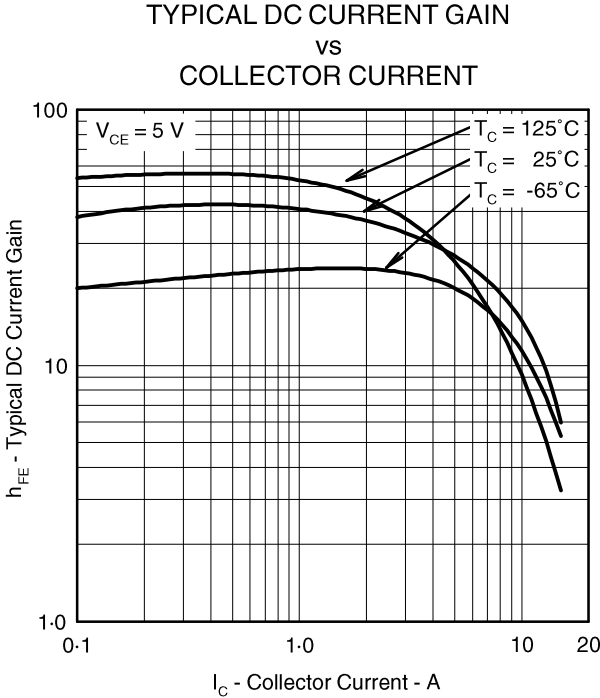

Figure 5.

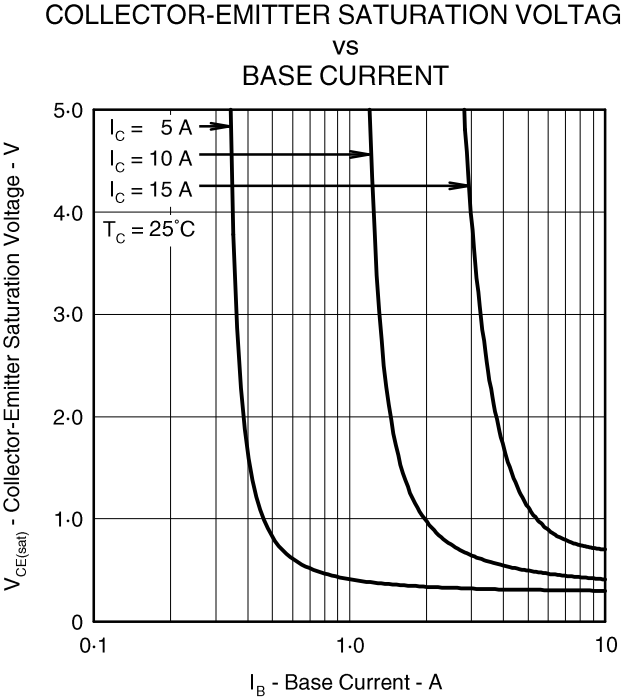

Figure 6.

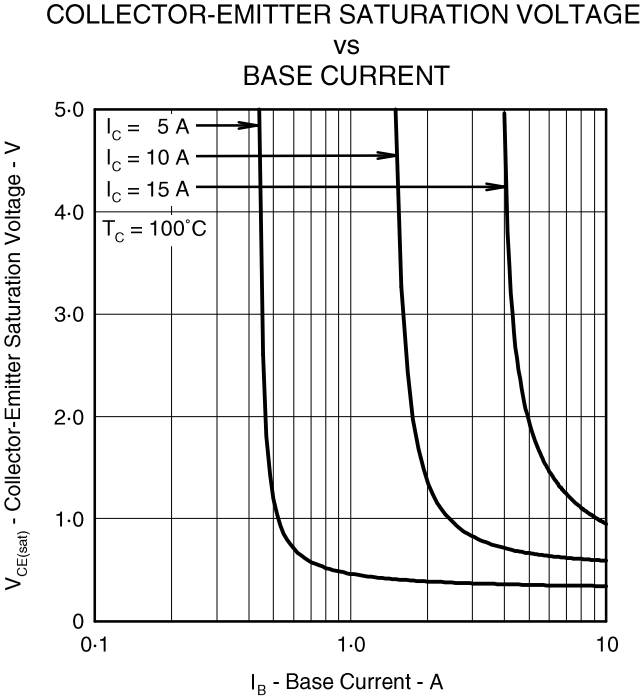

Figure 7.

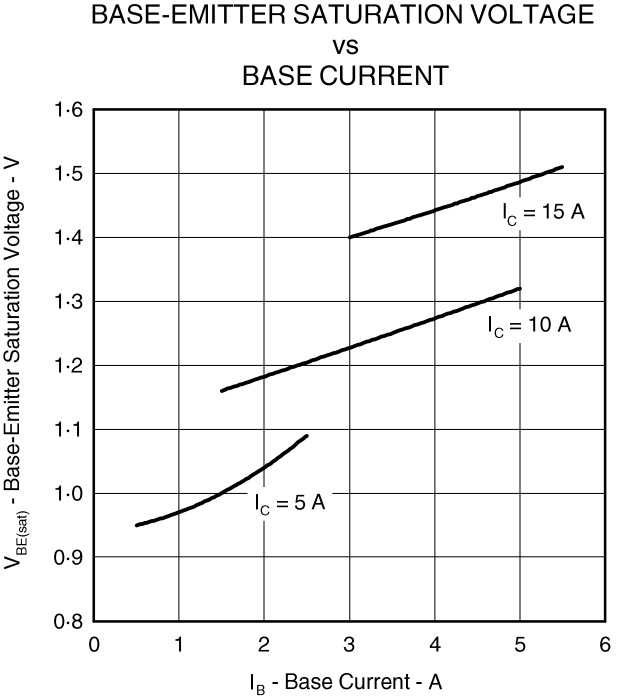

Figure 8.

TYPICAL CHARACTERISTICS

COLLECTOR CUT-OFF CURRENT
 VS
 CASE TEMPERATURE

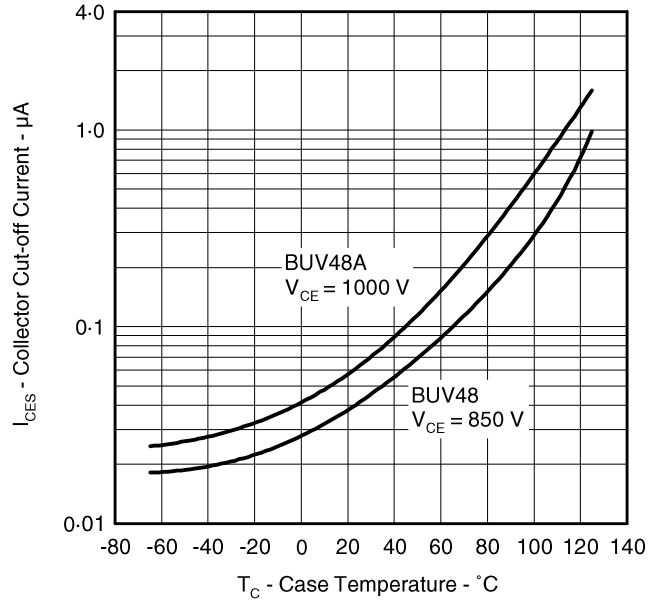

Figure 9.

MAXIMUM SAFE OPERATING REGIONS

MAXIMUM FORWARD-BIAS
 SAFE OPERATING AREA

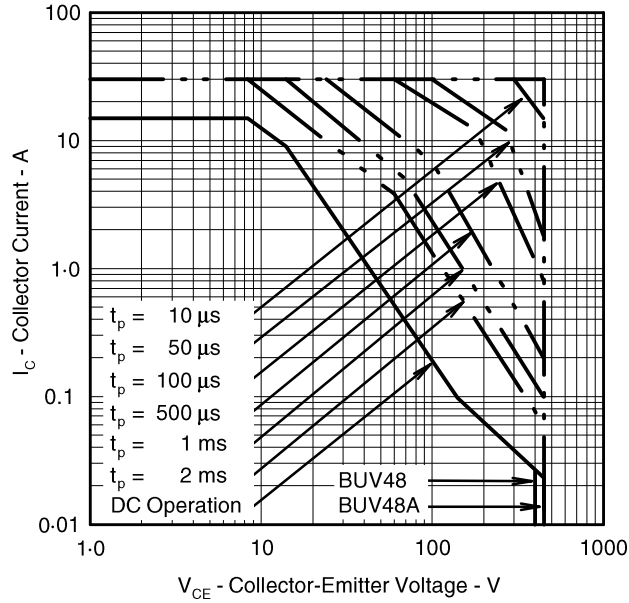

Figure 10.

MECHANICAL DATA

SOT-93

3-pin plastic flange-mount package

This single-in-line package consists of a circuit mounted on a lead frame and encapsulated within a plastic compound. The compound will withstand soldering temperature with no deformation, and circuit performance characteristics will remain stable when operated in high humidity conditions. Leads require no additional cleaning or processing when used in soldered assembly.

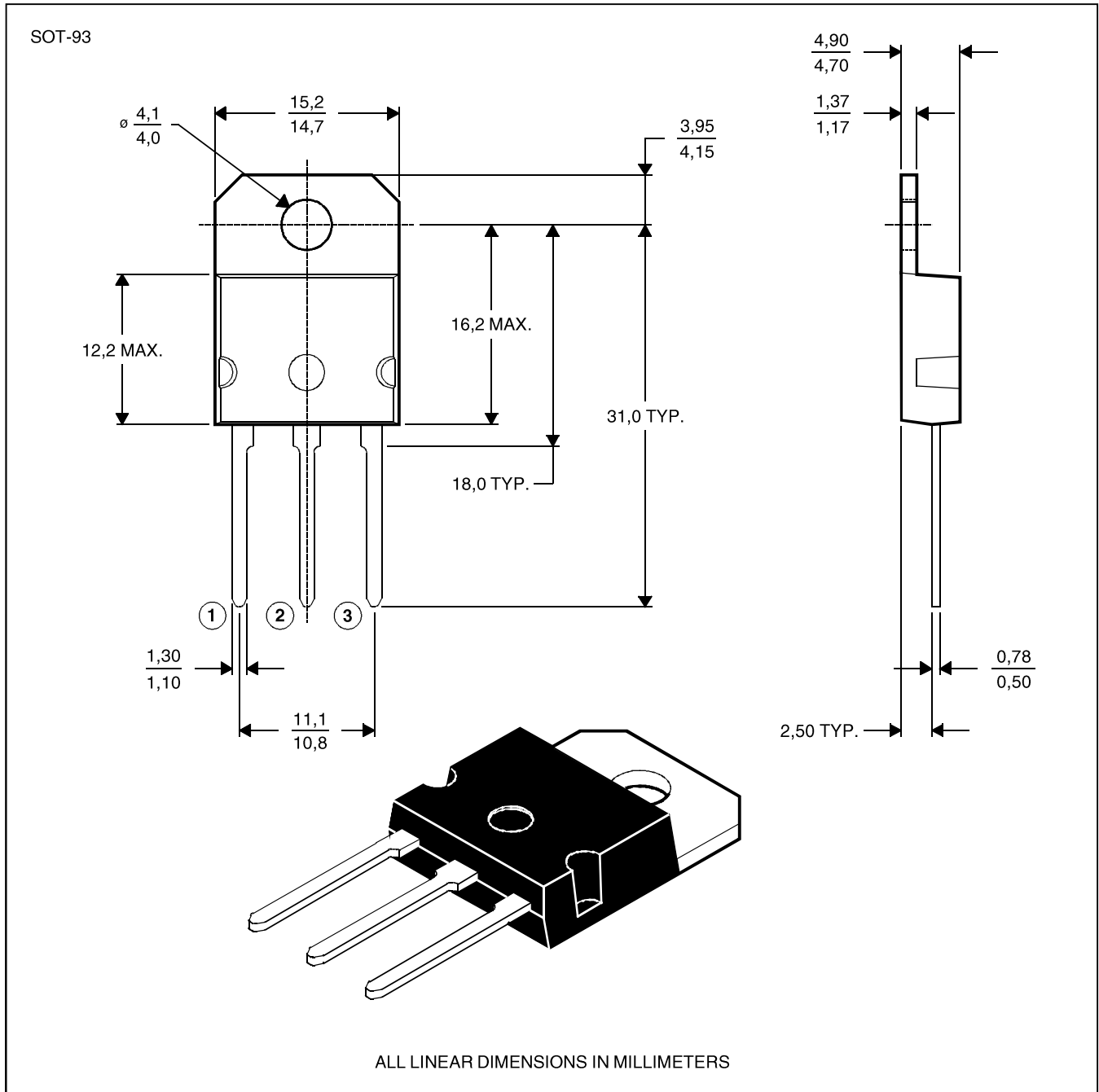

NOTE A: The centre pin is in electrical contact with the mounting tab.