

The RF MOSFET Line
RF Power Field-Effect Transistor
N-Channel Enhancement-Mode Lateral MOSFET

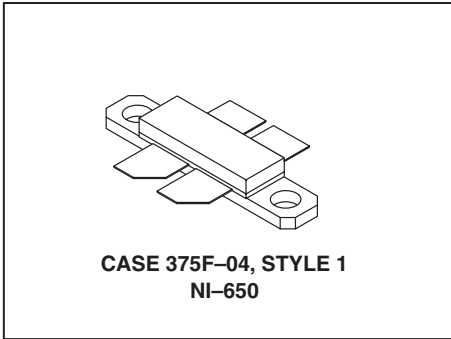

470 – 860 MHz, 130 W, 32 V
LATERAL N-CHANNEL
BROADBAND
RF POWER MOSFET



Designed for broadband commercial and industrial applications with frequencies from 470 to 860 MHz. The high gain and broadband performance of this device make it ideal for large-signal, common source amplifier applications in 28/32 volt transmitter equipment.

- Typical Two-Tone Performance @ 860 MHz, 32 Volts, Narrowband Fixture
 Output Power — 130 Watts PEP
 Power Gain — 17.3 dB
 Efficiency — 41%
 IMD — -32.5 dBc
- 100% Tested for Load Mismatch Stress at All Phase Angles with 10:1 VSWR @ 32 Vdc, 860 MHz, 130 Watts, f1 = 857 MHz, f2 = 863 MHz
- Integrated ESD Protection
- Excellent Thermal Stability
- Characterized with Differential Large-Signal Impedance Parameters

MAXIMUM RATINGS

Rating	Symbol	Value	Unit
Drain-Source Voltage	V _{DSS}	70	Vdc
Gate-Source Voltage	V _{GS}	- 0.5, +15	Vdc
Total Device Dissipation @ T _C = 25°C Derate above 25°C	P _D	302 1.72	Watts W/°C
Storage Temperature Range	T _{stg}	- 65 to +150	°C
Operating Junction Temperature	T _J	200	°C

ESD PROTECTION CHARACTERISTICS

Test Conditions	Class
Human Body Model	1 (Minimum)
Machine Model	M2 (Minimum)

THERMAL CHARACTERISTICS

Characteristic	Symbol	Max	Unit
Thermal Resistance, Junction to Case	R _{θJC}	0.58	°C/W

NOTE – **CAUTION** – MOS devices are susceptible to damage from electrostatic charge. Reasonable precautions in handling and packaging MOS devices should be observed.

Freescale Semiconductor, Inc.

ELECTRICAL CHARACTERISTICS (T_C = 25°C unless otherwise noted)

Characteristic	Symbol	Min	Typ	Max	Unit
----------------	--------	-----	-----	-----	------

OFF CHARACTERISTICS (1)

Drain–Source Breakdown Voltage (V _{GS} = 0 Vdc, I _D = 10 μA)	V _{(BR)DSS}	70	—	—	Vdc
Zero Gate Voltage Drain Current (V _{DS} = 32 Vdc, V _{GS} = 0 Vdc)	I _{DSS}	—	—	1	μAdc
Gate–Source Leakage Current (V _{GS} = 5 Vdc, V _{DS} = 0 Vdc)	I _{GSS}	—	—	1	μAdc

ON CHARACTERISTICS (1)

Gate Threshold Voltage (V _{DS} = 10 V, I _D = 200 μA)	V _{GS(th)}	2	2.9	4	Vdc
Gate Quiescent Voltage (V _{DS} = 32 V, I _D = 100 mA)	V _{GS(Q)}	2.5	3.3	4.5	Vdc
Drain–Source On–Voltage (V _{GS} = 10 V, I _D = 3 A)	V _{DS(on)}	—	0.41	0.45	Vdc

DYNAMIC CHARACTERISTICS (1)

Input Capacitance (V _{DS} = 32 V, V _{GS} = 0 V, f = 1 MHz)	C _{iss}	—	97.3	—	pF
Output Capacitance (V _{DS} = 32 V, V _{GS} = 0 V, f = 1 MHz)	C _{oss}	—	49	—	pF
Reverse Transfer Capacitance (V _{DS} = 32 V, V _{GS} = 0 V, f = 1 MHz)	C _{rss}	—	1.91	—	pF

FUNCTIONAL CHARACTERISTICS, NARROWBAND OPERATION (In Motorola MRF374A Narrowband Circuit, 50 ohm system) (2)

Common Source Power Gain (V _{DD} = 32 Vdc, P _{out} = 130 W PEP, I _{DQ} = 2 x 200 mA, f ₁ = 857 MHz, f ₂ = 863 MHz)	G _{ps}	16	17.3	—	dB
Drain Efficiency (V _{DD} = 32 Vdc, P _{out} = 130 W PEP, I _{DQ} = 2 x 200 mA, f ₁ = 857 MHz, f ₂ = 863 MHz)	η	36	41.2	—	%
Intermodulation Distortion (V _{DD} = 32 Vdc, P _{out} = 130 W PEP, I _{DQ} = 2 x 200 mA, f ₁ = 857 MHz, f ₂ = 863 MHz)	IMD	—	–32.5	–28	dB
Load Mismatch (V _{DD} = 32 Vdc, P _{out} = 130 W Two–Tone, I _{DQ} = 2 x 200 mA, f ₁ = 857 MHz, f ₂ = 863 MHz, VSWR 10:1 at All Phase Angles of Test)		No Degradation in Output Power			

TYPICAL CHARACTERISTICS, BROADBAND OPERATION (In Motorola MRF374 Broadband Circuit, 50 ohm system)

Common Source Power Gain (V _{DD} = 32 Vdc, P _{out} = 100 W PEP, I _{DQ} = 750 mA, f ₁ = 857 MHz, f ₂ = 863 MHz)	G _{ps}	—	15.8	—	dB
Drain Efficiency (V _{DD} = 32 Vdc, P _{out} = 100 W PEP, I _{DQ} = 750 mA, f ₁ = 857 MHz, f ₂ = 863 MHz)	η	—	35	—	%
Intermodulation Distortion (V _{DD} = 32 Vdc, P _{out} = 100 W PEP, I _{DQ} = 750 mA, f ₁ = 857 MHz, f ₂ = 863 MHz)	IMD	—	34.5	—	dB

(1) Each side of device measured separately.

(2) Measured in push–pull configuration.

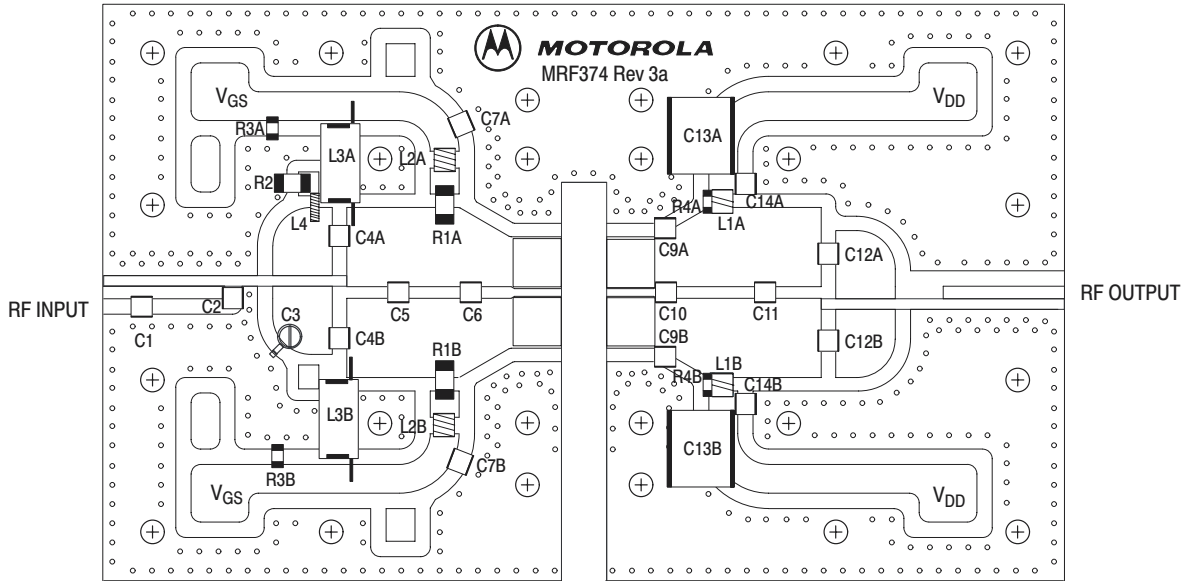

Vertical Balun Mounting Detail

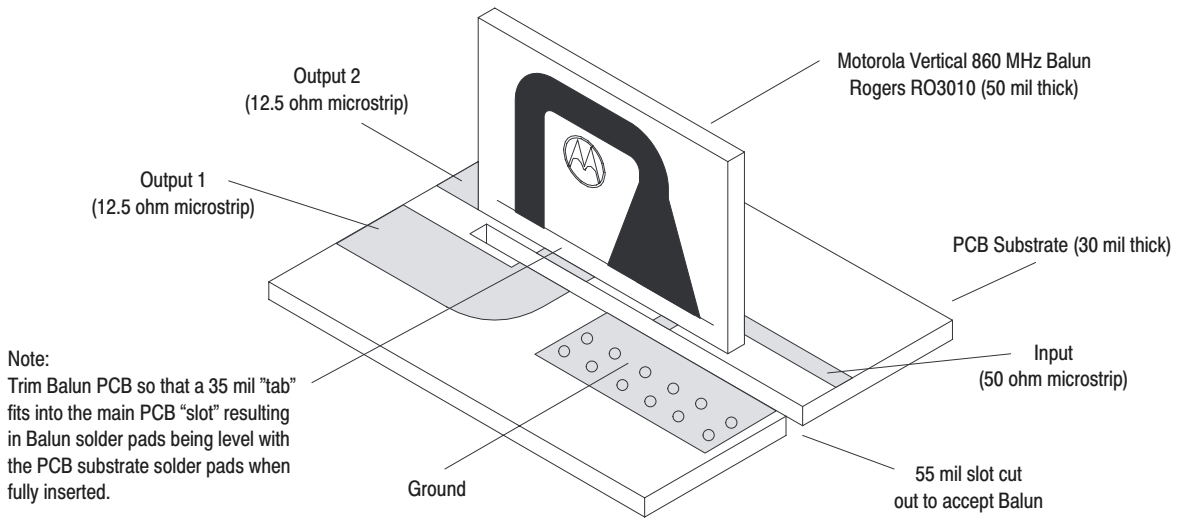
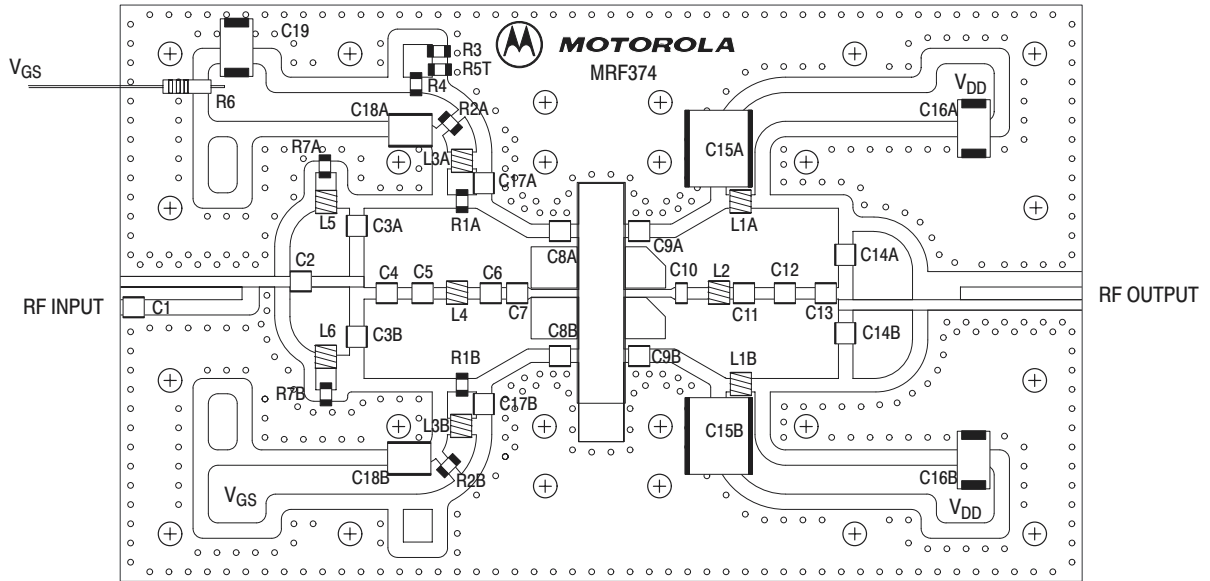

Figure 1. MRF374A Narrowband Test Circuit Component Layout

Freescale Semiconductor, Inc.

Table 1. MRF374A Narrowband Test Circuit Component Layout Designations and Values

Designation	Description
C1	0.8 pF Chip Capacitor, B Case, ATC
C2	2.2 pF Chip Capacitor, B Case, ATC
C3	0.5 – 5.0 pF Variable Capacitor, Johanson Gigatrim
C4A, B, C12A, B	47 pF Chip Capacitors, B Case, ATC
C5	1.0 pF Chip Capacitor, B Case, ATC
C6	10 pF Chip Capacitor, B Case, ATC
C7A, B, C14A, B	100,000 pF Chip Capacitors, B Case, ATC
C9A, B	15 pF Chip Capacitors, B Case, ATC
C10	3.9 pF Chip Capacitor, B Case, ATC
C11	5.1 pF Chip Capacitor, B Case, ATC
C13A, B	2.2 μ F, 100 V Chip Capacitors, Vishay #VJ3640Y225KXBAT
L1A, B	5.0 nH, Coilcraft #A02T
L2A, B	8.0 nH, Coilcraft #A03T
L3A, B	130.0 nH, Coilcraft #132–11SMJ
L4	8.8 nH, Coilcraft #1606–8
R1A, B	51 Ω , 1/4 W Chip Resistors, Vishay Dale (1210)
R2	10 Ω , 1/2 W Chip Resistor, Vishay Dale (2010)
R3A, B	3.3 k Ω , 1/8 W Chip Resistors, Vishay Dale (1206)
R4A, B	180 Ω , 1/4 W Chip Resistors, Vishay Dale (1210)
PCB	MRF374 Printed Circuit Board Rev 03, Rogers RO4350, Height 30 mils, $\epsilon_r = 3.48$
Balun B1A, B	Vertical 860 MHz Narrowband Balun, Printed Circuit Board Rev 01, Rogers RO3010, Height 50 mils, $\epsilon_r = 10.2$



Vertical Balun Mounting Detail

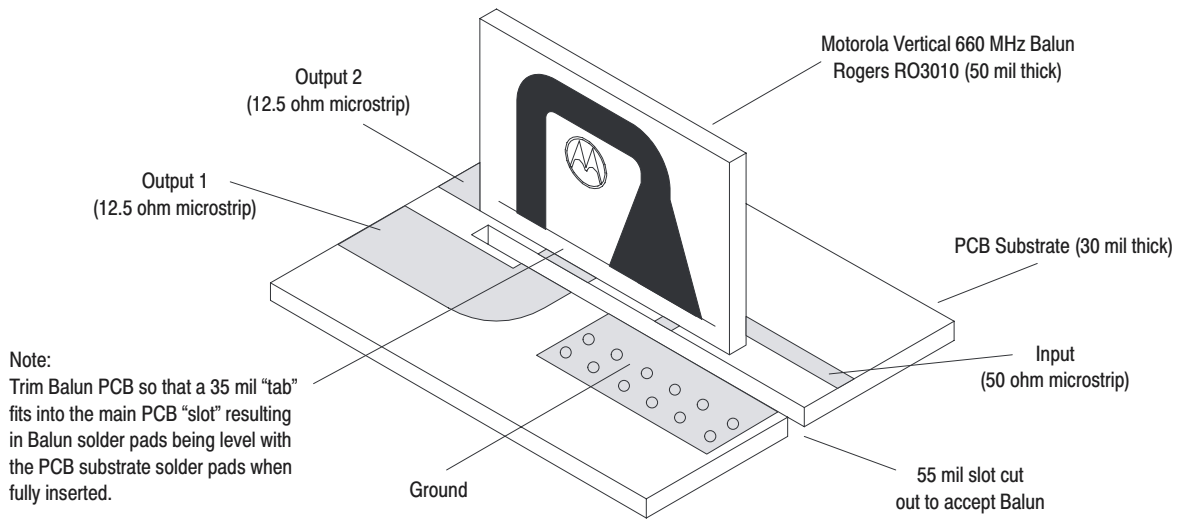

Figure 2. MRF374 Broadband Test Circuit Component Layout

Freescale Semiconductor, Inc.

Table 2. MRF374 Broadband Test Circuit Component Designations and Values

Designation	Description
C1	0.8 pF Chip Capacitor, B Case, ATC
C2	8.2 pF Chip Capacitor, B Case, ATC
C3A, B, C14A, B	100 pF Chip Capacitors, B Case, ATC
C4	7.5 pF Chip Capacitor, B Case, ATC
C5	3.0 pF Chip Capacitor, B Case, ATC
C6	9.1 pF Chip Capacitor, B Case, ATC
C7	15 pF Chip Capacitor, B Case, ATC
C8A, B	12 pF Chip Capacitors, B Case, ATC
C9A, B	4.7 pF Chip Capacitors, B Case, ATC
C10	10 pF Chip Capacitor, B Case, ATC
C11	3.6 pF Chip Capacitor, B Case, ATC
C12	3.0 pF Chip Capacitor, B Case, ATC
C13	2.7 pF Chip Capacitor, B Case, ATC
C15A, B	3.3 μ F, 100 V Chip Capacitors, Vitramon #VJ3640Y335KXBAT
C16A, B	22 μ F, 35 V Chip Capacitors, Kemet #491D226K035AS
C17A, B	3.9 pF Chip Capacitors, B Case, ATC
C18A, B	2.2 μ F, 50 V Chip Capacitors, Vitramon #VJ2225Y225KXAAT
C19	10 μ F, 35 V Chip Capacitor, Kemet #T491D106K035AS
L1A, B, L3A, B, L4, L5	8.0 nH, Coilcraft #A03T
L2, L6	12.5 nH, Coilcraft #A04T
R1A, B	22 Ω , 1/8 W Chip Resistor, Vishay Dale (1206)
R2A, B, R7A, B	10 Ω , 1/8 W Chip Resistor, Vishay Dale (1206)
R3	390 Ω , 1/8 W Chip Resistor, Vishay Dale (1206)
R4	2.4 k Ω , 1/8 W Chip Resistor, Vishay Dale (1206)
R5T	470 Ω Thermistor, KOA SPEER MOT #0680149M01
R6	6.8 k Ω , 1/2 W Resistor (Axial Lead), Vishay Dale (2010)
PCB	MRF374 Printed Circuit Board Rev 03, Rogers RO4350, Height 30 mils, $\epsilon_r = 3.48$
Balun B1, B2	Vertical 660 MHz Broadband Balun, Printed Circuit Board Rev 01, Rogers RO3010, Height 50 mils, $\epsilon_r = 10.2$

Freescale Semiconductor, Inc.

MRF374A TYPICAL CHARACTERISTICS

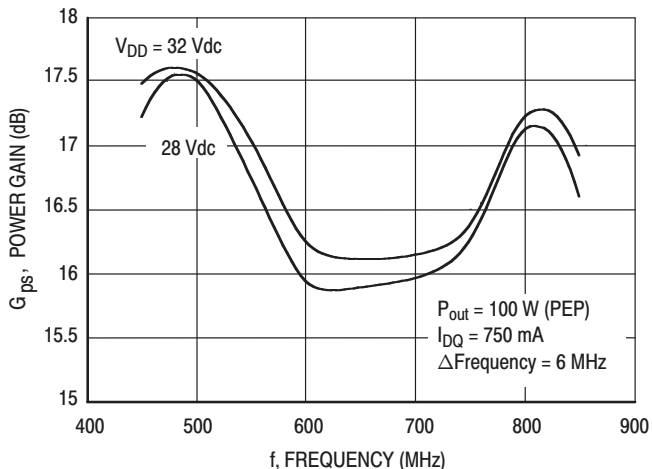

Figure 3. Gain versus Frequency in Broadband Circuit

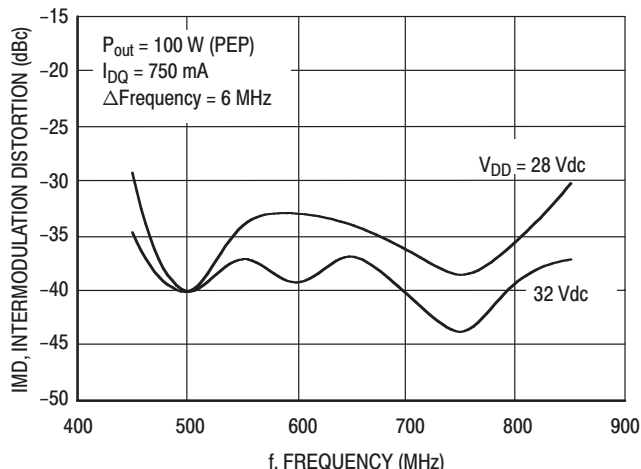

Figure 4. Intermodulation Distortion versus Frequency in Broadband Circuit

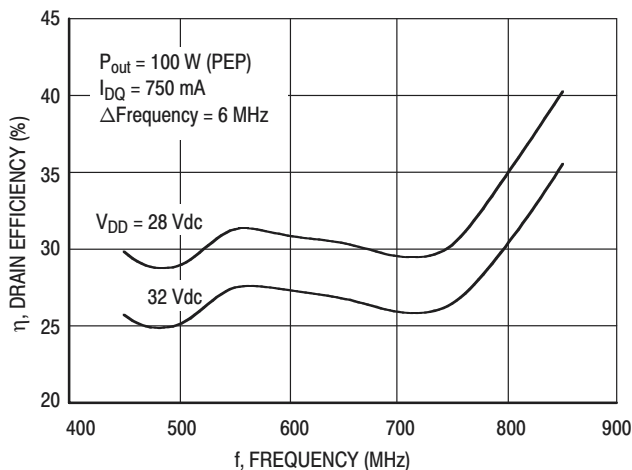

Figure 5. Drain Efficiency versus Frequency in Broadband Circuit

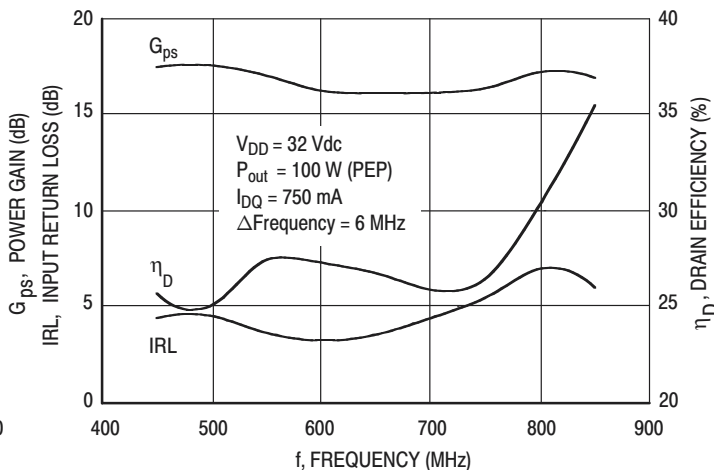

Figure 6. Performance in Broadband Circuit

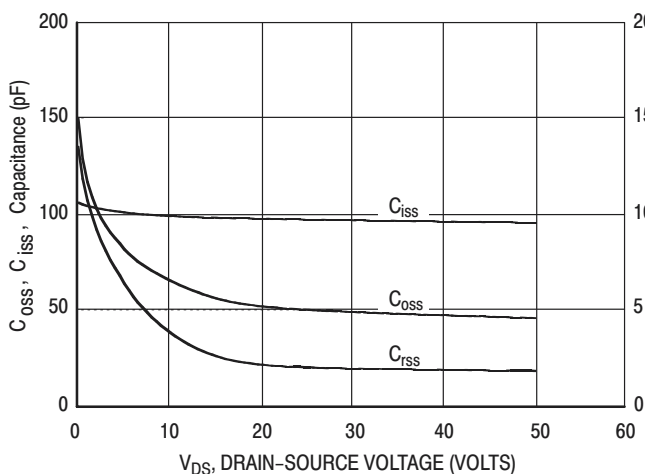

Figure 7. Capacitance versus Voltage

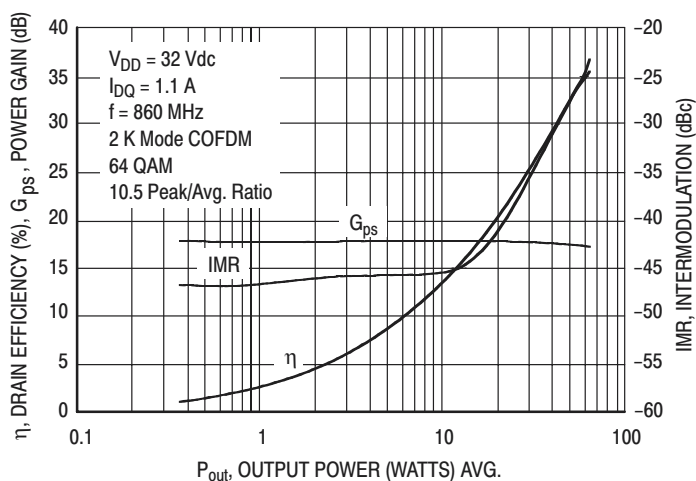

Figure 8. COFDM Intermodulation, Gain and Efficiency versus Output Power in Broadband Circuit

MRF374A TYPICAL CHARACTERISTICS

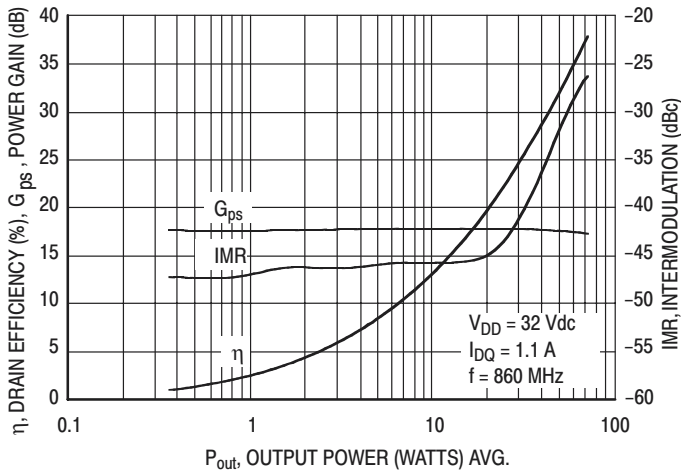

Figure 9. 8-VSB Intermodulation, Gain and Efficiency versus Output Power in Broadband Circuit

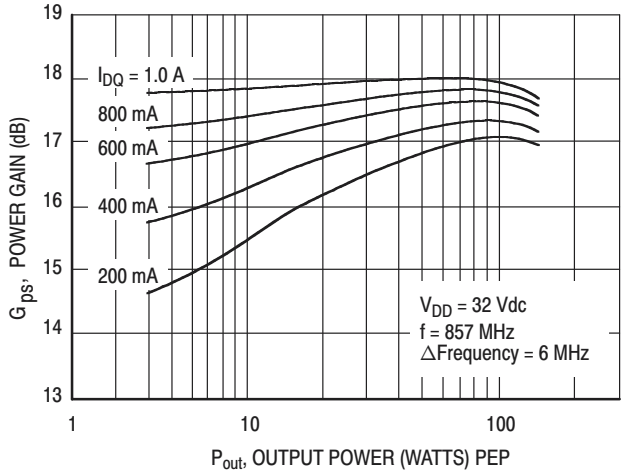

Figure 10. Power Gain versus Peak Output Power in Narrowband Circuit

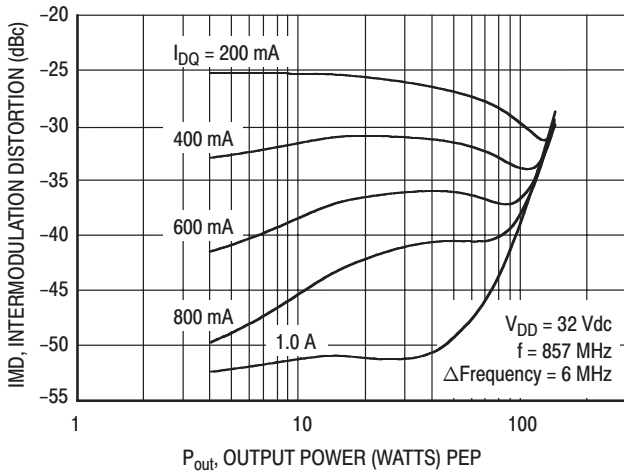

Figure 11. Intermodulation Distortion versus Peak Output Power in Narrowband Circuit

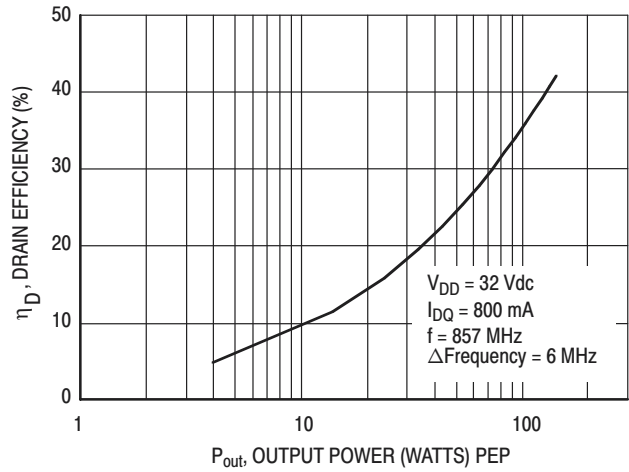

Figure 12. Drain Efficiency versus Peak Output Power in Narrowband Circuit

MRF374A TYPICAL CHARACTERISTICS

$V_{DD} = 28 \text{ Vdc}$

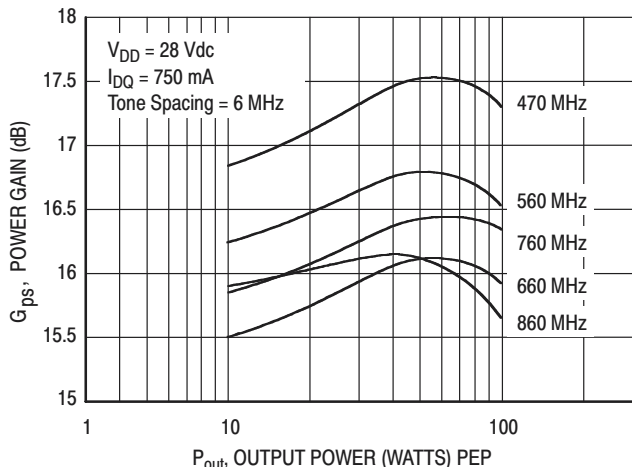

Figure 13. Power Gain versus Peak Output Power in Broadband Circuit

$V_{DD} = 32 \text{ Vdc}$

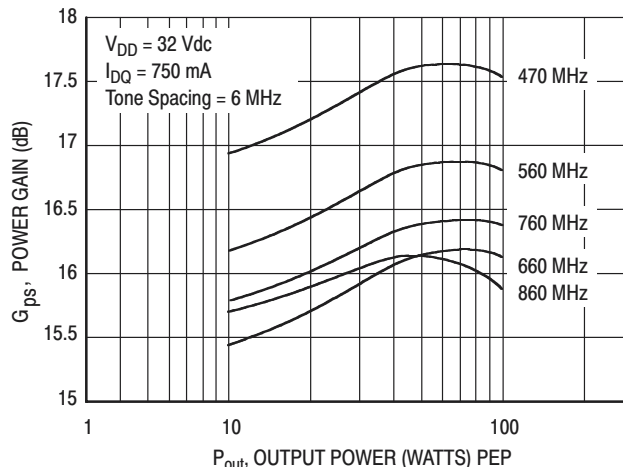

Figure 14. Power Gain versus Peak Output Power in Broadband Circuit

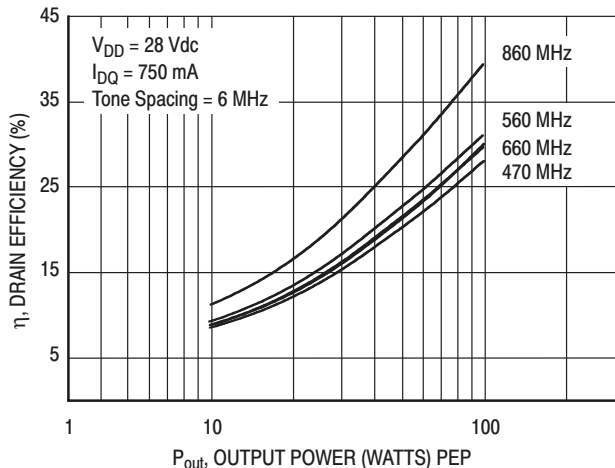

Figure 15. Drain Efficiency versus Peak Output Power in Broadband Circuit

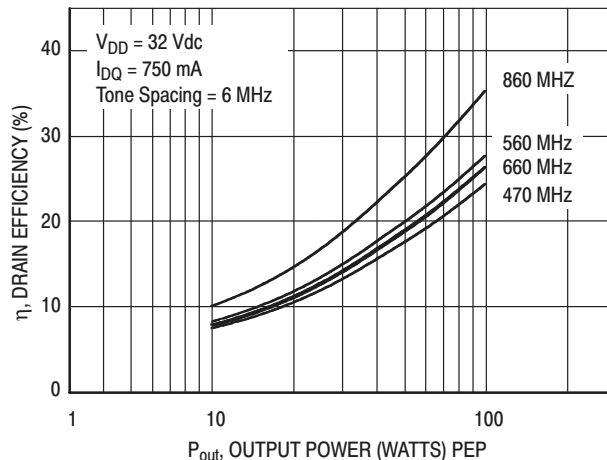

Figure 16. Drain Efficiency versus Peak Output Power in Broadband Circuit

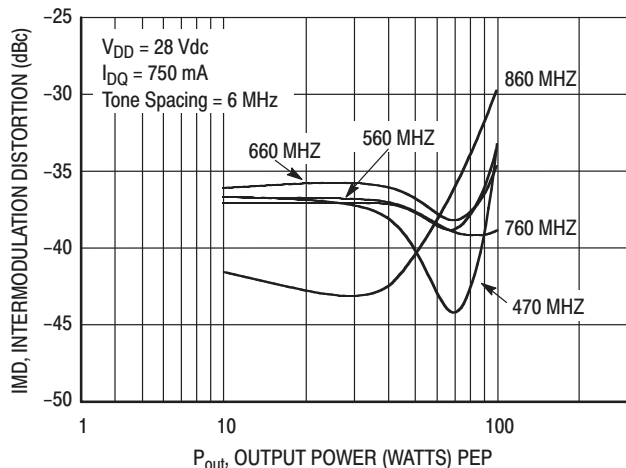

Figure 17. Intermodulation Distortion versus Peak Output Power in Broadband Circuit

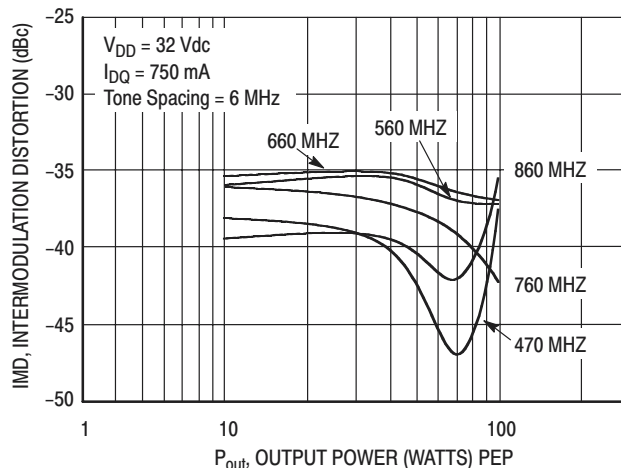
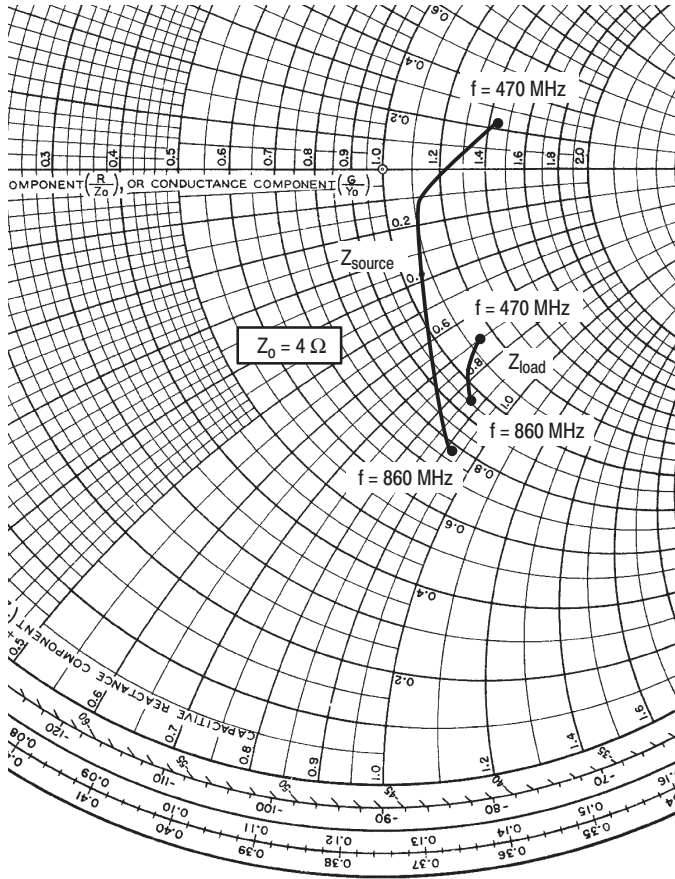

Figure 18. Intermodulation Distortion versus Peak Output Power in Broadband Circuit



MRF374

$V_{DD} = 28 \text{ V}$, $I_{DQ} = 400 \text{ mA}$, $P_{out} = 100 \text{ W PEP}$

f MHz	Z_{source} Ω	Z_{load} Ω
470	$5.79 + j0.97$	$4.54 - j2.82$
660	$4.52 - j0.50$	$4.21 - j3.04$
860	$3.16 - j3.73$	$3.86 - j3.44$

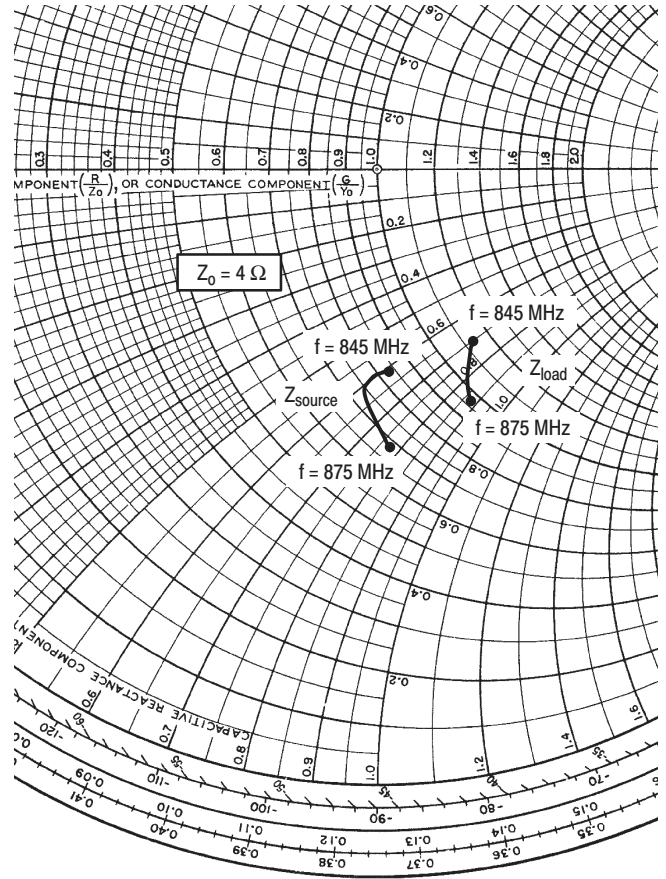

MRF374A

$V_{DD} = 32 \text{ V}$, $I_{DQ} = 400 \text{ mA}$, $P_{out} = 130 \text{ W PEP}$

f MHz	Z_{source} Ω	Z_{load} Ω
845	$3.33 - j2.42$	$4.56 - j2.86$
860	$3.03 - j2.39$	$4.22 - j3.16$
875	$2.73 - j3.10$	$3.87 - j3.52$

Z_{source} = Test circuit impedance as measured from gate to gate, balanced configuration.

Z_{load} = Test circuit impedance as measured from drain to drain, balanced configuration.

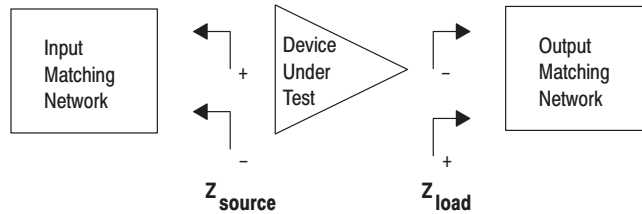
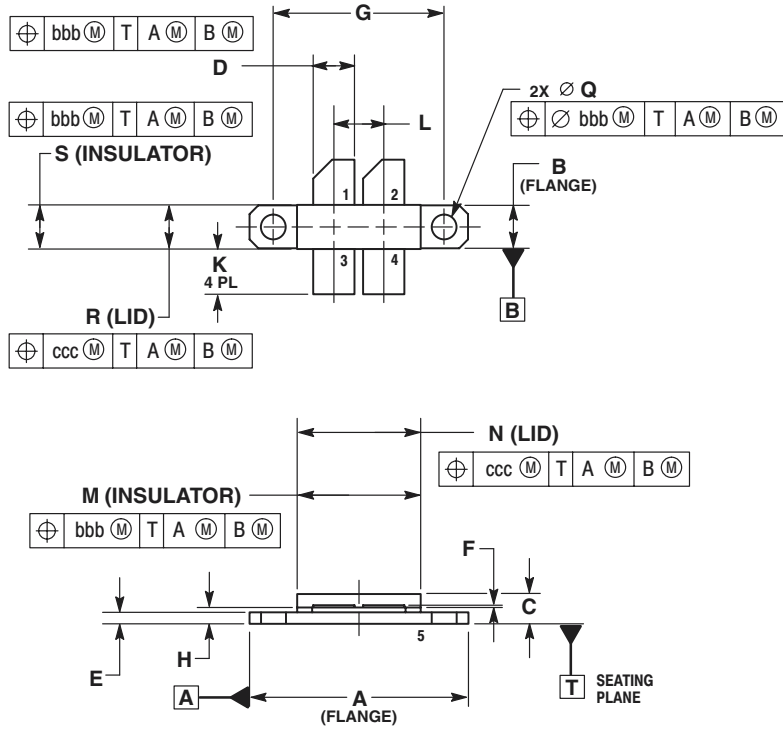

Figure 19. Series Equivalent Input and Output Impedance

NOTES

Freescale Semiconductor, Inc.

PACKAGE DIMENSIONS



- NOTES:
1. DIMENSIONING AND TOLERANCING PER ANSI Y14.5M, 1994.
 2. CONTROLLING DIMENSION: INCH.
 3. DIMENSION H IS MEASURED 0.030 (0.762) AWAY FROM PACKAGE BODY.

DIM	INCHES		MILLIMETERS	
	MIN	MAX	MIN	MAX
A	1.135	1.145	28.80	29.10
B	0.225	0.235	5.72	5.97
C	0.135	0.178	3.43	4.52
D	0.210	0.220	5.33	5.59
E	0.055	0.065	1.40	1.65
F	0.004	0.006	0.11	0.15
G	0.900 BSC		22.86 BSC	
H	0.077	0.087	1.96	2.21
K	0.220	0.250	5.59	6.35
L	0.260 BSC		6.60 BSC	
M	0.643	0.657	16.33	16.69
N	0.638	0.650	16.20	16.50
Q	Ø .125	Ø .135	Ø 3.175	Ø 3.43
R	0.227	0.233	5.77	5.92
S	0.225	0.235	5.715	5.97
bbb	0.010 BSC		0.254 BSC	
ccc	0.015 BSC		0.381 BSC	

- STYLE 1:
- PIN 1. DRAIN
 - DRAIN
 - GATE
 - GATE
 - SOURCE

**CASE 375F-04
ISSUE D
NI-650**

Motorola reserves the right to make changes without further notice to any products herein. Motorola makes no warranty, representation, or guarantee regarding the suitability of its products for any particular purpose, nor does Motorola assume any liability arising out of the application or use of any product or circuit, and specifically disclaims any and all liability, including without limitation consequential or incidental damages. "Typical" parameters can and do vary in different applications and actual performance may vary over time. All operating parameters, including "Typicals", must be validated for each customer application by customer's technical experts. Motorola does not convey any license under its patent rights nor the rights of others. Motorola products are not designed, intended, or authorized for use as components in systems intended for surgical implant into the body, or other applications intended to support or sustain life, or for any other application in which the failure of the Motorola product could create a situation where personal injury or death may occur. Should Buyer purchase or use Motorola products for any such unintended or unauthorized application, Buyer shall indemnify and hold Motorola and its officers, employees, subsidiaries, affiliates, and distributors harmless against all claims, costs, damages, and expenses, and reasonable attorney fees arising out of, directly or indirectly, any claim of personal injury or death associated with such unintended or unauthorized use, even if such claim alleges that Motorola was negligent regarding the design or manufacture of the part. Motorola and the Stylized M Logo are registered trademarks of Motorola, Inc. Motorola, Inc. is an Equal Opportunity/Affirmative Action Employer.

Motorola and the Stylized M Logo are registered in the US Patent & Trademark Office. All other product or service names are the property of their respective owners.

© Motorola, Inc. 2003.

How to reach us:

USA/EUROPE/Locations Not Listed: Motorola Literature Distribution; P.O. Box 5405, Denver, Colorado 80217. 1-303-675-2140 or 1-800-441-2447

JAPAN: Motorola Japan Ltd.; SPS, Technical Information Center, 3-20-1, Minami-Azabu, Minato-ku, Tokyo 106-8573 Japan. 81-3-3440-3569

ASIA/PACIFIC: Motorola Semiconductors H.K. Ltd.; Silicon Harbour Centre, 2 Dai King Street, Tai Po Industrial Estate, Tai Po, N.T. Hong Kong. 852-2668334

Technical Information Center: 1-800-521-6274

HOME PAGE: <http://www.motorola.com/semiconductors>



**For More Information On This Product,
Go to: www.freescale.com**

MRF374A/D