

15 AMPS. GLASS PASSIVATED  
SILICON BRIDGE RECTIFIERS

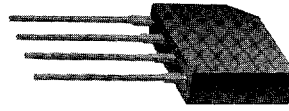

VOLTAGE RANGE  
50 to 1000 Volts  
CURRENT  
1.5 Amperes

**FEATURES**

- Rating to 1000V PRV
- Surge overload rating to 40 Amperes peak
- Ideal for printed circuit board
- Reliable low cost construction utilizing molded plastic technique results in inexpensive product
- Lead solderable per MIL-STD-202 Method 208
- Leads: Tin plated copper
- Plastic material has U/L flammability classification 94V-0
- Weight: 0.05 ounce 1.52 grams

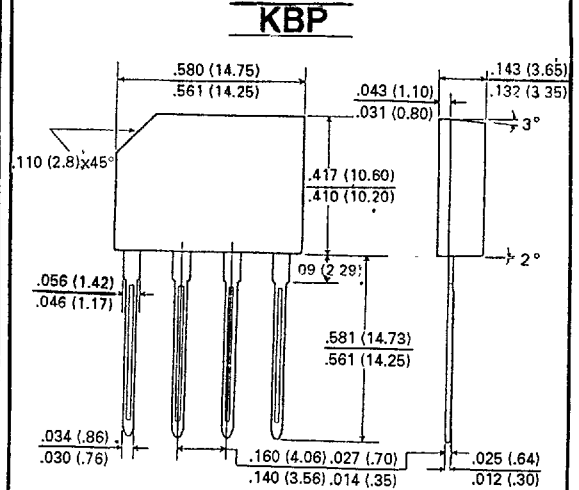

**MAXIMUM RATINGS AND ELECTRICAL CHARACTERISTICS**

Ratings at 25° C ambient temperature unless otherwise specified.  
Single phase, half wave, 60Hz, resistive or inductive load,  
For capacitive load, derate current by 20%.

		KBP005G	KBP01G	KBP02G	KBP04G	KBP06G	KBP08G	KBP10G	UNITS
Maximum Recurrent Peak Reverse Voltage	$V_{RRM}$	50	100	200	400	600	800	1000	V
Maximum RMS Bridge Input Voltage	$V_{RMS}$	35	70	140	280	420	560	700	V
Maximum DC Blocking Voltage	$V_{DC}$	50	100	200	400	600	800	1000	V
Maximum Average Forward Output Current @ $T_A = 75^\circ C$	$I_{(AV)}$	1.5							A
Peak Forward Surge Current 8.3 ms single half sine-wave superimposed on rated load (JEDEC Method)	$I_{FSM}$	40							A
Maximum DC Forward Voltage drop per element at 1.5 A DC	$V_F$	1.1							V
Maximum DC Reverse Current at rated @ $T_A = 25^\circ C$ DC Blocking Voltage per element @ $T_A = 125^\circ C$	$I_R$	5 500							$\mu A$ $\mu A$
Typical Junction Capacitance (Note 1)	$C_J$	20							pF
Typical Thermal Resistance (Note 2)	$R_{\theta JC}$	18							° C/W
Operating Temperature Range	$T_J$	-55 to + 150							° C
Storage Temperature Range	$T_{STG}$	-55 to + 150							° C

NOTE:

1. Measured at 1.0 MHz and applied reverse voltage of 4.0V DC.
2. Thermal Resistance Junction to Case.

FIG. 1—FORWARD CURRENT DERATING CURVE

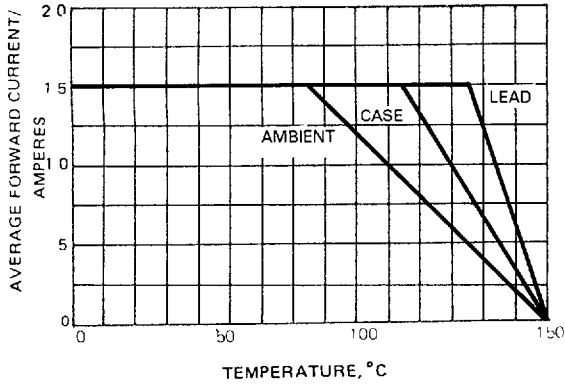

FIG 2 - MAXIMUM NON-REPETITIVE PEAK FORWARD SURGE CURRENT

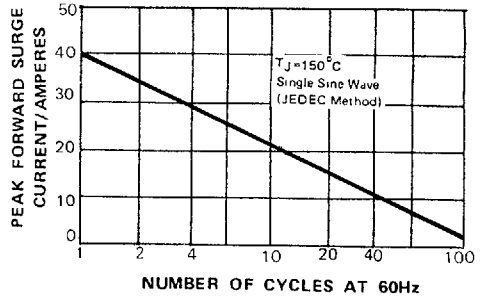

FIG. 3— TYPICAL FORWARD CHARACTERISTIC

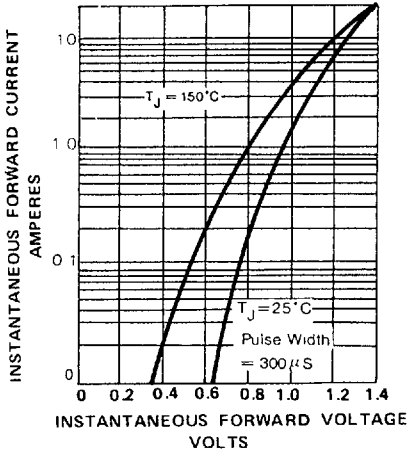

FIG 5 TYPICAL REVERSE CHARACTERISTIC

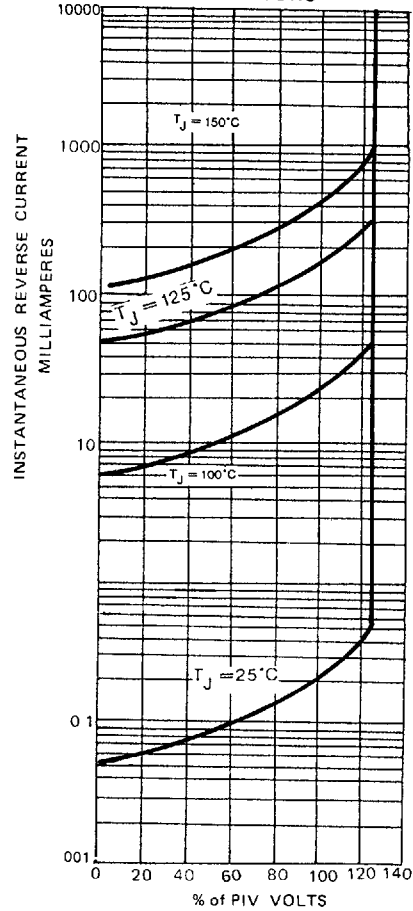
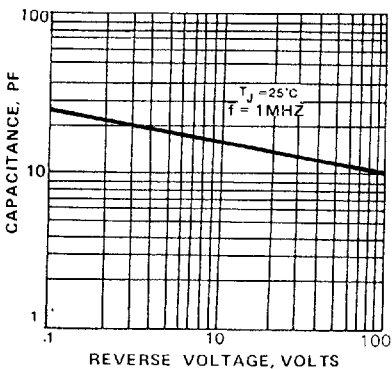

FIG 4— TYPICAL JUNCTION CAPACITANCE



## Embossed Carrier Dimensions

8, 12, 16, 24mm Tape Only

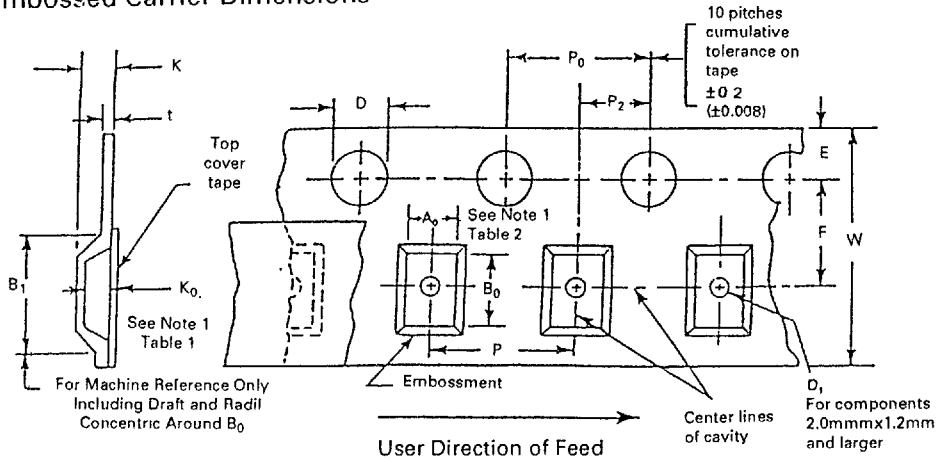

TABLE 1

**EMBOSSSED TAPE**

ALL DIMENSION IN MILLIMETERS AND (INCHES)

TAPE SIZE	D	E	Po	t (MAX)	AoBoKo	CONSTANT DIMENSION
12.16 mm	$1.5^{+0.10}_{-0.0}$ (0.059 <sup>+0.004</sup> <sub>-0.00</sub> )	$1.75 \pm 0.10$ (0.069 ± 0.04)	$4.0 \pm 0.10$ (0.157 ± 0.04)	0.40 (0.016)	SEE NOTE 1	

PRODUCT TYPE	TAPE SIZE	B1 MAX	D1 MIN	F	K MAX	P2	R MIN	M	P	VARIABLE DIMENSIONS
SM1	12mm	8.2 (.323)	1.5 (.059)	$5.5 \pm 0.05$ (.217 ± .002)	4.5 (.177)	$2.0 \pm 0.05$ (.079 ± .002)	30 (1.81)	$12.0 \pm .30$ (.472 ± .012)	$4.0 \pm .10$ (.157 ± .004)	
SMB					2.67 (.105)				$8.0 \pm .10$ (.315 ± .004)	
DFS	16mm	12.1 (.476)	1.5 (.059)	$7.5 \pm 0.10$ (.295 ± .004)	3.7 (.146)	$4.0 \pm .10$ (.157 ± .004)	30 (1.81)	$16.0 \pm .30$ (.630 ± .012)	$12.0 \pm .10$ (.472 ± .004)	
SMDF					4.9 (.193)				$6.0 \pm .10$ (.287 ± .004)	

Notes: 1. AoBoKo are determined by component size. The clearance between the component and the cavity must be within 0.05 (.002) min. to 0.50 (.020) max. for 8mm tape. 0.05 (.002) min. to 0.65 (.025) max. for 12mm tape. 0.05 (.002) min. to 0.90 (.035) max. for 16mm tape and 0.05 (.002) min. to 1.00 (.039) max. for 24mm tape and larger. The component cannot rotate more than 20° within the determined cavity, see sketch "A" below.

2. Tape and components shall pass around radius "R" without damage.

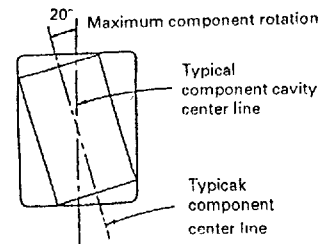

Sketch "A"

# SURFACE MOUNT PACKAGING

Packed per EIA/JEDEC Standard RS-481

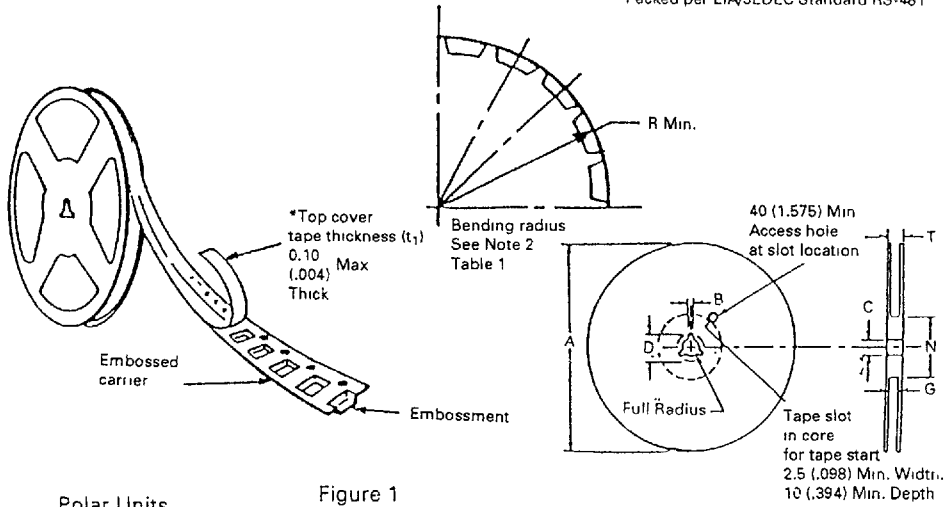

Polar Units

Figure 1

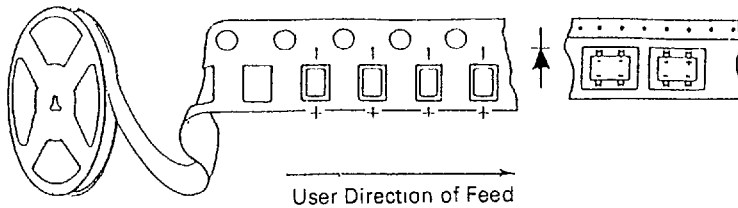

## REEL DIMENSIONS

TAPE SIZE	A MAX.	B MAX.	C	D MIN	N MIN	G	T MAX.
12mm	330 (12.992)	1.5 (.059)	13.0±0.5 (.512±.020)	20.2 (.795)	5.0 (1.969)	12.4 <sup>+2.0</sup> <sub>-0.0</sub> (.488 <sup>+0.078</sup> <sub>-0.0</sub> )	18.4 (.724)
16mm	360 (14.173)	1.5 (.059)	13.0±0.5 (.512±.020)	20.2 (.795)	5.0 (1.969)	16.4 <sup>+2.0</sup> <sub>-0.0</sub> (.646 <sup>+0.078</sup> <sub>-0.0</sub> )	22.4 (.882)

## PACKING:

DEVICE TYPE	Q'TY/REEL (PCCS)	REEL DIA. (Mmm)	BOX SIZE (mm)	Q'TY/BOX	CARTON SIZE (mm)	Q'TY/CARTON (PCS)
SMI	1500	178	188x188x68	6000	337x337x350	30000
	5000	330	337x337x40	10000		80000
SMB	500	175	188x188x68	1000		14000
	3000			6000		48000
DF-S	1000	330	337x337x40	1000		8000
S MDF						

Axial lead devices are packed in accordance with EIA standard RS-296-D and specifications given below.

COMPONENT OUTLINE	COMPONENT PITCH A ±0.5mm (.020")	INNER TAPE PITCH B ±1.5mm (.059")	CUMULATIVE PITCH TOLERANCE
A-405	5.0mm	26.0mm	2.0mm/20pitch
A-405	5.0mm	52.4mm	2.0mm/10pitch
DO-41	5.0mm	26.0mm	2.0mm/20pitch
DO-41	5.0mm	52.4mm	2.0mm/10pitch
DO 15	5.0mm	52.4mm	2.0mm/10pitch
DO-201AD	10.0mm	52.4mm	2.0mm/10pitch
R-6	10.0mm	52.4mm	2.0mm/10pitch

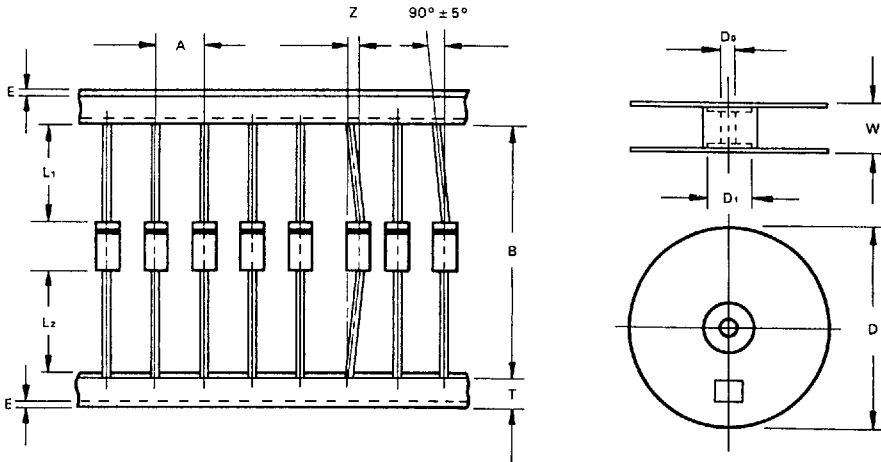

ITEM	SYMBOL	SPECIFICATIONS (mm)	SPECIFICATIONS (inch)
Component alignment	Z	1.2 max.	0.048 max.
Tape width	T	6.0±0.4	0.236±0.016
Exposed adhesive	E	0.8 max.	0.032 max.
Body eccentricity	$ L_1 - L_2 $	1.0 max.	0.040 max.
Reel outside diameter	D	330.0	13.0
Reel inner diameter	$D_1$	85.7±0.3	3.375±0.012
Feed hole diameter	$D_0$	16.6±0.4	0.655±0.016
Reel width	W	79.0±1.0	3.110±0.040

NOTE. 1. Each component lead shall be sandwiched between tapes for a minimum of 3.2mm (0.126").  
 2. The reel width 'W' for 26mm taping is 50.0 ± 1.0mm (1.97" ± 0.040")

**BULK PACKAGING**

DEVICE TYPE	PACKAGING SIZE (MM)		QUANTITY (EA)		APPROX GROSS WEIGHT (KG)	
	BOX	CARTON	BOX	CARTON	BOX	CARTON
DO 41L	196 x 84 x 20	450 x 210 x 250	1000	50K	0.38	20
DO-41 DO-15	196 x 84 x 20	450 x 210 x 250	1000	50K	0.38	20
DO-201AD	305 x 93 x 59	355 x 355 x 355	1000	20K	1.35	28
R-6	305 x 93 x 59	355 x 355 x 355	500	10K	1.2	24.5
PBM	238 x 235 x 50	500 x 250 x 290	1000	10K	1.5	16.2
PBDF /DF	495 x 155 x 145	500 x 325 x 305	5000	20K	7.1	28.4
PBP	220 x 170 x 55	450 x 210 x 310	400	4K	1.1	11
PBL	238 x 235 x 50	500 x 250 x 290	300	3K	1.9	19.5
PBPC-3/PBPC-6	205 x 205 x 55	450 x 210 x 310	200	2K	0.9	8.9
PBPC-8	200 x 200 x 55	450 x 210 x 310	150	1.5K	1.7	7.5
KBPC/MP	205 x 205 x 55	450 x 210 x 310	50	0.5K	1.9	16
KBPC W/MP W		340 x 330 x 280	100	0.8K	3.5	28
TO-220	555 x 165 x 95	570 x 355 x 215	2000	8K	5.8	24
TO-3P	550 x 200 x 120	570 x 230 x 265	1200	2.4K	11	23
SMDF /DF-S	495 x 155 x 145	500 x 325 x 305	9000	36K	6.5	26.5

**AMMO BOX PACKAGING**

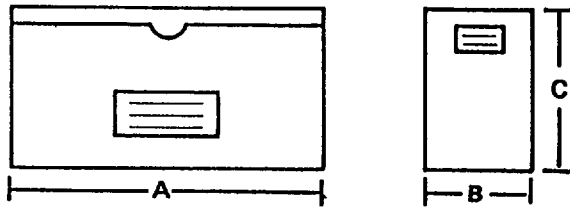

**BOX SIZE**

Unit: m. m.

Packaging	Products Outline	Dimension "A"	Dimension "B"	Dimension "C"	Q'ty per BOX
26MM Horizontal Ammo Pack	DO-41, T-1, A-405	255	50	107	3K
52MM Horizontal Ammo Pack	DO-41, A-405, T-1 DO-15, DO-201AD	250	75	107	3K 2K 1K

**CARTON SIZE**

Unit: m. m.

Packaging	Products Outline	Length	Width	Height	Q'ty Per Carton
26MM Horizontal Ammo Pack	DO-41, T-1, A-405	530	300	280	54K
52MM Horizontal Ammo Pack	DO-41, A-405, T-1 DO-15, DO-201AD	530	300	280	36K 24K 12K

## PANASERT PACKAGE

- LITE-ON supplies panasert taping/packing to satisfy customer requirement
- All dimensions follow EIA-481 standard

Products	QTY/Reel	QTY/Ammo Box
A-405	2.5K	2K

### PANASERT PACKAGING OUTLINES

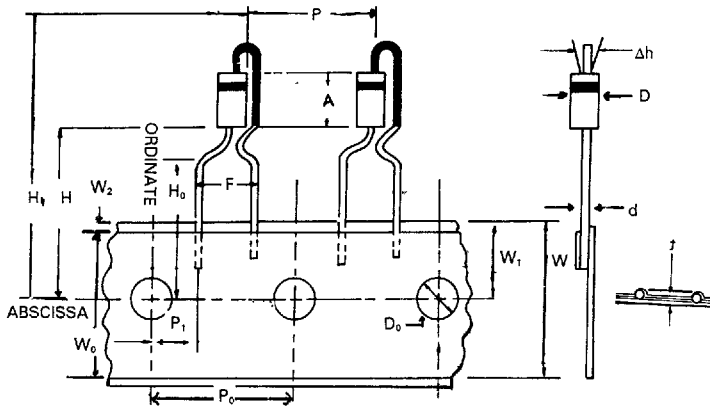

#### PACKING:

- Maximum fanfold (Ammunition box): 340 x 340 x 55 mm
- Maximum reel size: 360mm diameter x 55 mm overall width:
- Packaging method code:
  1. Cathode up, anode first off ammo pack
  2. Cathode up, cathode first off ammo pack
  3. Cathode up, anode first off reel
  4. Cathode up, cathode first off reel
  5. Cathode down, anode first off ammo pack
  6. Cathode down, cathode first off ammo pack
  7. Cathode down, anode first off reel
  8. Cathode down, cathode first off reel

ITEM	SYMBOL	A-405 mm (INCH)
Body height	A	5.2 (0.205) max.
Body diameter	D	2.7 (0.107) max.
Lead wire diameter	d	0.59±0.05 (0.023±0.002)
Pitch of component	P	12.7±1.0 (0.500±0.01)
Sprocket hole pitch	P <sub>0</sub>	12.7±1.0 (0.500±0.04)
Sprocket hole center to lead	P <sub>1</sub>	3.85±0.70 (0.152±0.028)
Carrier tape width	W	18.0±0.5 (0.709±0.020)
Hold down tape width	W <sub>0</sub>	12.5±1.0 (0.492±0.014)
Sprocket hole position	W <sub>1</sub>	9.0± <sup>0.75</sup> / <sub>0.50</sub> (0.351± <sup>0.03</sup> / <sub>0.02</sub> )
Hold down tape position	W <sub>2</sub>	0.6 (0.024) max.
Sprocket hole diameter	D <sub>0</sub>	4.0±0.2 (0.157±0.008)
Height of component from tape position	H	19.5±1.0 (0.768±0.040)
Lead wire clinch height	H <sub>0</sub>	16.0±0.5 (0.630±0.020)
Overall height above abscissa	H <sub>1</sub>	32.25 (1.27) max.
Component lead spacing	F	5.0±0.5 (0.197±0.020)
Total tape thickness	t	1.5 (0.059) max.
Deflection	Δh	±1.0 (±0.040)

- NOTE: 1. Lead insulation coating allow to be exposed 1.5 mm (0.059 inch) max. from body.  
 2. Non insulation lead coating type is also available.  
 3. Lead protrusion shall not exceed 0.6mm (0.024) max.

PREFORMED LEAD DRAWING

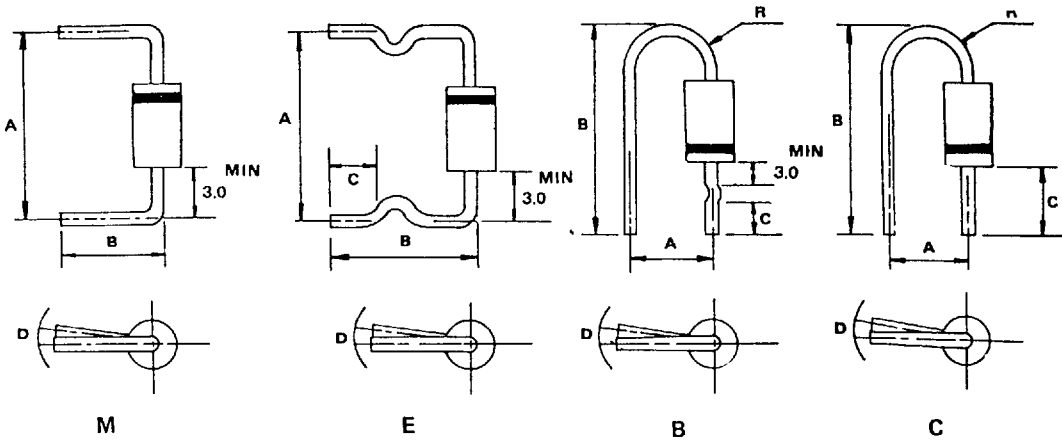

Case type	Performed Type	A -(mm)		B -(mm)		C -(mm)		D -(mm)		R (M00)	
		range	tolerance	range	tolerance	range	tolerance	range	tolerance	range	tolerance
DO-41 DO-41L	M	9.0-20.0	±0.5	8.0-22.0	±0.5	-	-	1.5	max.	-	-
	E	11.0-20.0	±0.5	11.0-16.0	±1.0	4.0-5.0	±0.5	1.5	max.	-	-
	B	7.5	±0.5	19.0-22.0	±0.5	7.5	±0.5	1.5	max.	2.5-4.0	Typ
	C	4.5	±0.8	18.0-19.0	±0.5	9.0	±0.5	1.5	max.	2.5-4.0	Typ
DO-15	M	9.0-20.0	±0.5	8.0-22.0	±0.5	-	-	1.5	max.	-	-
	E	11.0-20.0	±0.5	11.0-16.0	±1.0	4.0-5.0	±0.5	1.5	max.	-	-
DO201AD	M	15.0-20.0	±1.0	8.0-22.0	±1.0	-	-	2.0	max.	-	-
	E	15.0-20.0	±1.0	10.0-22.0	±1.0	3.0-15.0	±0.5	2.0	max.	-	-
R-6	M	15.0-20.0	±1.0	8.0-22.0	±1.0	-	-	2.0	max.	-	-

\*Press Forming Also Available.