



Description

The Bay Linear LP2950 and LP2951 are low power voltage regulators. They are excellent choice for use in Battery Powered applications such notebooks computers. The LP2950 and LP2951 feature low quiescent current (75 μ A Typ.) and low dropout of 40mV at light loads 380mV (typ.) at 100mA. With a tight initial tolerance of 0.5% typ., extremely good load and line regulation of 0.05% typ. And very low output temperature coefficient making the LP2950 and LP2951 useful as a low power reference.

The Bay Linear LP2950 is available in fixed voltages of 3.0V, 3.3V, and 5.0V in a TO-92 package.

The Bay Linear LP2951 comes in an 8SOIC package and has an adjustable output voltage from 1.24V to 29V programmed with a pair of external resistor. It also features pin-strap capability providing the fixed voltage of 3.0, 3.3V or 5V for convenience. The LP2951 has an error flag output feature used as power-on reset for warning of low output voltage due to falling battery voltages. Also, the logic compatible shutdown input enables the regulator to be switched ON and OFF.

Features

- **Guaranteed 100mA Output**
- **5.0V, 3.3V and 3.0V Versions**
- **Very Low Quiescent Current**
- **Low Dropout Voltage**
- **Extremely Tight Load and Line Regulation**
- **Very Low Temperature Coefficient**
- **Needs only 1 μ F for Stability**
- **Error Flag warns of output dropout**
- **Logic-Controlled Electronic Shutdown**
- **Output programmable from 1.24V to 29V**

Applications

- **Battery Powered Systems**
- **Portable instrumentation**
- **Notebooks Computers**
- **Potable Consumer Equipment**
- **Automotive electronics**
- **SMPS Post-Regulator**

Pin Connection

TO-92 (Z)

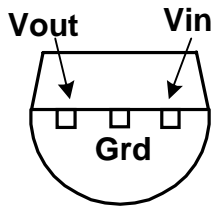

8SOIC (M)

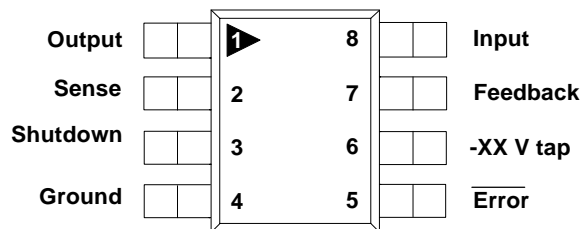

Ordering Information

Package	Tolerance	
	0.5%	1%
TO-92	LP2950AZ-XX	LP2950-BZ-XX
8SOIC	LP2951AM-XX	LP2951BM-XX

“XX” Voltage Selection Guide

Vout	XX Code
5.0V	5
3.3V	3.3
3.0V	3
Adjustable	Left Blank

Absolute Maximum Rating

Parameter	
Power Dissipation	Internally Limited
Lead Temperature (Soldering 5 seconds)	260 °C
Storage Temperature Range	-65 °C to +150 °C
Operating Junction Temperature	-55 °C to +150 °C
Input Supply Voltage	-0.3V to +30V
Feedback Input Voltage	-1.5V to +30V
Shutdown Input Voltage	-0.3V to +30V
Error Comparator Output	-0.3V to +30V

Electrical Characteristics

($V_S = 15V$, $T_A = 25^\circ C$, unless otherwise specified)

Parameter	Conditions	MIN	TYP	MAX	UNIT
Output Voltage	$-25^\circ C \leq T_j \leq 85^\circ C$ Full Operating Temperature	0.985 [V_O] 0.98 [V_O]	V_O	1.015 [V_O] 1.02 [V_O]	V
Output Voltage	$100\mu A \leq I_L \leq 100mA$, $T_j \leq T_{jmax}$	0.976 [V_O]	V_O	1.024 [V_O]	V
Output Voltage Temperature Coefficient	(Note 1)		50	150	ppm / °C
Line Regulation (Note 3)	$V_O + 1V \leq V_{IN} \leq 30V$ (Note 4)		0.04	0.4	%
Load Regulation (Note 5)	$100\mu A \leq I_L \leq 100mA$		0.1	0.3	%
Dropout Voltage	$I_L = 100\mu A$ $I_L = 100mA$		50 380	80 450	mV
Ground Current	$I_L = 100\mu A$ $I_L = 100mA$		75 8	120 12	μA mA
Dropout Ground Current	$V_{IN} = V_O - 0.5V$, $I_L = 100\mu A$		110	170	μA
Current Limit	$V_{OUT} = 0$		160	200	mA
Thermal Regulation			0.05	0.2	% / W
Output Noise, 10Hz to 100KHz	$C_L = 1\mu F$ $C_L = 200\mu F$ $C_L = 3.3\mu F$ (Bypass = 0.01 μF pins 7 to 1 for LP2951-XX)		430 160 100		μV_{rms}
8 pin Versions only (LP2951)					
Reference Voltage	Over temperature	1.21 1.185	1.235	1.26 1.285	V
Feedback Pin Bias Current			20	40	ηA
Reference Voltage Temperature Coefficient	(Note 7)		50		ppm/°C
Feedback Pin Bias Current Temperature Coefficient			0.1	100	$\eta A/^\circ C$
Error Comparator					
Output Leakage Current	$V_{OH} = 30V$		0.01	1.0	μA
Output Low Voltage	$V_{IN} 4.5V$, $I_{OL} = 400\mu A$		150	250	mV
Upper Threshold Voltage	(Note 8)	40	60		mV
Lower Threshold Voltage	(Note 8)		75	95	mV
Hysteresis	(Note 8)		15		mV

APPLICATION HINTS

EXTERNAL CAPACITORS

The stability of the LP2950/LP2951 requires a 1.0µF or greater capacitor between output and ground. Oscillation could occur without this capacitor. Most types of tantalum or aluminum electrolytic works fine here. For operations below -25°C solid tantalum is recommended since many aluminum types have electrolytes that freeze at about -30°C. The ESR of about 5Ω or less and resonant frequency above 500kHz are the most important parameters in the value of the capacitor. The capacitor value can be increased without limit.

At lower values of output current, less output capacitance is required for stability. For the currents below 10mA the value of the capacitor can be reduced to 0.5µF and 0.15µF for 1mA. More output capacitance is needed for the 8-pin version at voltages below 5V since it runs the error amplifier at lower gain. At worst case 5µF or greater must be used for the condition of 150mA load at 1.23V output.

The LP2950, unlike other low dropout regulators will remain stable in regulation with no load in addition to the internal voltage divider. This feature is especially important in applications like CMOS RAM keep-alive. When setting the output voltage of the LP2951 version with external resistors, a minimum load of 1µA is recommended.

If there is more than 10 inches of wire between the input and the AC filter capacitor or if a battery is used as the input then a 1µA tantalum or aluminum electrolytic capacitor should be placed from the input to the ground.

Instability can occur if there is stray capacitance to the LP2951 feedback terminal (pin 7). This could cause more problems when using a higher value of external resistors to set the output voltage. This problem can be fixed by adding a 100pF capacitor between output and feedback and increasing the output capacitor to at least 3.3µF.

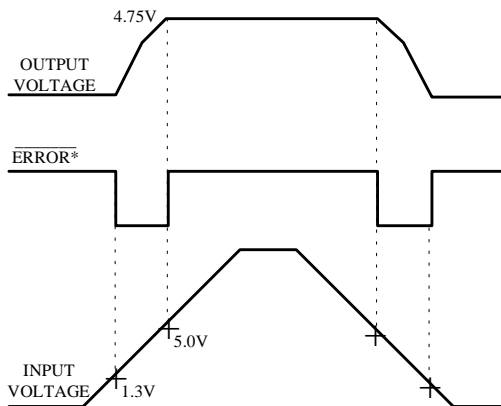

* See Application Info.

Figure 1. ERROR Output Timing

ERROR DETECTION COMPARATOR OUTPUT

The Comparator produces a logic low output whenever the LP2951 output falls out of regulation by more than around 5%.

This is around 60mV offset divided by the 1.235 reference voltage. This trip level remains 5% below normal regardless of the programmed output voltage of the regulator. Figure 1 shows the timing diagram depicting the ERROR signal and the regulator output voltage as the LP2951 input is ramped up and down. The ERROR signal becomes low at around 1.3V input, and goes high around 5V input (input voltage at which $V_{OUT} = 4.75$). Since the LP2951's dropout voltage is load dependent, the input voltage trip point (around 5V) will vary with the load current. The output voltage trip point (approx. 4.75V) does not vary with load.

The error comparator has an open-collector output which requires an external pull-up resistor. Depending on the system requirements the resistor may be returned to 5V output or other supply voltage in determining the value of this resistor, note that the output is rated to sink 400µA, this value adds to battery drain in a low battery condition. Suggested values range from 100K to 1MΩ. If the output is unused this resistor is not required.

PROGRAMMING THE OUTPUT VOLTAGE OF LP2951

The LP2951 may be pin-strapped for 5V using its internal voltage divider by tying Pin 1 (output) to Pin 2 (sense) and Pin 7 (feedback) to Pin 6 (5V Tap). Also it may be programmed for any output voltage between its 1.235V reference and its 30V maximum rating. As seen in Figure 2, an external pair of resistors is required.

Refer to the below equation for the programming of the output voltage.

$$V_{OUT} = V_{REF} \times (1 + R_1/R_2) + I_{FB}R_1$$

The V_{REF} is 1.235 and I_{FB} is the feedback bias current, nominally -20 nA. The minimum recommended load current of 1µA forces an upper limit of 1.2 MΩ on value of R_2 . If no load presented the I_{FB} produces an error of typically 2% in V_{OUT} which may be eliminated at room temperature by trimming R_1 . To improve the accuracy choose the value of $R_2 = 100k$ this reduces the error by 0.17% and increases the resistor program current by 12µA. Since the LP2951 typically draws 60µA at no load with Pin 2 open-circuited this is a small price to pay.

REDUCING OUTPUT NOISE

It may be an advantage to reduce the AC noise present at the output. One way is to reduce the regulator bandwidth by increasing the size of the output capacitor. This is the only way that noise can be reduced on the LP2950 but is relatively inefficient, as increasing the capacitor from 1µF to 220 µF only decreases the noise from 430µV to 160µV_{RMS}. for a 100kHz bandwidth at 5V output. Noise could also be reduced fourfold by a bypass capacitor across R_1 , since it reduces the high frequency gain from 4 to unity. Pick

$$C_{BYPASS} \cong 1 / 2\pi R_1 \times 200 \text{ Hz}$$

or choose 0.01µF. When doing this, the output capacitor must be increased to 3.3µF to maintain stability. These changes reduce the output noise from 430µV to 100µV_{RMS}. for a 100kHz bandwidth at 5V output. With the bypass capacitor added, noise no longer scales with output voltage so that improvements are more dramatic at higher output voltages.

TYPICAL PERFORMANCE CHARACTERISTICS

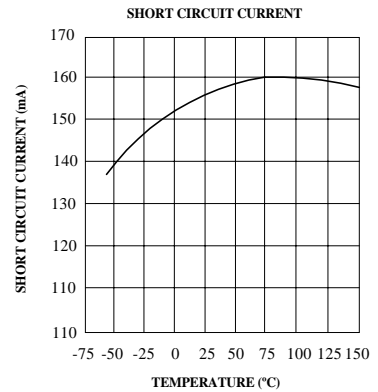
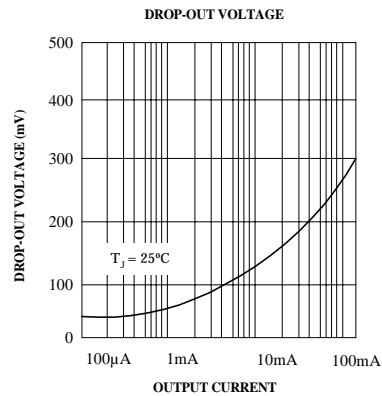
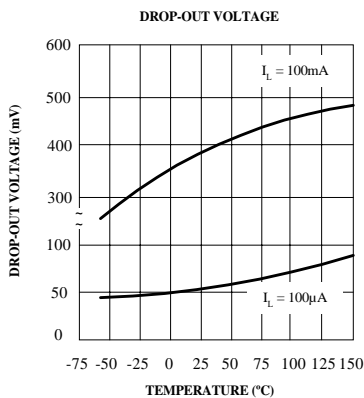
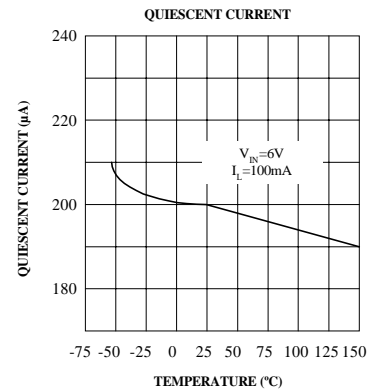
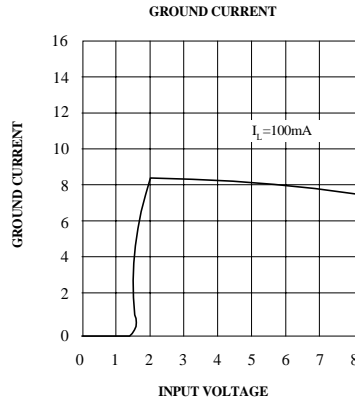
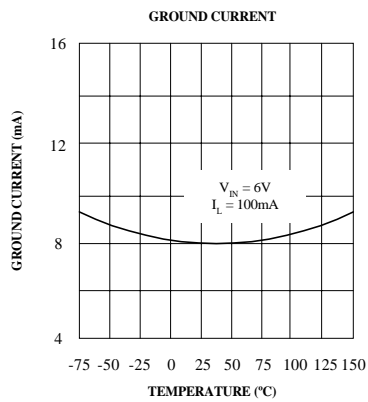
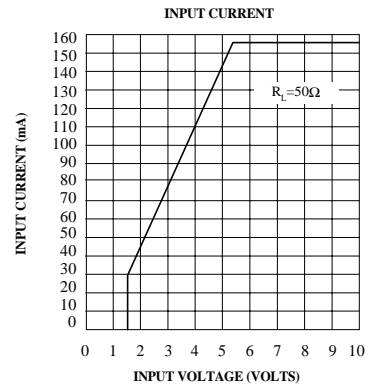
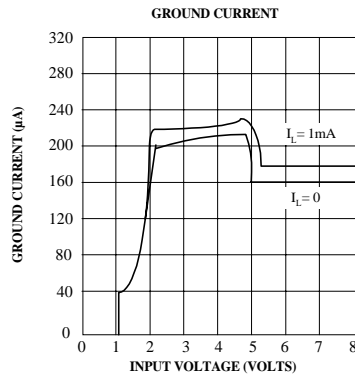
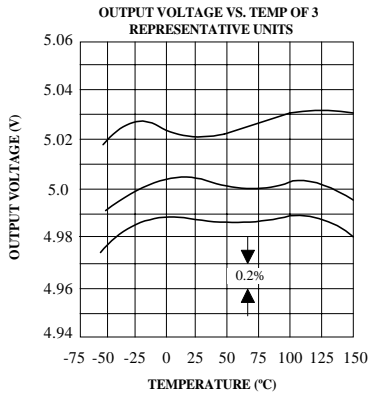
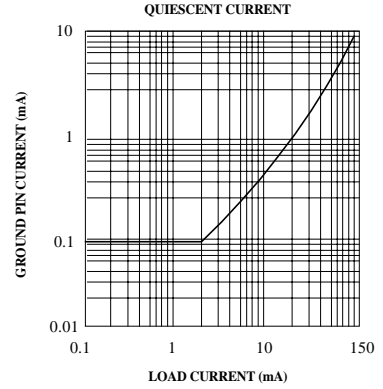
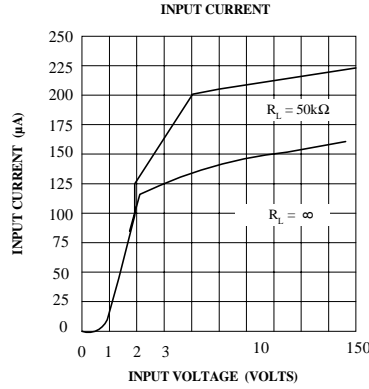
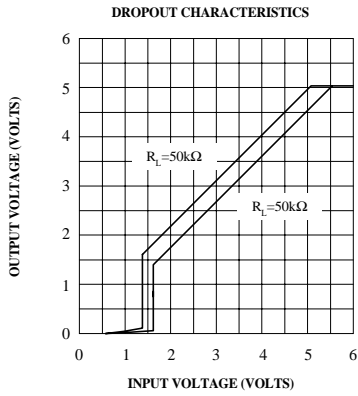

TYPICAL PERFORMANCE CHARACTERISTICS (continued)

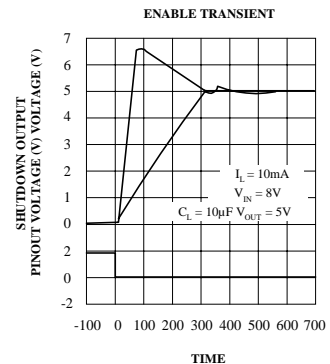
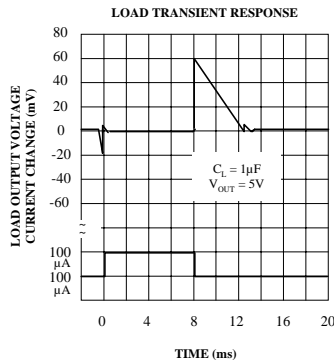
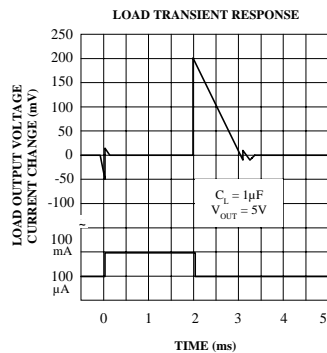
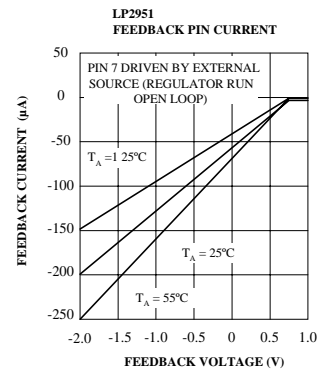
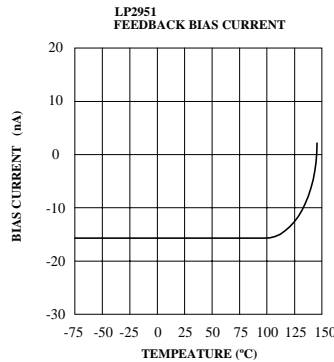
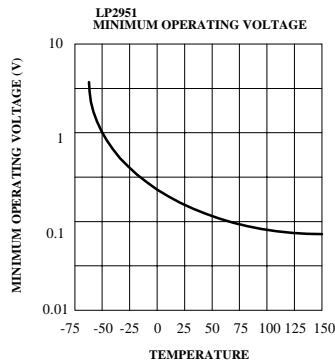
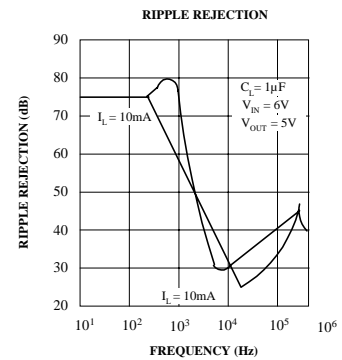
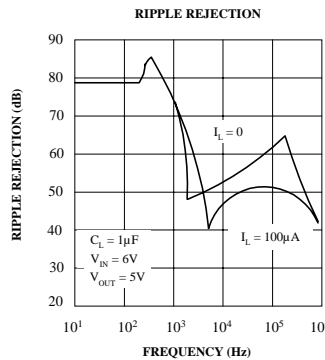
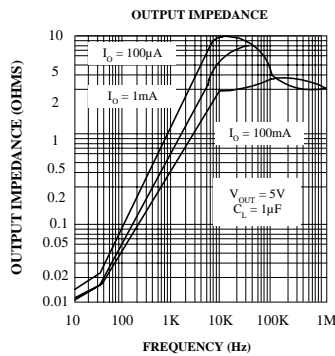
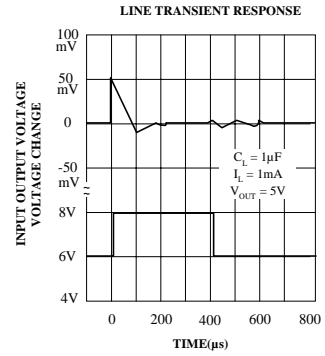
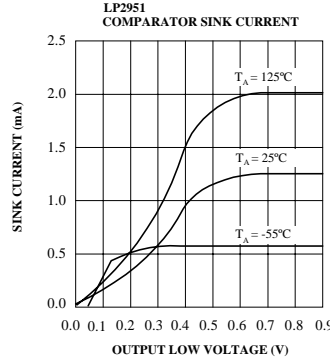
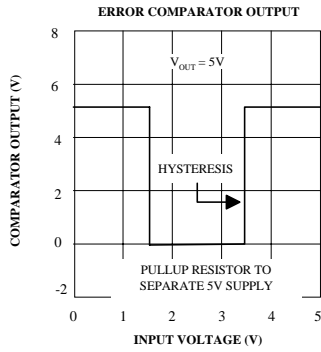

TYPICAL PERFORMANCE CHARACTERISTICS (continued)

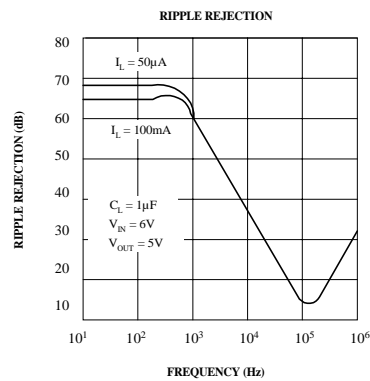
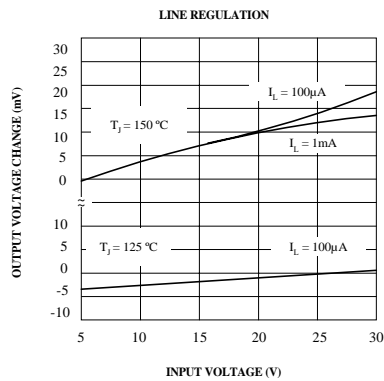
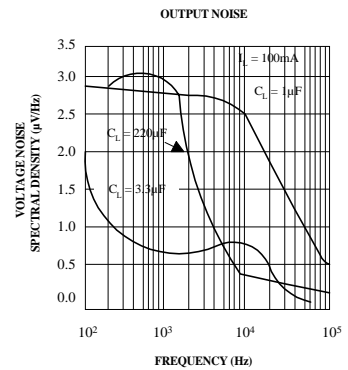
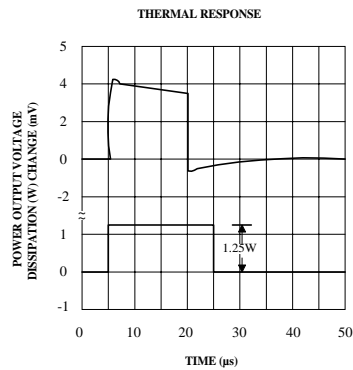
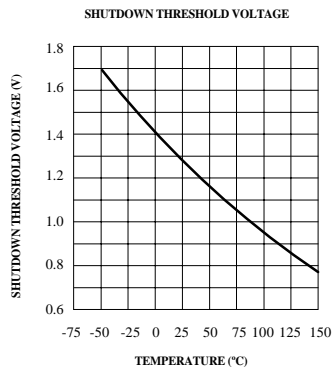
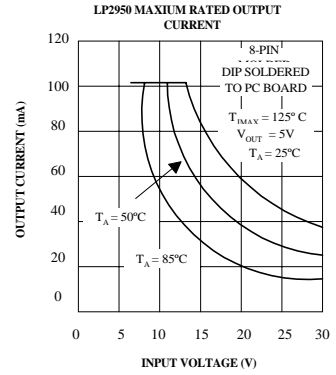
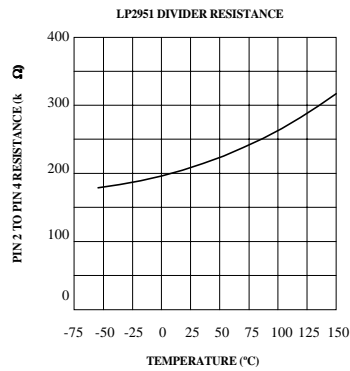
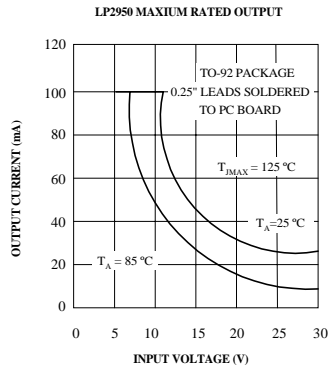

TYPICAL APPLICATIONS (continued)

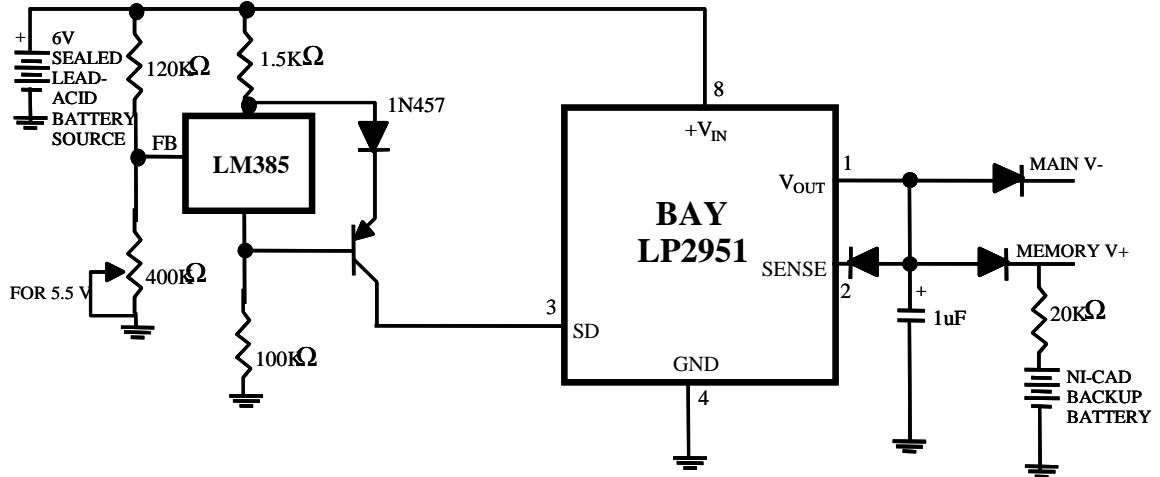

Low Battery Disconnect

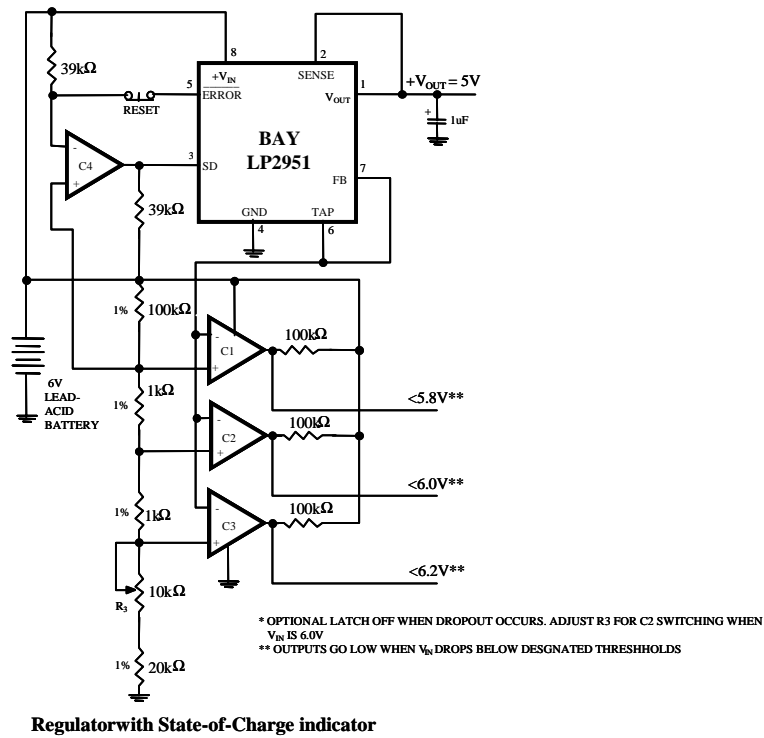

Regulator with State-of-Charge indicator

LP2950/LP2951

SCHEMATIC DIAGRAM

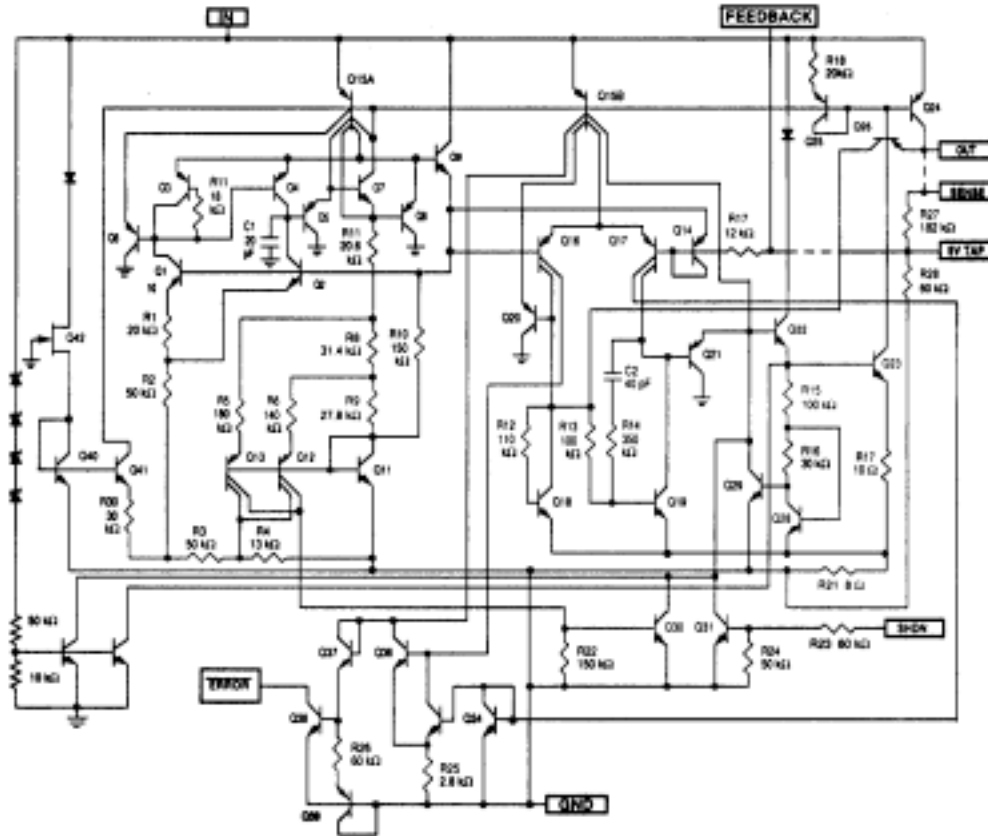

Package Drawing

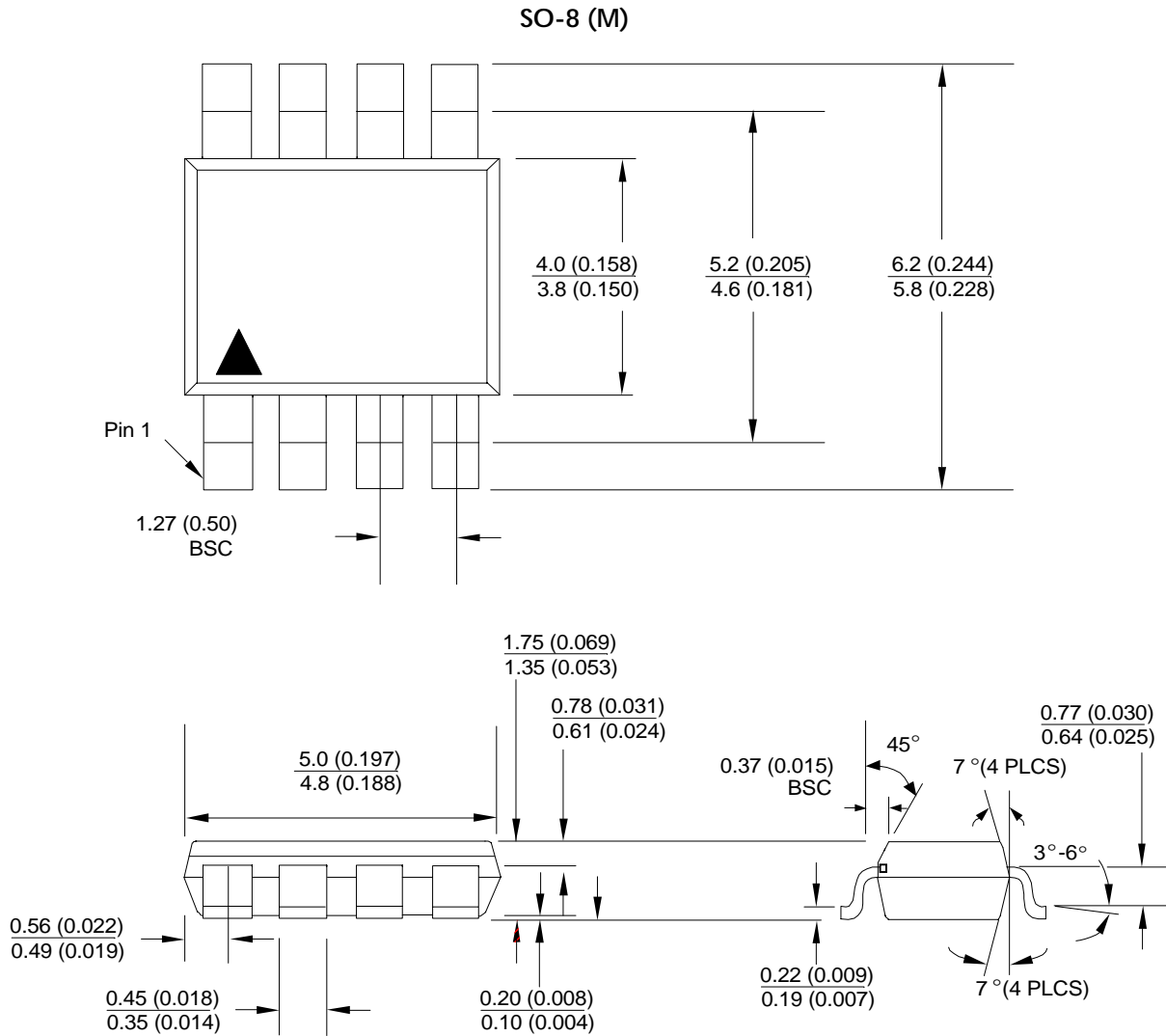

PACKAGE DRAWING

TO-92(Z)

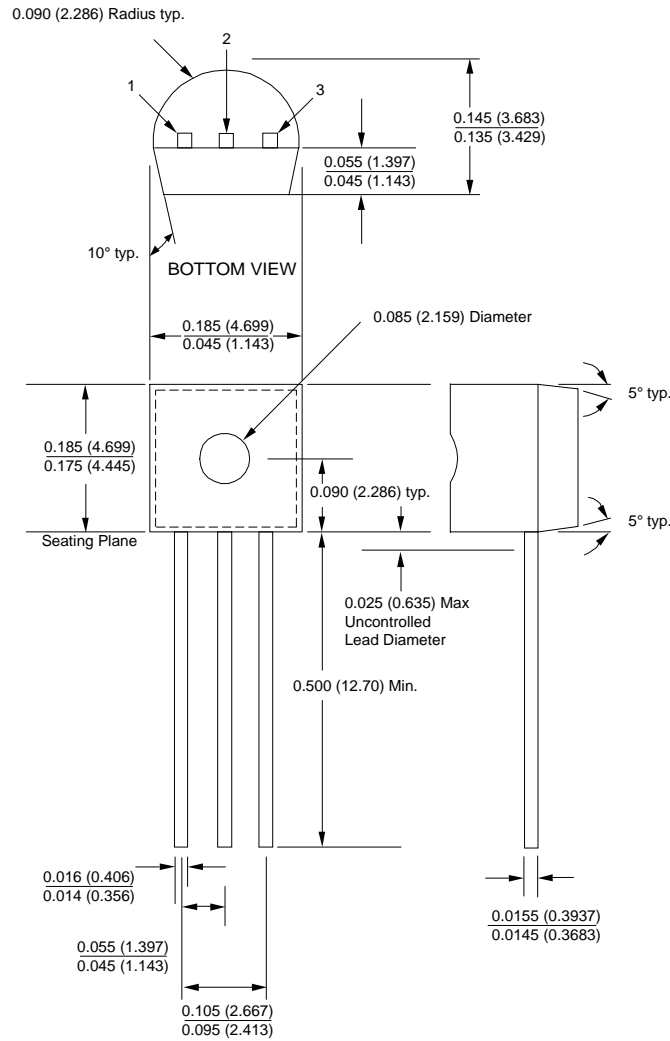

Advance Information- These data sheets contain descriptions of products that are in development. The specifications are based on the engineering calculations, computer simulations and/ or initial prototype evaluation.

Preliminary Information- These data sheets contain minimum and maximum specifications that are based on the initial device characterizations. These limits are subject to change upon the completion of the full characterization over the specified temperature and supply voltage ranges.

The application circuit examples are only to explain the representative applications of the devices and are not intended to guarantee any circuit design or permit any industrial property right to other rights to execute. Bay Linear takes no responsibility for any problems related to any industrial property right resulting from the use of the contents shown in the data book. Typical parameters can and do vary in different applications. Customer's technical experts must validate all operating parameters including "Typical" for each customer application.

LIFE SUPPORT AND NUCLEAR POLICY

Bay Linear products are not authorized for and should not be used within life support systems which are intended for surgical implants into the body to support or sustain life, in aircraft, space equipment, submarine, or nuclear facility applications without the specific written consent of Bay Linear President.