

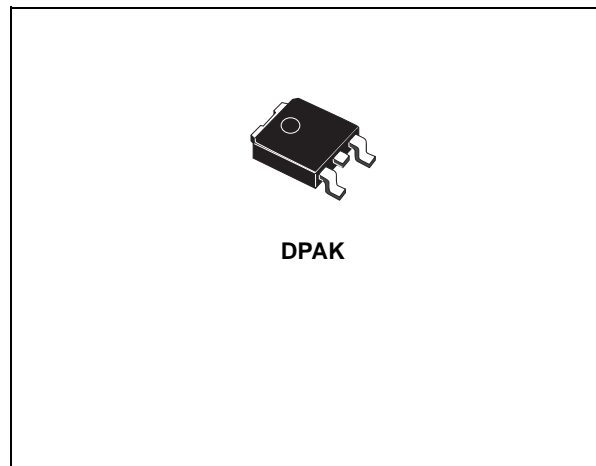

LD1085C SERIES

3A LOW DROP POSITIVE VOLTAGE REGULATOR ADJUSTABLE AND FIXED

- TYPICAL DROPOUT 1.3V (AT 3A)
- THREE TERMINAL ADJUSTABLE OR FIXED OUTPUT VOLTAGE 1.5V, 1.8V, 2.5V, 2.85V, 3.3V, 3.6V, 5V, 8V, 9V, 12V.
- GUARANTEED OUTPUT CURRENT UP TO 3A
- OUTPUT TOLERANCE $\pm 2\%$ AT 25°C AND $\pm 3\%$ IN FULL TEMPERATURE RANGE
- INTERNAL POWER AND THERMAL LIMIT
- WIDE OPERATING TEMPERATURE RANGE -40°C TO 125°C
- PACKAGE AVAILABLE : DPAK
- PINOUT COMPATIBILITY WITH STANDARD ADJUSTABLE VREG



DESCRIPTION

The LD1085 is a LOW DROP Voltage Regulator able to provide up to 3A of Output Current. Dropout is guaranteed at a maximum of 1.5V at the maximum output current, decreasing at lower loads. The LD1085 is pin to pin compatible with the older 3-terminal adjustable regulators, but has better performances in term of drop and output tolerance .

A 2.85V output version is suitable for SCSI-2 active termination. Unlike PNP regulators, where a part of the output current is wasted as quiescent current, the LD1085 quiescent current flows into the load, so increase efficiency. Only a 10 μ F minimum capacitor is need for stability. The device is supplied in DPAK. On chip trimming allows the regulator to reach a very tight output voltage tolerance, within $\pm 2\%$ at 25°C.

SCHEMATIC DIAGRAM

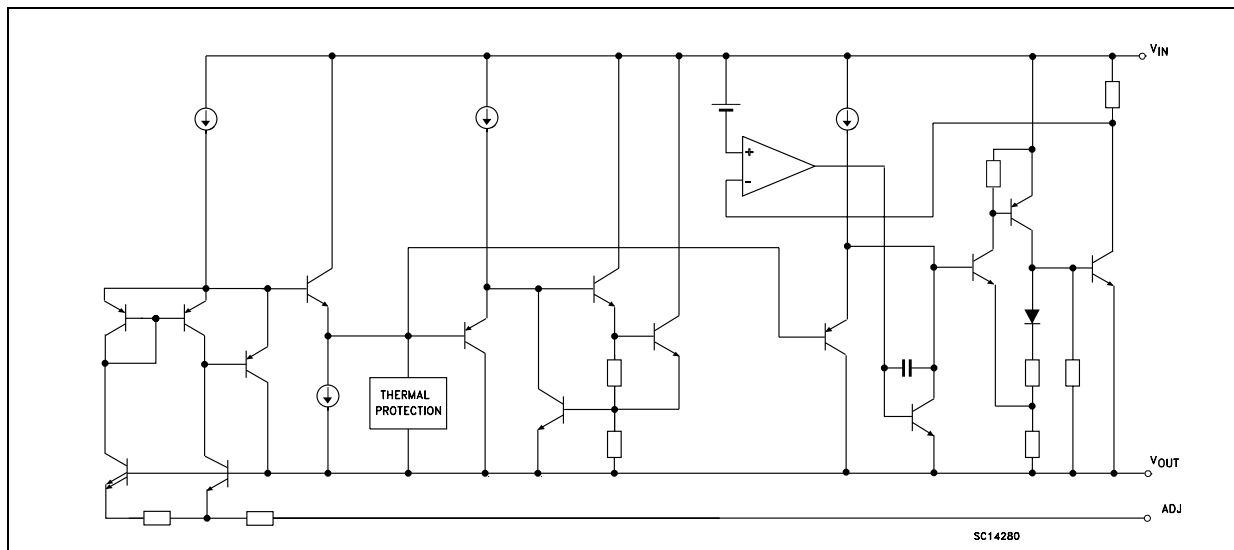

LD1085C SERIES

ABSOLUTE MAXIMUM RATINGS

Symbol	Parameter ²	Value	Unit
V_I	DC Input Voltage	30	V
I_O	Output Current	Internally Limited	mA
P_D	Power Dissipation	Internally Limited	mW
T_{stg}	Storage Temperature Range	-55 to +150	°C
T_{op}	Operating Junction Temperature Range	-40 to +125	°C

Absolute Maximum Ratings are those values beyond which damage to the device may occur. Functional operation under these condition is not implied.

THERMAL DATA

Symbol	Parameter	DPAK	Unit
$R_{thj-case}$	Thermal Resistance Junction-case	3	°C/W
$R_{thj-amb}$	Thermal Resistance Junction-ambient	62.5	°C/W

APPLICATION CIRCUITS

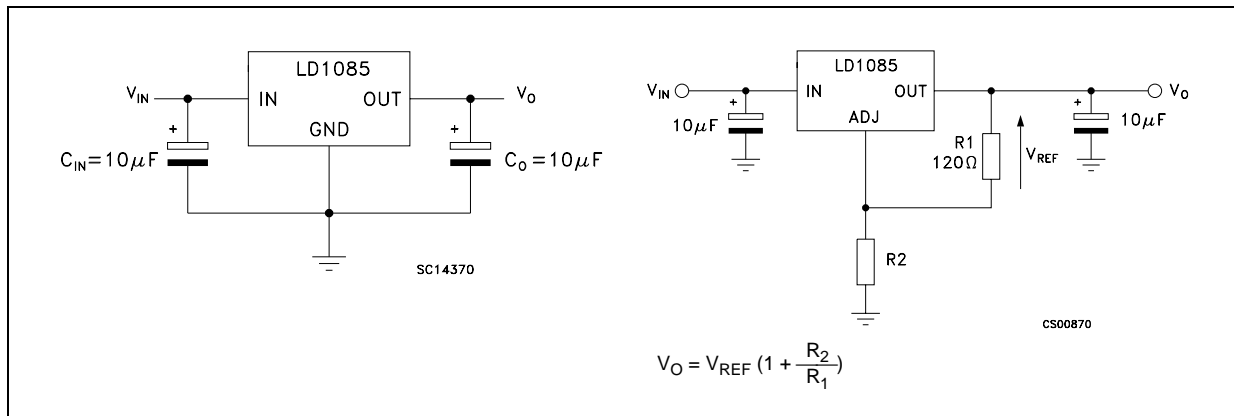

CONNECTION DIAGRAM (top view)

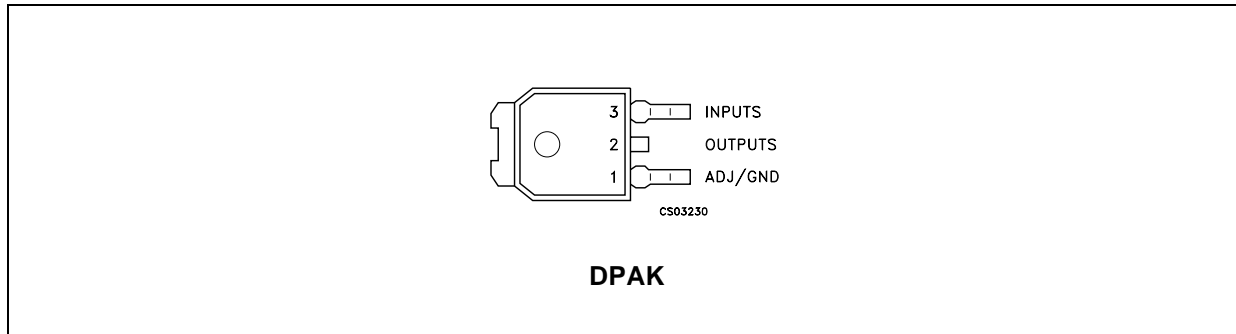

ORDERING CODES

DPAK (*)	OUTPUT VOLTAGE
LD1085CDT15	1.5 V
LD1085CDT18	1.8 V
LD1085CDT25	2.5 V
LD1085CDT28	2.85 V
LD1085CDT33	3.3 V
LD1085CDT36	3.6 V
LD1085CDT50	5.0 V
LD1085CDT80	8.0 V
LD1085CDT90	9.0 V
LD1085CDT120	12.0 V
LD1085CDT	ADJ

(*) Available in Tape & Reel with the suffix "R" for fixed version and "-R" for adjustable version.

LD1085C SERIES

ELECTRICAL CHARACTERISTICS OF LD1085CDT15 ($V_I=4.5V$, $C_I = C_O = 10\mu F$, $T_A = -40$ to $125^\circ C$, unless otherwise specified.)

Symbol	Parameter	Test Conditions	Min.	Typ.	Max.	Unit
V_O	Output Voltage	$I_O = 0$ mA $T_J = 25^\circ C$	1.47	1.5	1.53	V
		$I_O = 0$ to 3A $V_I = 3.1$ to 30V (note 1)	1.455	1.5	1.545	V
ΔV_O	Line Regulation	$I_O = 0$ mA $V_I = 3.1$ to 18V $T_J = 25^\circ C$		0.2	4	mV
		$I_O = 0$ mA $V_I = 3.1$ to 15V		0.4	4	mV
ΔV_O	Load Regulation	$I_O = 0$ to 3A $T_J = 25^\circ C$		2	10	mV
		$I_O = 0$ to 3A		4	20	V
V_d	Dropout Voltage	$I_O = 3$ A		1.3	1.5	V
I_q	Quiescent Current	$V_I \leq 30V$		5	10	mA
I_{sc}	Short Circuit Current	$V_I - V_O = 5V$	3.2	4.5		A
		$V_I - V_O = 25V$	0.2	0.5		A
	Thermal Regulation	$T_A = 25^\circ C$, 30ms pulse		0.003	0.015	%/W
SVR	Supply Voltage Rejection	$f = 120$ Hz, $C_O = 25 \mu F$, $I_O = 3A$ $V_I = 7.5 \pm 3V$	60	75		dB
eN	RMS Output Noise Voltage (% of V_O)	$T_A = 25^\circ C$ $f = 10$ Hz to 10KHz		0.003		%
S	Temperature Stability			0.5		%
S	Long Term Stability	$T_A = 125^\circ C$ 1000Hrs		0.5		%

NOTE 1: See short-circuit current curve for available output current at fixed dropout.

ELECTRICAL CHARACTERISTICS OF LD1085CDT18 ($V_I=4.8V$, $C_I = C_O = 10\mu F$, $T_A = -40$ to $125^\circ C$, unless otherwise specified.)

Symbol	Parameter	Test Conditions	Min.	Typ.	Max.	Unit
V_O	Output Voltage	$I_O = 0$ mA $T_J = 25^\circ C$	1.764	1.8	1.836	V
		$I_O = 0$ to 3A $V_I = 3.4$ to 30V (note 1)	1.746	1.8	1.854	V
ΔV_O	Line Regulation	$I_O = 0$ mA $V_I = 3.4$ to 18V $T_J = 25^\circ C$		0.2	4	mV
		$I_O = 0$ mA $V_I = 3.4$ to 15V		0.4	4	mV
ΔV_O	Load Regulation	$I_O = 0$ to 3A $T_J = 25^\circ C$		2	10	mV
		$I_O = 0$ to 3A		4	20	V
V_d	Dropout Voltage	$I_O = 3$ A		1.3	1.5	V
I_q	Quiescent Current	$V_I \leq 30V$		5	10	mA
I_{sc}	Short Circuit Current	$V_I - V_O = 5V$	3.2	4.5		A
		$V_I - V_O = 25V$	0.2	0.5		A
	Thermal Regulation	$T_A = 25^\circ C$, 30ms pulse		0.003	0.015	%/W
SVR	Supply Voltage Rejection	$f = 120$ Hz, $C_O = 25 \mu F$, $I_O = 3A$ $V_I = 7.5 \pm 3V$	60	75		dB
eN	RMS Output Noise Voltage (% of V_O)	$T_A = 25^\circ C$ $f = 10$ Hz to 10KHz		0.003		%
S	Temperature Stability			0.5		%
S	Long Term Stability	$T_A = 125^\circ C$ 1000Hrs		0.5		%

NOTE 1: See short-circuit current curve for available output current at fixed dropout.

ELECTRICAL CHARACTERISTICS OF LD1085CDT25 ($V_I=5.5V$, $C_I = C_O = 10\mu F$, $T_A = -40$ to $125^\circ C$, unless otherwise specified.)

Symbol	Parameter	Test Conditions	Min.	Typ.	Max.	Unit
V_O	Output Voltage	$I_O = 0$ mA $T_J = 25^\circ C$	2.45	2.5	2.55	V
		$I_O = 0$ to 3A $V_I = 4.1$ to 30V (note 1)	2.425	2.5	2.575	V
ΔV_O	Line Regulation	$I_O = 0$ mA $V_I = 4.1$ to 18V $T_J = 25^\circ C$		0.2	5	mV
		$I_O = 0$ mA $V_I = 4.1$ to 18V		0.4	5	mV
ΔV_O	Load Regulation	$I_O = 0$ to 3A $T_J = 25^\circ C$		2	10	mV
		$I_O = 0$ to 3A		4	20	V
V_d	Dropout Voltage	$I_O = 3$ A		1.3	1.5	V
I_q	Quiescent Current	$V_I \leq 30V$		5	10	mA
I_{sc}	Short Circuit Current	$V_I - V_O = 5V$	3.2	4.5		A
		$V_I - V_O = 25V$	0.2	0.5		A
	Thermal Regulation	$T_A = 25^\circ C$, 30ms pulse		0.008	0.04	%/W
SVR	Supply Voltage Rejection	$f = 120$ Hz, $C_O = 25 \mu F$, $I_O = 3A$ $V_I = 7.5 \pm 3V$	60	72		dB
eN	RMS Output Noise Voltage (% of V_O)	$T_A = 25^\circ C$ $f = 10$ Hz to 10KHz		0.003		%
S	Temperature Stability			0.5		%
S	Long Term Stability	$T_A = 125^\circ C$ 1000Hrs		0.5		%

NOTE 1: See short-circuit current curve for available output current at fixed dropout.

ELECTRICAL CHARACTERISTICS OF LD1085CDT285 ($V_I=5.85V$, $C_I = C_O = 10\mu F$, $T_A = -40$ to $125^\circ C$, unless otherwise specified.)

Symbol	Parameter	Test Conditions	Min.	Typ.	Max.	Unit
V_O	Output Voltage	$I_O = 0$ mA $T_J = 25^\circ C$	2.793	2.85	2.907	V
		$I_O = 0$ to 3A $V_I = 4.5$ to 30V (note 1)	2.765	2.85	2.935	V
ΔV_O	Line Regulation	$I_O = 0$ mA $V_I = 4.5$ to 18V $T_J = 25^\circ C$		0.2	6	mV
		$I_O = 0$ mA $V_I = 4.5$ to 18V		0.5	6	mV
ΔV_O	Load Regulation	$I_O = 0$ to 3A $T_J = 25^\circ C$		3	15	mV
		$I_O = 0$ to 3A		7	20	V
V_d	Dropout Voltage	$I_O = 3$ A		1.3	1.5	V
I_q	Quiescent Current	$V_I \leq 30V$		5	10	mA
I_{sc}	Short Circuit Current	$V_I - V_O = 5V$	3.2	4.5		A
		$V_I - V_O = 25V$	0.2	0.5		A
	Thermal Regulation	$T_A = 25^\circ C$, 30ms pulse		0.008	0.04	%/W
SVR	Supply Voltage Rejection	$f = 120$ Hz, $C_O = 25 \mu F$, $I_O = 3A$ $V_I = 7.85 \pm 3V$	60	72		dB
eN	RMS Output Noise Voltage (% of V_O)	$T_A = 25^\circ C$ $f = 10$ Hz to 10KHz		0.003		%
S	Temperature Stability			0.5		%
S	Long Term Stability	$T_A = 125^\circ C$ 1000Hrs		0.5		%

NOTE 1: See short-circuit current curve for available output current at fixed dropout.

LD1085C SERIES

ELECTRICAL CHARACTERISTICS OF LD1085CDT33 ($V_I=6.3V$, $C_I = C_O = 10\mu F$, $T_A = -40$ to $125^\circ C$, unless otherwise specified.)

Symbol	Parameter	Test Conditions	Min.	Typ.	Max.	Unit
V_O	Output Voltage	$I_O = 0$ mA $T_J = 25^\circ C$	3.234	3.35	3.366	V
		$I_O = 0$ to 3A $V_I = 4.9$ to 30V (note 1)	3.201	3.35	3.399	V
ΔV_O	Line Regulation	$I_O = 0$ mA $V_I = 4.9$ to 18V $T_J = 25^\circ C$		0.5	6	mV
		$I_O = 0$ mA $V_I = 4.9$ to 18V		1	6	mV
ΔV_O	Load Regulation	$I_O = 0$ to 3A $T_J = 25^\circ C$		3	15	mV
		$I_O = 0$ to 3A		7	20	V
V_d	Dropout Voltage	$I_O = 3$ A		1.3	1.5	V
I_q	Quiescent Current	$V_I \leq 30V$		5	10	mA
I_{sc}	Short Circuit Current	$V_I - V_O = 5V$	3.2	4.5		A
		$V_I - V_O = 25V$	0.2	0.5		A
	Thermal Regulation	$T_A = 25^\circ C$, 30ms pulse		0.008	0.04	%/W
SVR	Supply Voltage Rejection	$f = 120$ Hz, $C_O = 25 \mu F$, $I_O = 5A$ $V_I = 8.3 \pm 3V$	60	72		dB
eN	RMS Output Noise Voltage (% of V_O)	$T_A = 25^\circ C$ $f = 10$ Hz to 10KHz		0.003		%
S	Temperature Stability			0.5		%
S	Long Term Stability	$T_A = 125^\circ C$ 1000Hrs		0.5		%

NOTE 1: See short-circuit current curve for available output current at fixed dropout.

ELECTRICAL CHARACTERISTICS OF LD1085CDT36 ($V_I=6.6V$, $C_I = C_O = 10\mu F$, $T_A = -40$ to $125^\circ C$, unless otherwise specified.)

Symbol	Parameter	Test Conditions	Min.	Typ.	Max.	Unit
V_O	Output Voltage	$I_O = 0$ mA $T_J = 25^\circ C$	3.528	3.6	3.672	V
		$I_O = 0$ to 3A $V_I = 5.2$ to 30V (note 1)	3.492	3.6	3.708	V
ΔV_O	Line Regulation	$I_O = 0$ mA $V_I = 5.2$ to 18V $T_J = 25^\circ C$		0.5	10	mV
		$I_O = 0$ mA $V_I = 5.2$ to 18V		1	10	mV
ΔV_O	Load Regulation	$I_O = 0$ to 3A $T_J = 25^\circ C$		3	15	mV
		$I_O = 0$ to 3A		7	20	V
V_d	Dropout Voltage	$I_O = 3$ A		1.3	1.5	V
I_q	Quiescent Current	$V_I \leq 30V$		5	10	mA
I_{sc}	Short Circuit Current	$V_I - V_O = 5V$	3.2	4.5		A
		$V_I - V_O = 25V$	0.2	0.5		A
	Thermal Regulation	$T_A = 25^\circ C$, 30ms pulse		0.008	0.04	%/W
SVR	Supply Voltage Rejection	$f = 120$ Hz, $C_O = 25 \mu F$, $I_O = 3A$ $V_I = 8.6 \pm 3V$	60	72		dB
eN	RMS Output Noise Voltage (% of V_O)	$T_A = 25^\circ C$ $f = 10$ Hz to 10KHz		0.003		%
S	Temperature Stability			0.5		%
S	Long Term Stability	$T_A = 125^\circ C$ 1000Hrs		0.5		%

NOTE 1: See short-circuit current curve for available output current at fixed dropout.

ELECTRICAL CHARACTERISTICS OF LD1085CDT50 ($V_I=8V$, $C_I = C_O = 10\mu F$, $T_A = -40$ to $125^\circ C$, unless otherwise specified.)

Symbol	Parameter	Test Conditions	Min.	Typ.	Max.	Unit
V_O	Output Voltage	$I_O = 0 \text{ mA}$ $T_J = 25^\circ C$	4.9	5	5.1	V
		$I_O = 0$ to $3A$ $V_I = 6.6$ to $30V$ (note 1)	4.85	5	5.15	V
ΔV_O	Line Regulation	$I_O = 0 \text{ mA}$ $V_I = 6.6$ to $20V$ $T_J = 25^\circ C$		0.5	10	mV
		$I_O = 0 \text{ mA}$ $V_I = 6.6$ to $20V$		1	10	mV
ΔV_O	Load Regulation	$I_O = 0$ to $3A$ $T_J = 25^\circ C$		5	20	mV
		$I_O = 0$ to $3A$		10	35	V
V_d	Dropout Voltage	$I_O = 3 \text{ A}$		1.3	1.5	V
I_q	Quiescent Current	$V_I \leq 30V$		5	10	mA
I_{sc}	Short Circuit Current	$V_I - V_O = 5V$	3.2	4.5		A
		$V_I - V_O = 25V$	0.2	0.5		A
	Thermal Regulation	$T_A = 25^\circ C$, 30ms pulse		0.008	0.04	%/W
SVR	Supply Voltage Rejection	$f = 120 \text{ Hz}$, $C_O = 25 \mu F$, $I_O = 3A$ $V_I = 10 \pm 3V$	60	72		dB
eN	RMS Output Noise Voltage (% of V_O)	$T_A = 25^\circ C$ $f = 10\text{Hz}$ to 10KHz		0.003		%
S	Temperature Stability			0.5		%
S	Long Term Stability	$T_A = 125^\circ C$ 1000Hrs		0.5		%

NOTE 1: See short-circuit current curve for available output current at fixed dropout.

ELECTRICAL CHARACTERISTICS OF LD1085CDT80 ($V_I=11V$, $C_I = C_O = 10\mu F$, $T_A = -40$ to $125^\circ C$, unless otherwise specified.)

Symbol	Parameter	Test Conditions	Min.	Typ.	Max.	Unit
V_O	Output Voltage	$I_O = 0 \text{ mA}$ $T_J = 25^\circ C$	7.84	8	8.16	V
		$I_O = 0$ to $3A$ $V_I = 9.8$ to $30V$ (note 1)	7.76	8	8.24	V
ΔV_O	Line Regulation	$I_O = 0 \text{ mA}$ $V_I = 9.8$ to $20V$ $T_J = 25^\circ C$		1	18	mV
		$I_O = 0 \text{ mA}$ $V_I = 9.8$ to $20V$		2	18	mV
ΔV_O	Load Regulation	$I_O = 0$ to $3A$ $T_J = 25^\circ C$		8	30	mV
		$I_O = 0$ to $3A$		12	60	V
V_d	Dropout Voltage	$I_O = 3 \text{ A}$		1.3	1.5	V
I_q	Quiescent Current	$V_I \leq 30V$		5	10	mA
I_{sc}	Short Circuit Current	$V_I - V_O = 5V$	3.2	4.5		A
		$V_I - V_O = 25V$	0.2	0.5		A
	Thermal Regulation	$T_A = 25^\circ C$, 30ms pulse		0.008	0.04	%/W
SVR	Supply Voltage Rejection	$f = 120 \text{ Hz}$, $C_O = 25 \mu F$, $I_O = 3A$ $V_I = 13 \pm 3V$	54	71		dB
eN	RMS Output Noise Voltage (% of V_O)	$T_A = 25^\circ C$ $f = 10\text{Hz}$ to 10KHz		0.003		%
S	Temperature Stability			0.5		%
S	Long Term Stability	$T_A = 125^\circ C$ 1000Hrs		0.5		%

NOTE 1: See short-circuit current curve for available output current at fixed dropout.

LD1085C SERIES

ELECTRICAL CHARACTERISTICS OF LD1085CDT90 ($V_I=12V$, $C_I = C_O = 10\mu F$, $T_A = -40$ to $125^\circ C$, unless otherwise specified.)

Symbol	Parameter	Test Conditions	Min.	Typ.	Max.	Unit
V_O	Output Voltage	$I_O = 0$ mA $T_J = 25^\circ C$	8.82	9	9.18	V
		$I_O = 0$ to 3A $V_I = 11$ to 30V (note 1)	8.73	9	9.27	V
ΔV_O	Line Regulation	$I_O = 0$ mA $V_I = 11$ to 20V $T_J = 25^\circ C$		1	20	mV
		$I_O = 0$ mA $V_I = 11$ to 20V		2	20	mV
ΔV_O	Load Regulation	$I_O = 0$ to 3A $T_J = 25^\circ C$		8	30	mV
		$I_O = 0$ to 3A		12	60	V
V_d	Dropout Voltage	$I_O = 3$ A		1.3	1.5	V
I_q	Quiescent Current	$V_I \leq 30V$		5	10	mA
I_{sc}	Short Circuit Current	$V_I - V_O = 5V$	5.5	6.5		A
		$V_I - V_O = 25V$	0.5	0.7		A
	Thermal Regulation	$T_A = 25^\circ C$, 30ms pulse		0.008	0.04	%/W
SVR	Supply Voltage Rejection	$f = 120$ Hz, $C_O = 25 \mu F$, $I_O = 3A$ $V_I = 14 \pm 3V$	54	70		dB
eN	RMS Output Noise Voltage (% of V_O)	$T_A = 25^\circ C$ $f = 10$ Hz to 10KHz		0.003		%
S	Temperature Stability			0.5		%
S	Long Term Stability	$T_A = 125^\circ C$ 1000Hrs		0.5		%

NOTE 1: See short-circuit current curve for available output current at fixed dropout.

ELECTRICAL CHARACTERISTICS OF LD1085CDT120 ($V_I=15V$, $C_I = C_O = 10\mu F$, $T_A = -40$ to $125^\circ C$, unless otherwise specified.)

Symbol	Parameter	Test Conditions	Min.	Typ.	Max.	Unit
V_O	Output Voltage	$I_O = 0$ mA $T_J = 25^\circ C$	11.76	12	12.24	V
		$I_O = 0$ to 3A $V_I = 13.8$ to 30V (note 1)	11.64	12	12.36	V
ΔV_O	Line Regulation	$I_O = 0$ mA $V_I = 13.8$ to 25V $T_J = 25^\circ C$		1	25	mV
		$I_O = 0$ mA $V_I = 13.8$ to 25V		2	25	mV
ΔV_O	Load Regulation	$I_O = 0$ to 3A $T_J = 25^\circ C$		12	36	mV
		$I_O = 0$ to 3A		24	72	V
V_d	Dropout Voltage	$I_O = 3$ A		1.3	1.5	V
I_q	Quiescent Current	$V_I \leq 30V$		5	10	mA
I_{sc}	Short Circuit Current	$V_I - V_O = 5V$	3.2	4.5		A
		$V_I - V_O = 25V$	0.2	0.5		A
	Thermal Regulation	$T_A = 25^\circ C$, 30ms pulse		0.008	0.04	%/W
SVR	Supply Voltage Rejection	$f = 120$ Hz, $C_O = 25 \mu F$, $I_O = 3A$ $V_I = 17 \pm 3V$	54	66		dB
eN	RMS Output Noise Voltage (% of V_O)	$T_A = 25^\circ C$ $f = 10$ Hz to 10KHz		0.003		%
S	Temperature Stability			0.5		%
S	Long Term Stability	$T_A = 125^\circ C$ 1000Hrs		0.5		%

NOTE 1: See short-circuit current curve for available output current at fixed dropout.

ELECTRICAL CHARACTERISTICS OF LD1085CDT ($V_I=4.25V$, $C_I = C_O = 10\mu F$, $T_A = -40$ to $125^\circ C$, unless otherwise specified.)

Symbol	Parameter	Test Conditions	Min.	Typ.	Max.	Unit
V_O	Output Voltage	$I_O = 10mA$ $T_J = 25^\circ C$	1.225	1.25	1.275	V
		$I_O = 10mA$ to $5A$ $V_I = 2.85$ to $30V$ (note 1)	1.213	1.25	1.288	V
ΔV_O	Line Regulation	$I_O = 10mA$ $V_I = 2.85$ to $16.5V$ $T_J = 25^\circ C$		0.015	0.2	%
		$I_O = 10mA$ $V_I = 2.85$ to $16.5V$		0.035	0.2	%
ΔV_O	Load Regulation	$I_O = 10mA$ to $5A$ $T_J = 25^\circ C$		0.1	0.3	%
		$I_O = 0$ to $5A$		0.2	0.4	%
V_d	Dropout Voltage	$I_O = 5A$		1.3	1.5	V
$I_{O(min)}$	Minimum Load Current	$V_I = 30V$		3	10	mA
I_{sc}	Short Circuit Current	$V_I - V_O = 5V$	3.2	4.5		A
		$V_I - V_O = 25V$	0.2	0.5		A
	Thermal Regulation	$T_A = 25^\circ C$, 30ms pulse		0.003	0.015	%/W
SVR	Supply Voltage Rejection	$f = 120$ Hz, $C_O = 25 \mu F$, $C_{ADJ} = 25 \mu F$, $I_O = 5A$ $V_I = 6.25 \pm 3V$	60	75		dB
I_{ADJ}	Adjust Pin Current	$V_I = 4.25V$ $I_O = 10$ mA		55	120	μA
ΔI_{ADJ}	Adjust Pin Current Change	$I_O = 10mA$ to $5A$ $V_I = 2.75$ to $16.5V$ (note 1)		0.2	5	μA
eN	RMS Output Noise Voltage (% of V_O)	$T_A = 25^\circ C$ $f = 10Hz$ to $10KHz$		0.003		%
S	Temperature Stability			0.5		%
S	Long Term Stability	$T_A = 125^\circ C$ 1000Hrs		0.5		%

NOTE 1: See short-circuit current curve for available output current at fixed dropout.

TYPICAL CHARACTERISTICS (unless otherwise specified $T_j = 25^\circ\text{C}$, $C_i=C_o=10\mu\text{F}$)

Figure 1 : Output Voltage vs Temperature

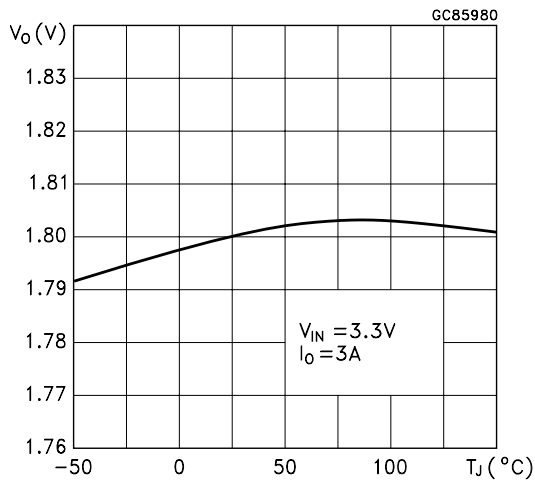

Figure 2 : Output Voltage vs Temperature

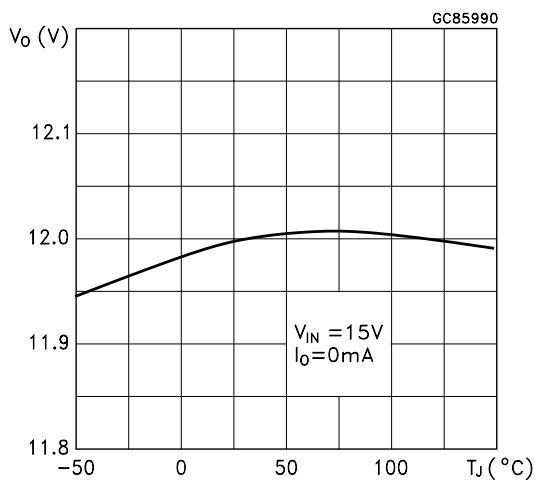

Figure 3 : Output Voltage vs Temperature

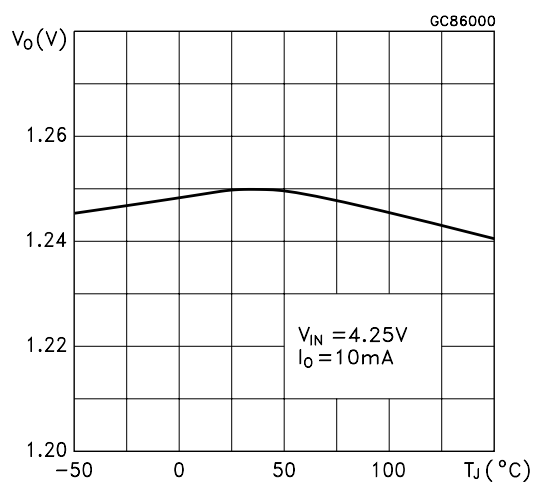

Figure 4 : Short Circuit Current vs Dropout Voltage

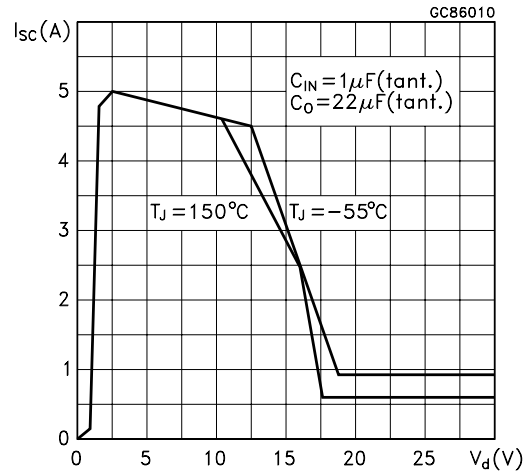

Figure 5 : Line Regulation vs Temperature

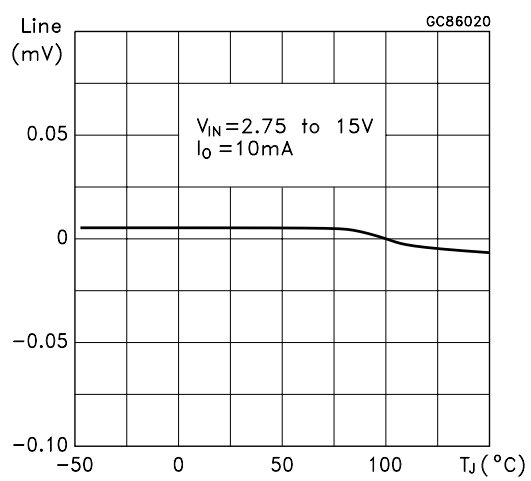

Figure 6 : Load Regulation vs Temperature

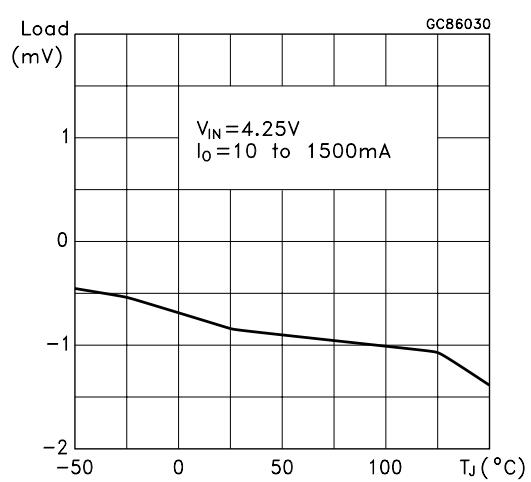

Figure 7 : Dropout Voltage vs Temperature

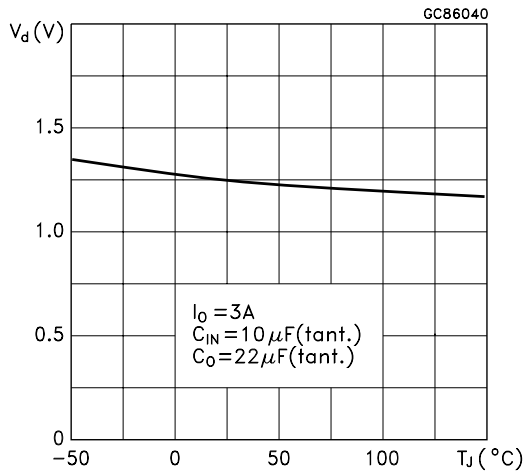

Figure 10 : Quiescent Current vs Temperature

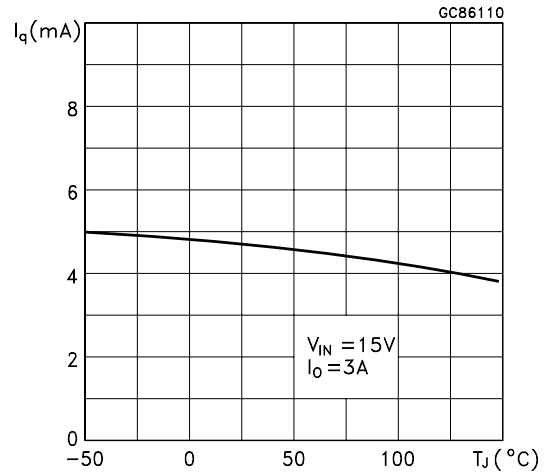

Figure 8 : Dropout Voltage vs Output Current

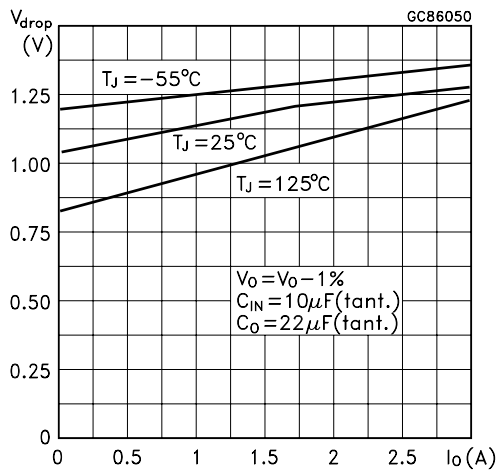

Figure 11 : Dropout Voltage vs Output Current

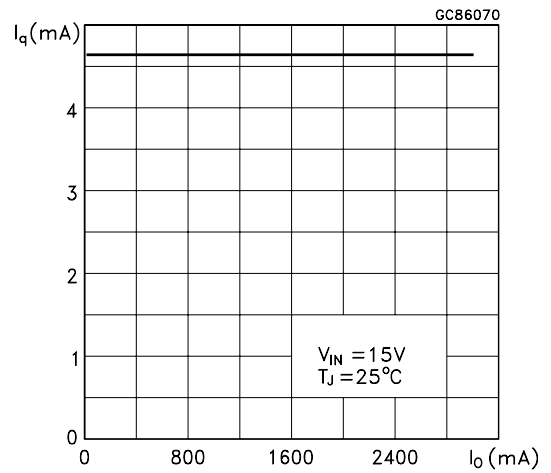

Figure 9 : Adjust Pin Current vs Temperature

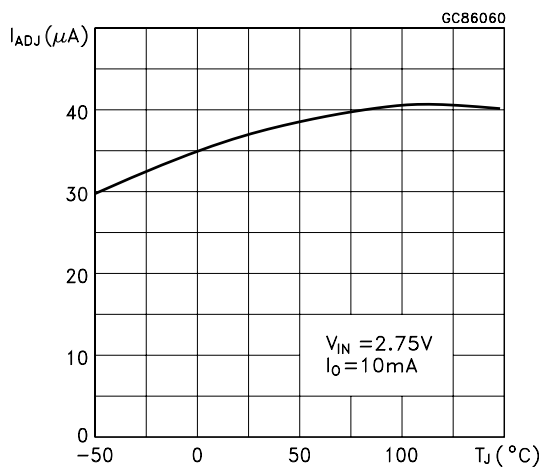

Figure 12 : Supply Voltage Rejection vs Output Current

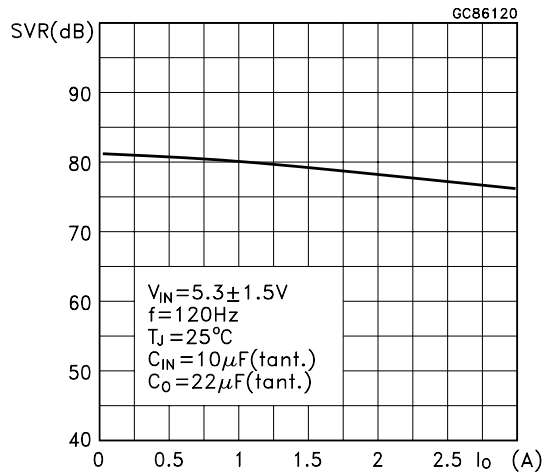

Figure 13 : Supply Voltage Rejection vs Frequency

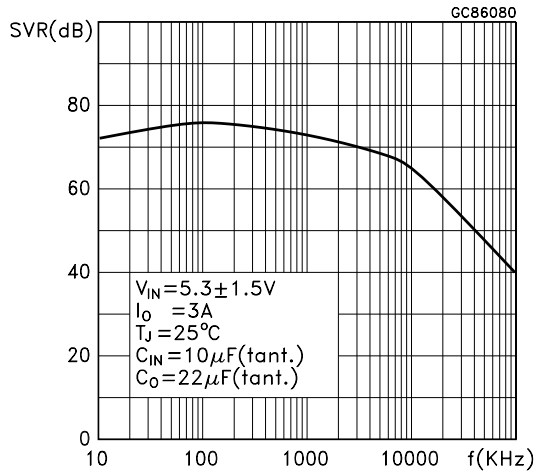

Figure 14 : Supply Voltage Rejection vs Temperature

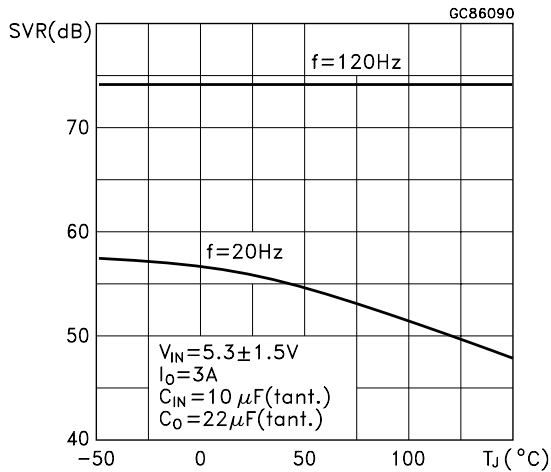

Figure 15 : Minimum Load Current vs Temperature

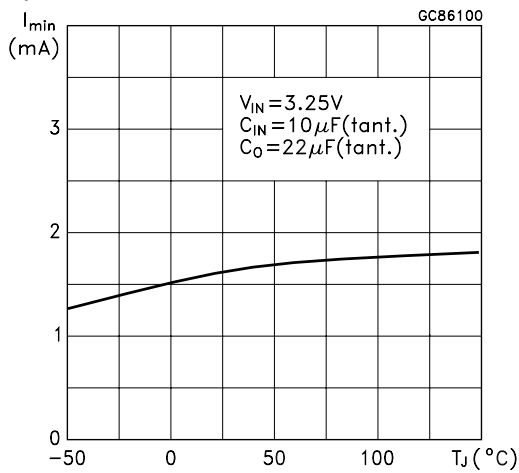

Figure 16 : Stability

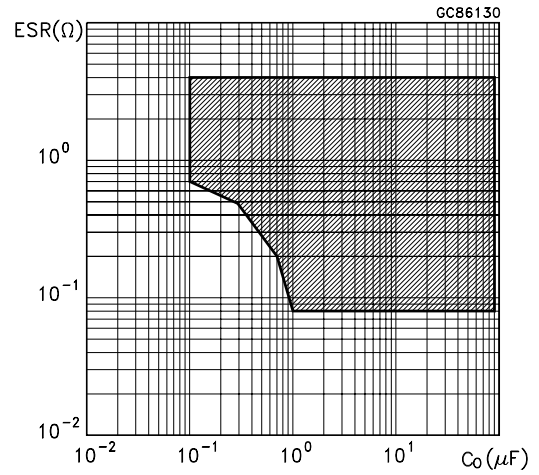

Figure 17 : Stability

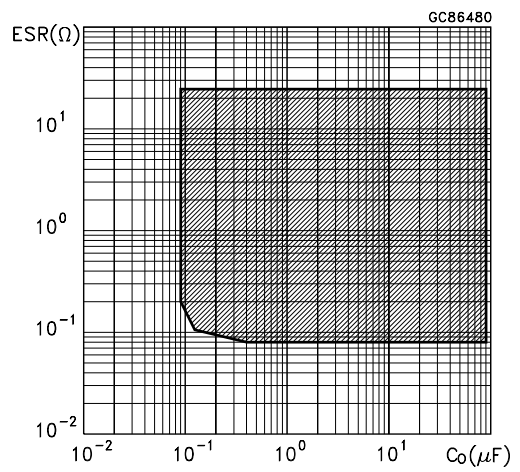

Figure 18 : Line Transient

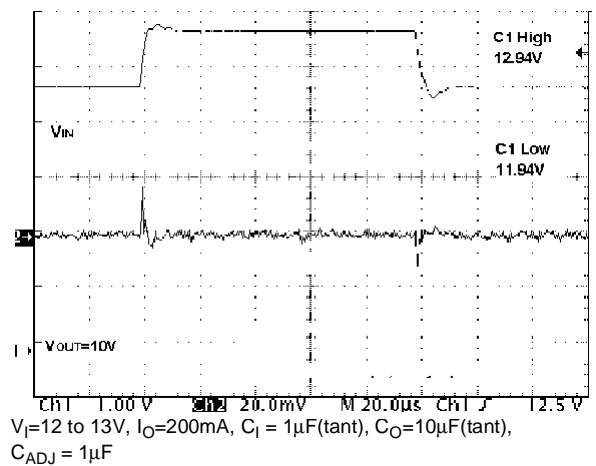
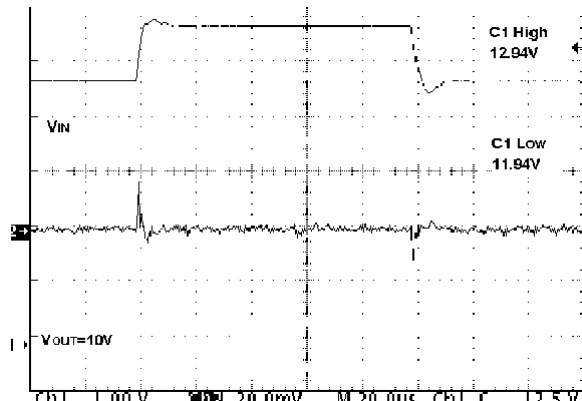
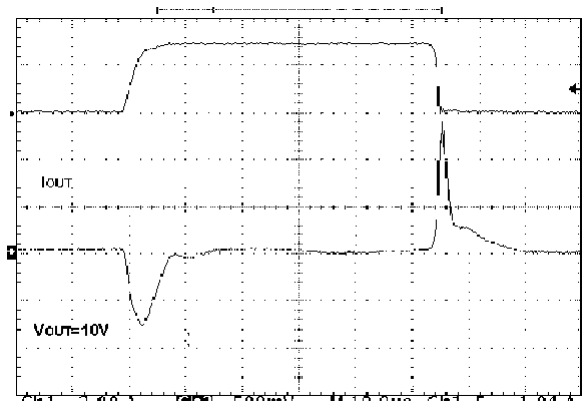

Figure 19 : Line Transient



$V_I=12$ to 13 V, $I_O=200$ mA, $C_I = 1\mu$ F(tant), $C_O=10\mu$ F(tant), $C_{ADJ}=1\mu$ F

Figure 21 : Load Transient



$V_I=12$ V, $I_O=0.12$ to 3 A, $C_I = 1\mu$ F(tant), $C_O=10\mu$ F(tant), $C_{ADJ}=1\mu$ F

Figure 20 : Load Transient

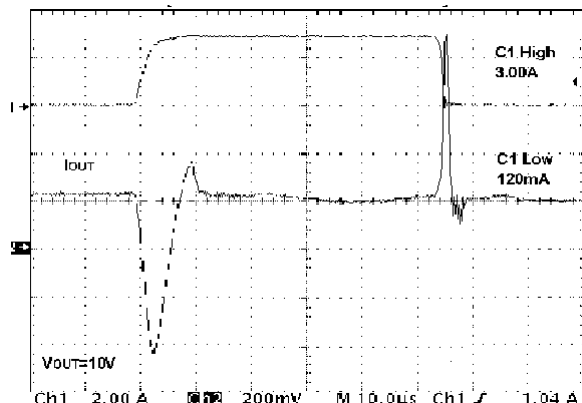

$V_I=12$ V, $I_O=0.12$ to 3 A, $C_I = 1\mu$ F(tant), $C_O=10\mu$ F(tant), $C_{ADJ}=1\mu$ F

DPAK MECHANICAL DATA

DIM.	mm.			inch		
	MIN.	TYP	MAX.	MIN.	TYP.	MAX.
A	2.2		2.4	0.086		0.094
A1	0.9		1.1	0.035		0.043
A2	0.03		0.23	0.001		0.009
B	0.64		0.9	0.025		0.035
B2	5.2		5.4	0.204		0.212
C	0.45		0.6	0.017		0.023
C2	0.48		0.6	0.019		0.023
D	6		6.2	0.236		0.244
E	6.4		6.6	0.252		0.260
G	4.4		4.6	0.173		0.181
H	9.35		10.1	0.368		0.397
L2		0.8			0.031	
L4	0.6		1	0.023		0.039

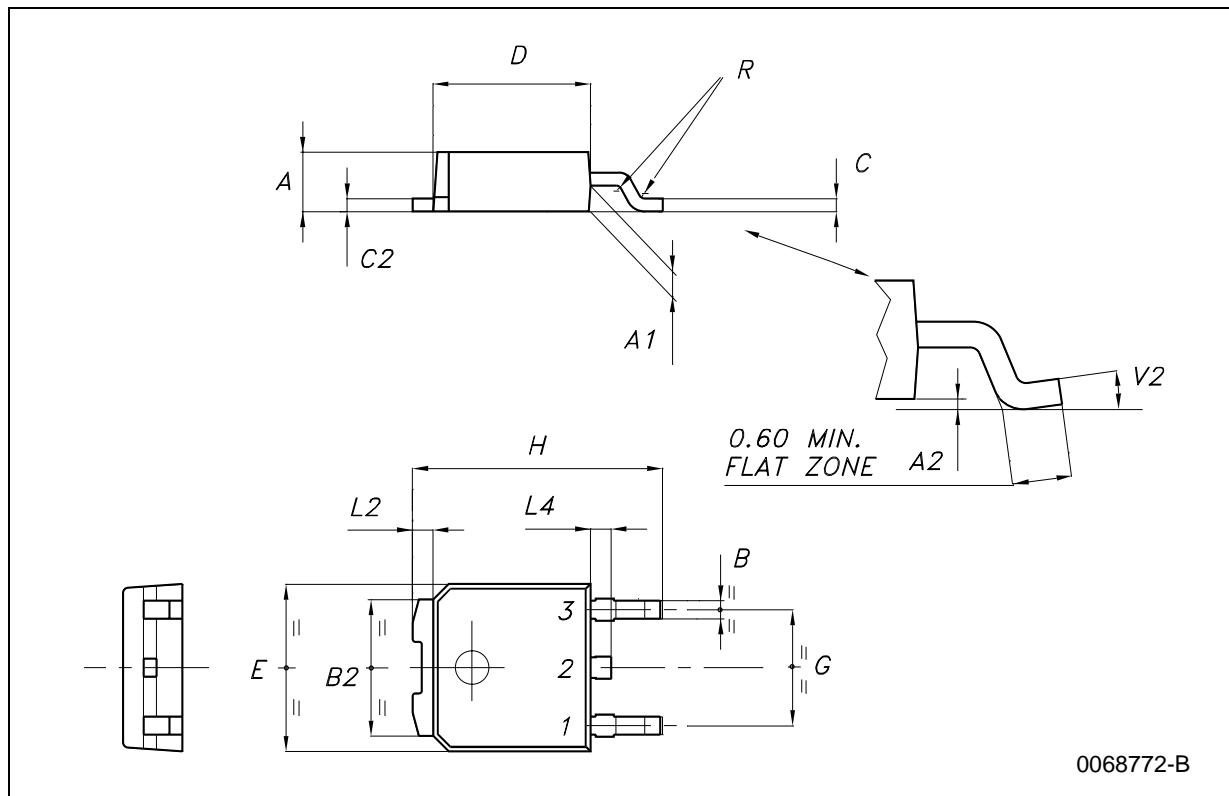

Information furnished is believed to be accurate and reliable. However, STMicroelectronics assumes no responsibility for the consequences of use of such information nor for any infringement of patents or other rights of third parties which may result from its use. No license is granted by implication or otherwise under any patent or patent rights of STMicroelectronics. Specifications mentioned in this publication are subject to change without notice. This publication supersedes and replaces all information previously supplied. STMicroelectronics products are not authorized for use as critical components in life support devices or systems without express written approval of STMicroelectronics.

© The ST logo is a registered trademark of STMicroelectronics

© 2002 STMicroelectronics - Printed in Italy - All Rights Reserved
STMicroelectronics GROUP OF COMPANIES

Australia - Brazil - Canada - China - Finland - France - Germany - Hong Kong - India - Israel - Italy - Japan - Malaysia - Malta - Morocco
Singapore - Spain - Sweden - Switzerland - United Kingdom - United States.

© <http://www.st.com>

