

COMPLEMENTARY SILICON PNP TRANSISTORS

- SGS-THOMSON PREFERRED SALESTYPES
- LOW COLLECTOR-EMITTER SATURATION VOLTAGE
- FAST SWITCHING SPEED

APPLICATIONS

- GENERAL PURPOSE SWITCHING
- GENERAL PURPOSE AMPLIFIER

DESCRIPTION

The MJD44H11 is a silicon multiepitaxial planar NPN transistors mounted in DPAK plastic package.

It is intended for various switching and general purpose applications.

The complementary PNP type is MJD45H11.

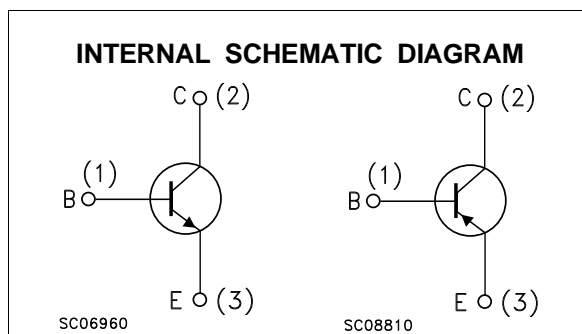
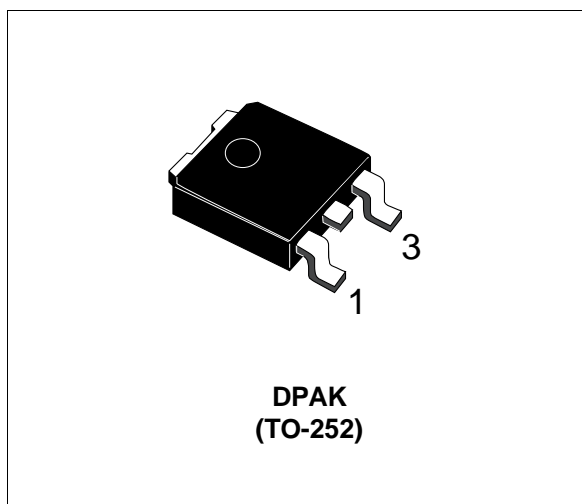

ABSOLUTE MAXIMUM RATINGS

Symbol	Parameter	Value		Unit
		NPN	MJD44H11	
		PNP	MJD45H11	
V_{CE0}	Collector-Emitter Voltage ($I_B = 0$)		80	V
V_{EBO}	Emitter-Base Voltage ($I_C = 0$)		5	V
I_C	Collector Current		8	A
I_{CM}	Collector Peak Current		16	A
P_{tot}	Total Dissipation at $T_c \leq 25^\circ\text{C}$		20	W
T_{stg}	Storage Temperature		-55 to 150	$^\circ\text{C}$
T_j	Max. Operating Junction Temperature		150	$^\circ\text{C}$

For PNP types the values are intended negative.

MJD44H11 / MJD45H11

THERMAL DATA

$R_{thj-case}$	Thermal Resistance Junction-case	Max	6.25	$^{\circ}C/W$
----------------	----------------------------------	-----	------	---------------

ELECTRICAL CHARACTERISTICS ($T_{case} = 25^{\circ}C$ unless otherwise specified)

Symbol	Parameter	Test Conditions	Min.	Typ.	Max.	Unit
$V_{CE(sus)}^*$	Collector-Emitter Sustaining Voltage	$I_C = 30\text{ mA}$	80			V
I_{CES}	Collector Cut-off Current	$V_{CB} = \text{rated } V_{CEO} \quad V_{BE} = 0$			10	μA
I_{EBO}	Emitter Cut-off Current	$V_{EB} = 5V$			50	μA
$V_{CE(sat)}^*$	Collector-Emitter Saturation Voltage	$I_C = 8\text{ A} \quad I_B = 0.4\text{ A}$			1	V
$V_{BE(sat)}^*$	Base-Emitter Saturation Voltage	$I_C = 8\text{ A} \quad I_B = 0.8\text{ A}$			1.5	V
h_{FE}^*	DC Current Gain	$I_C = 2\text{ A} \quad V_{CE} = 1\text{ V}$ $I_C = 4\text{ A} \quad V_{CE} = 1\text{ V}$	60 40			

* Pulsed: Pulse duration = 300 μs , duty cycle $\leq 2\%$

* For PNP types the values are intended negative.

Safe Operating Area

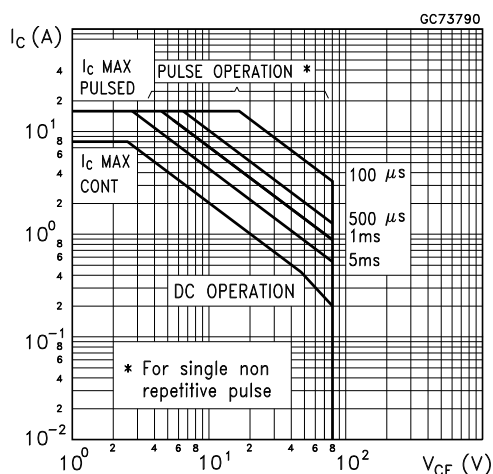

Derating Curves

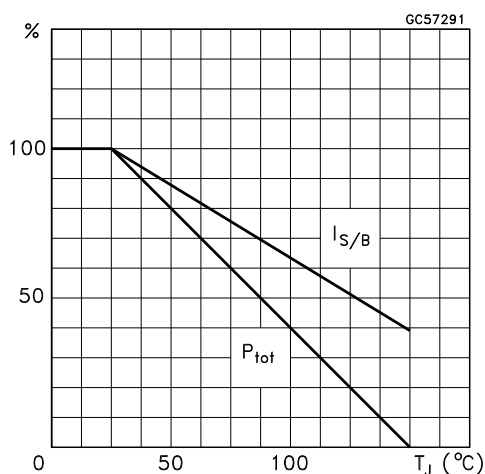

DC Current Gain (NPN type)

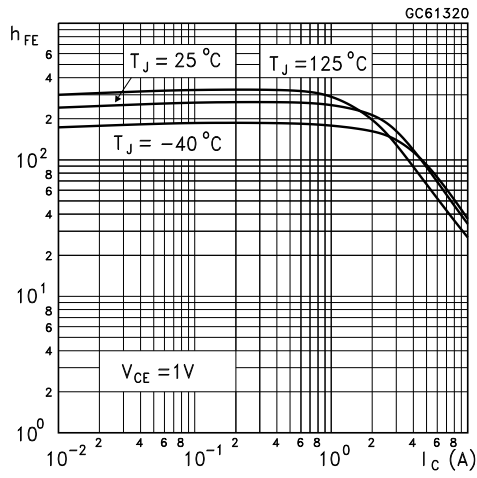

DC Current Gain (PNP type)

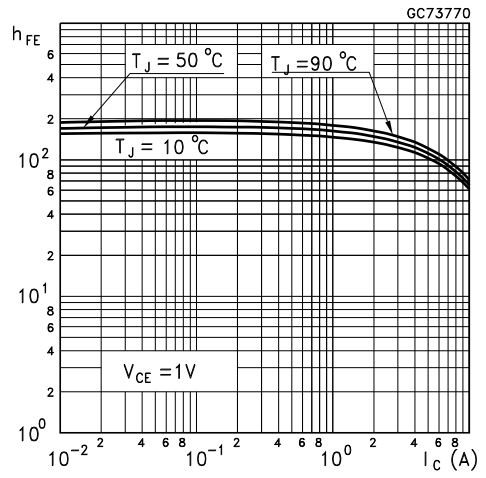

Collector-Emitter Saturation Voltage (NPN type)

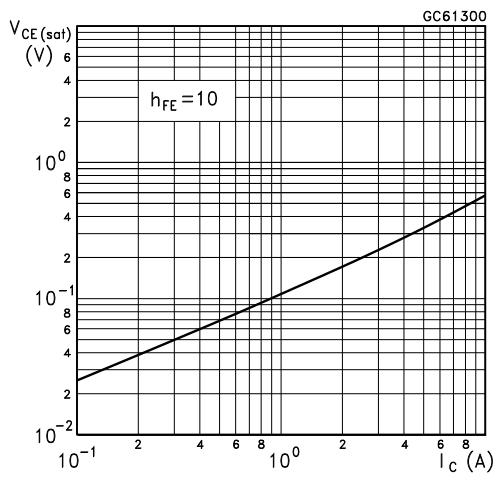

Collector-Emitter Saturation Voltage (PNP type)

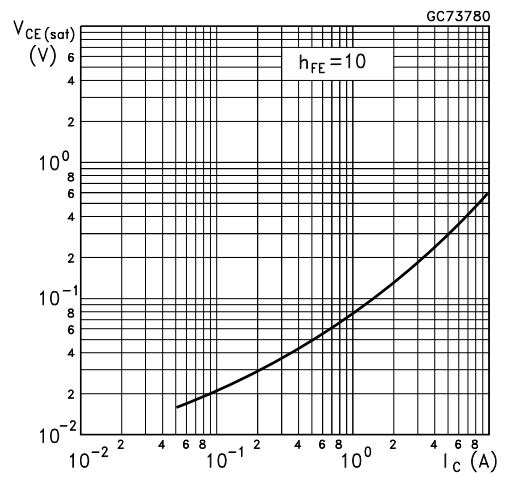

TO-252 (DPAK) MECHANICAL DATA

DIM.	mm			inch		
	MIN.	TYP.	MAX.	MIN.	TYP.	MAX.
A	2.2		2.4	0.086		0.094
A1	0.9		1.1	0.035		0.043
A2	0.03		0.23	0.001		0.009
B	0.64		0.9	0.025		0.035
B2	5.2		5.4	0.204		0.212
C	0.45		0.6	0.017		0.023
C2	0.48		0.6	0.019		0.023
D	6		6.2	0.236		0.244
E	6.4		6.6	0.252		0.260
G	4.4		4.6	0.173		0.181
H	9.35		10.1	0.368		0.397
L2		0.8			0.031	
L4	0.6		1	0.023		0.039

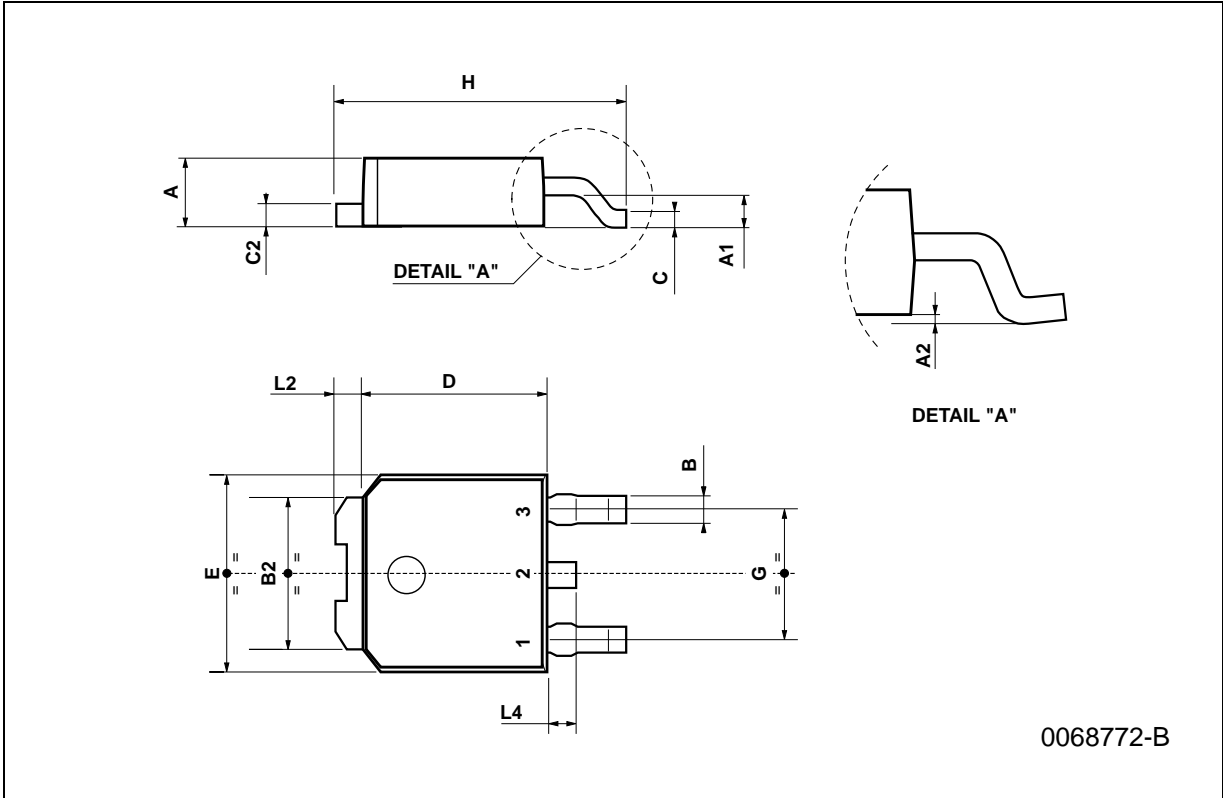

Information furnished is believed to be accurate and reliable. However, SGS-THOMSON Microelectronics assumes no responsibility for the consequences of use of such information nor for any infringement of patents or other rights of third parties which may result from its use. No license is granted by implication or otherwise under any patent or patent rights of SGS-THOMSON Microelectronics. Specifications mentioned in this publication are subject to change without notice. This publication supersedes and replaces all information previously supplied. SGS-THOMSON Microelectronics products are not authorized for use as critical components in life support devices or systems without express written approval of SGS-THOMSON Microelectronics.

© 1997 SGS-THOMSON Microelectronics - Printed in Italy - All Rights Reserved

SGS-THOMSON Microelectronics GROUP OF COMPANIES

Australia - Brazil - Canada - China - France - Germany - Italy - Japan - Korea - Malaysia - Malta - Morocco - The Netherlands -
Singapore - Spain - Sweden - Switzerland - Taiwan - Thailand - United Kingdom - U.S.A

...