



STB50NE10L

N-CHANNEL 100V - 0.020 Ω - 50A D²PAK

STripFET™ POWER MOSFET

TYPE	V _{DSS}	R _{DS(on)}	I _D
STB50NE10L	100 V	<0.025 Ω	50 A

- TYPICAL R_{DS(on)} = 0.020 Ω
- EXCEPTIONAL dv/dt CAPABILITY
- 100% AVALANCHE TESTED
- LOW GATE CHARGE AT 100 °C
- APPLICATION ORIENTED CHARACTERIZATION
- FOR THROUGH-HOLE VERSION CONTACT SALES OFFICE

DESCRIPTION

This Power MOSFET is the latest development of STMicroelectronics unique "Single Feature Size™" strip-based process. The resulting transistor shows extremely high packing density for low on-resistance, rugged avalanche characteristics and less critical alignment steps therefore a remarkable manufacturing reproducibility.

APPLICATIONS

- HIGH CURRENT, HIGH SWITCHING SPEED
- SOLENOID AND RELAY DRIVERS
- MOTOR CONTROL, AUDIO AMPLIFIERS
- DC-DC & DC-AC CONVERTERS
- AUTOMOTIVE ENVIRONMENT (INJECTION, ABS, AIR-BAG, LAMPDRIVERS, Etc.)

ABSOLUTE MAXIMUM RATINGS

Symbol	Parameter	Value	Unit
V _{DS}	Drain-source Voltage (V _{GS} = 0)	100	V
V _{DGR}	Drain-gate Voltage (R _{GS} = 20 k Ω)	100	V
V _{GS}	Gate- source Voltage	± 20	V
I _D	Drain Current (continuous) at T _C = 25°C	50	A
I _D	Drain Current (continuous) at T _C = 100°C	35	A
I _{DM} (●)	Drain Current (pulsed)	200	A
P _{tot}	Total Dissipation at T _C = 25°C	150	W
	Derating Factor	1.0	W/°C
dv/dt (1)	Peak Diode Recovery voltage slope	6	V/ns
T _{stg}	Storage Temperature	-65 to 175	°C
T _j	Max. Operating Junction Temperature	175	°C

(●) Pulse width limited by safe operating area

(1) I_{SD} \leq 50A, di/dt \leq 275A/ μ s, V_{DD} \leq V(BR)_{DSS}, T_j \leq T_{JMAX}

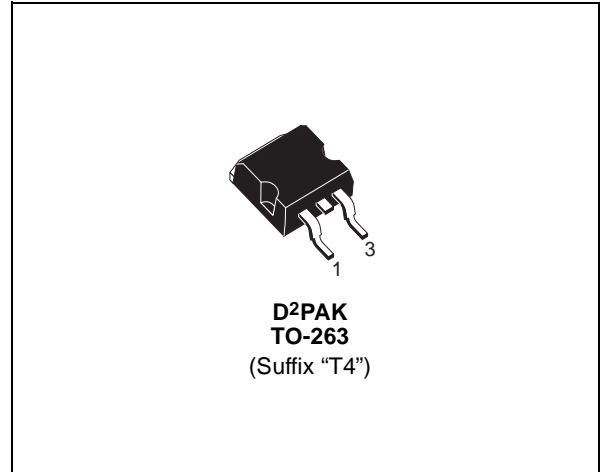

INTERNAL SCHEMATIC DIAGRAM

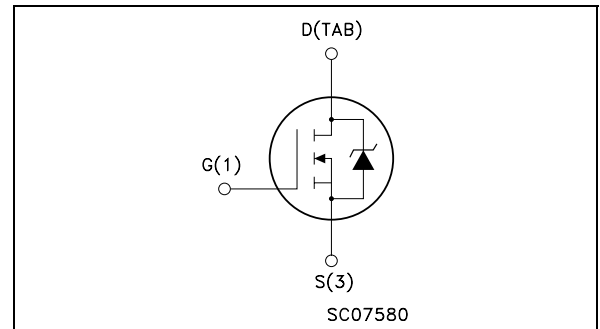

STB50NE10L

THERMAL DATA

Rthj-case	Thermal Resistance Junction-case	Max	1	°C/W
Rthj-amb	Thermal Resistance Junction-ambient	Max	62.5	°C/W
Rthc-sink	Thermal Resistance Case-sink	Typ	0.5	°C/W
T _l	Maximum Lead Temperature For Soldering Purpose		300	°C

AVALANCHE CHARACTERISTICS

Symbol	Parameter	Max Value	Unit
I _{AR}	Avalanche Current, Repetitive or Not-Repetitive (pulse width limited by T _j max)	50	A
EAS	Single Pulse Avalanche Energy (starting T _j = 25 °C, I _D = I _{AR} , V _{DD} = 50 V)	400	mJ

ELECTRICAL CHARACTERISTICS (T_{case} = 25 °C unless otherwise specified)

OFF

Symbol	Parameter	Test Conditions	Min.	Typ.	Max.	Unit
V _{(BR)DSS}	Drain-source Breakdown Voltage	I _D = 250 μA, V _{GS} = 0	100			V
I _{DSS}	Zero Gate Voltage Drain Current (V _{GS} = 0)	V _{DS} = Max Rating V _{DS} = Max Rating T _C = 125°C			1 10	μA μA
I _{GSS}	Gate-body Leakage Current (V _{DS} = 0)	V _{GS} = ± 20V			±100	nA

ON (*)

Symbol	Parameter	Test Conditions	Min.	Typ.	Max.	Unit
V _{GS(th)}	Gate Threshold Voltage	V _{DS} = V _{GS} I _D = 250 μA	1	1.7	2.5	V
R _{DS(on)}	Static Drain-source On Resistance	V _{GS} = 10 V I _D = 25 A V _{GS} = 5 V I _D = 25 A		0.020 0.024	0.025 0.030	Ω Ω

DYNAMIC

Symbol	Parameter	Test Conditions	Min.	Typ.	Max.	Unit
g _{fs} (*)	Forward Transconductance	V _{DS} > I _{D(on)} × R _{DS(on)} max I _D = 25 A		45		S
C _{iss}	Input Capacitance	V _{DS} = 25V f = 1 MHz V _{GS} = 0		5000		pF
C _{oss}	Output Capacitance			500		pF
C _{rss}	Reverse Transfer Capacitance			180		pF

ELECTRICAL CHARACTERISTICS (continued)

SWITCHING ON

Symbol	Parameter	Test Conditions	Min.	Typ.	Max.	Unit
$t_{d(on)}$ t_r	Turn-on Time Rise Time	$V_{DD} = 50\text{ V}$ $I_D = 25\text{ A}$ $R_G = 4.7\ \Omega$ $V_{GS} = 5\text{ V}$ (Resistive Load, Figure 3)		30 105		ns ns
Q_g Q_{gs} Q_{gd}	Total Gate Charge Gate-Source Charge Gate-Drain Charge	$V_{DD} = 80\text{ V}$ $I_D = 50\text{ A}$ $V_{GS} = 5\text{ V}$		82 17 49	105	nC nC nC

SWITCHING OFF

Symbol	Parameter	Test Conditions	Min.	Typ.	Max.	Unit
$t_{d(off)}$ t_f	Turn-off Delay Time Fall Time	$V_{DD} = 50\text{ V}$ $I_D = 25\text{ A}$ $R_G = 4.7\ \Omega$, $V_{GS} = 5\text{ V}$ (Resistive Load, Figure 3)		135 45		ns ns
$t_r(V_{off})$ t_f t_c	Off-Voltage Rise Time Fall Time Cross-over Time	$V_{clamp} = 80\text{ V}$ $I_D = 50\text{ A}$ $R_G = 4.7\ \Omega$ $V_{GS} = 5\text{ V}$ (Inductive Load, Figure 5)		45 45 85		ns ns ns

SOURCE DRAIN DIODE

Symbol	Parameter	Test Conditions	Min.	Typ.	Max.	Unit
I_{SD} $I_{SDM} (\bullet)$	Source-drain Current Source-drain Current (pulsed)				50 200	A A
$V_{SD} (*)$	Forward On Voltage	$I_{SD} = 50\text{ A}$ $V_{GS} = 0$			1.5	V
t_{rr} Q_{rr} I_{RRM}	Reverse Recovery Time Reverse Recovery Charge Reverse Recovery Current	$I_{SD} = 30\text{ A}$ $di/dt = 100\text{ A}/\mu\text{s}$ $V_{DD} = 50\text{ V}$ $T_j = 150^\circ\text{C}$ (see test circuit, Figure 5)		165 870 10.5		ns nC A

(*)Pulsed: Pulse duration = 300 μs , duty cycle 1.5 %.
 (•)Pulse width limited by safe operating area.

Safe Operating Area

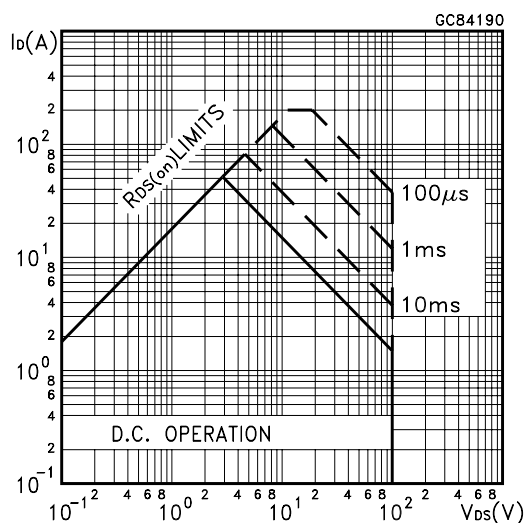

Thermal Impedance

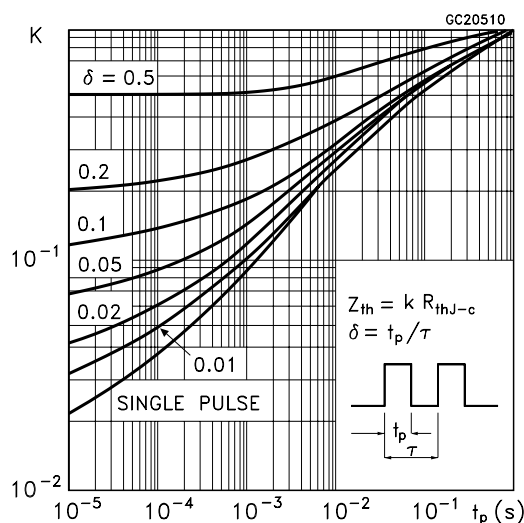

STB50NE10L

Output Characteristics

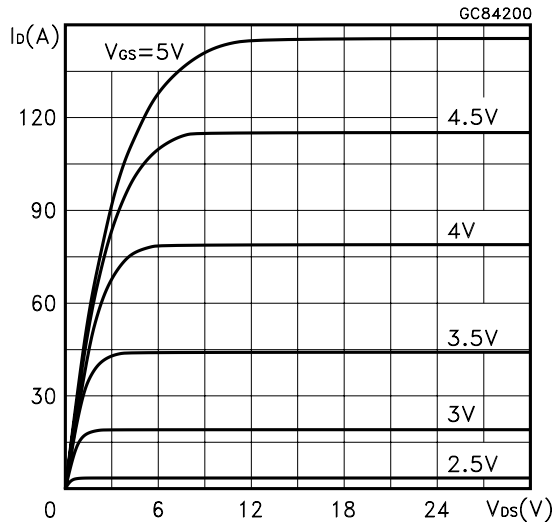

Transfer Characteristics

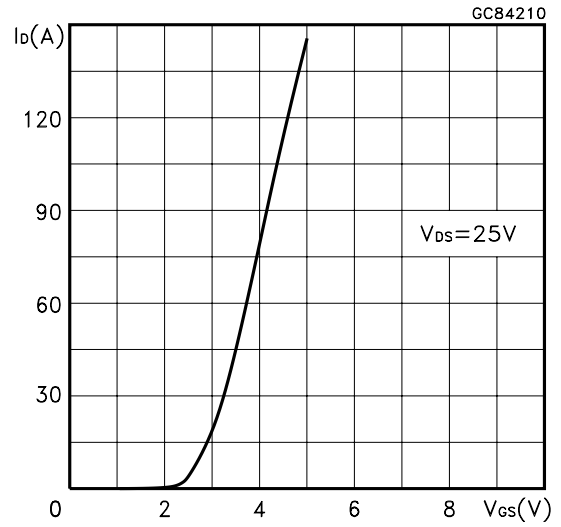

Transconductance

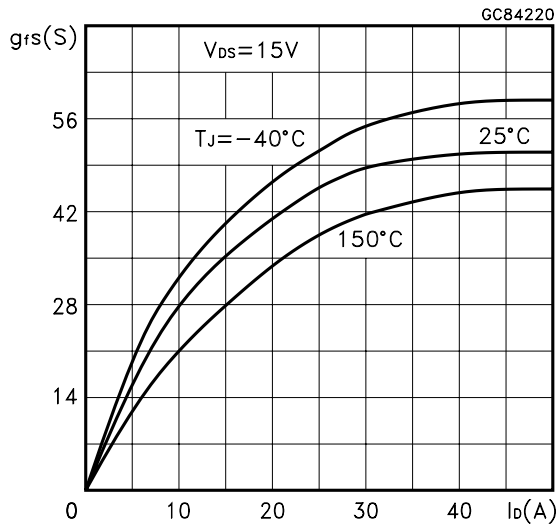

Static Drain-source On Resistance

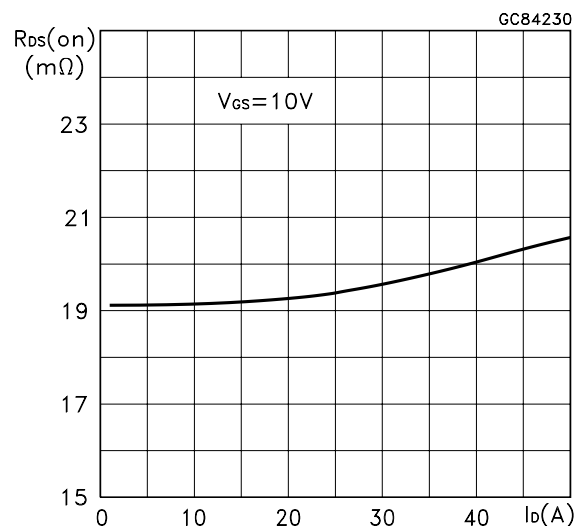

Gate Charge vs Gate-source Voltage

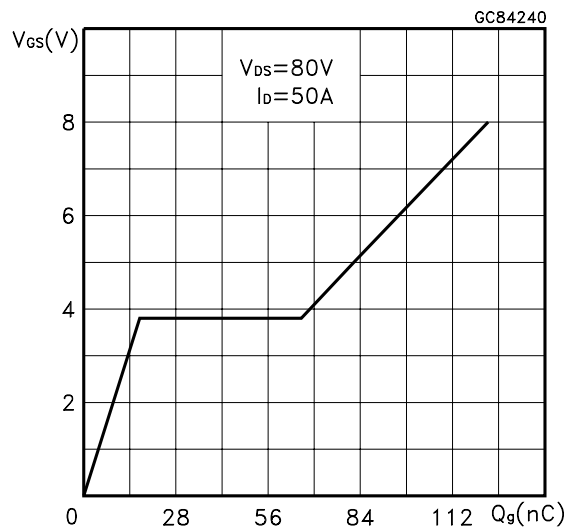

Capacitance Variations

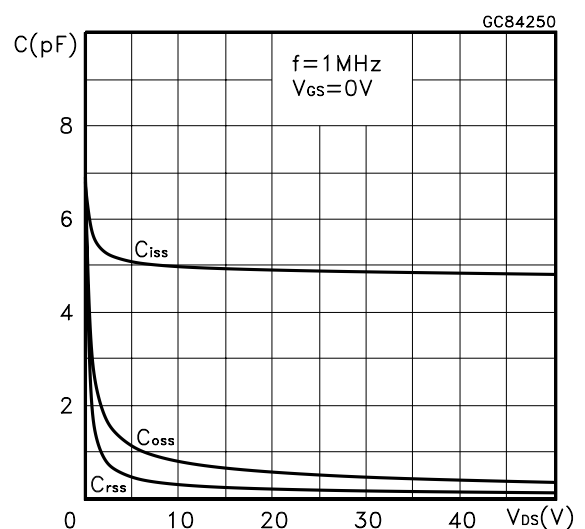

Normalized Gate Threshold Voltage vs Temperature

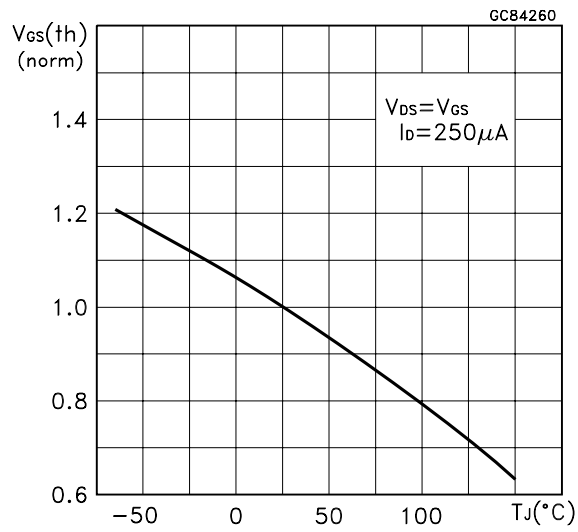

Normalized on Resistance vs Temperature

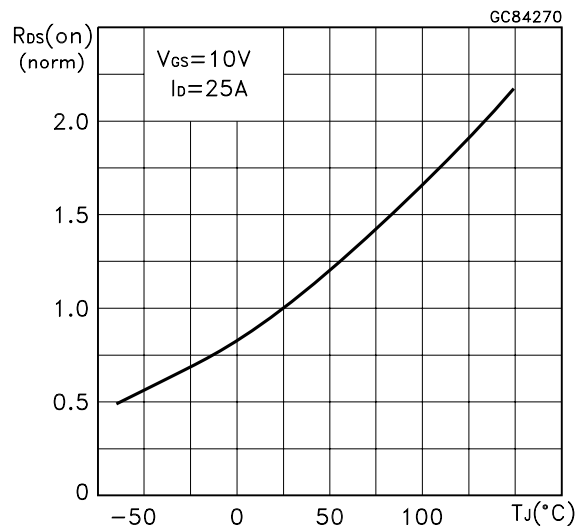

Source-drain Diode Forward Characteristics

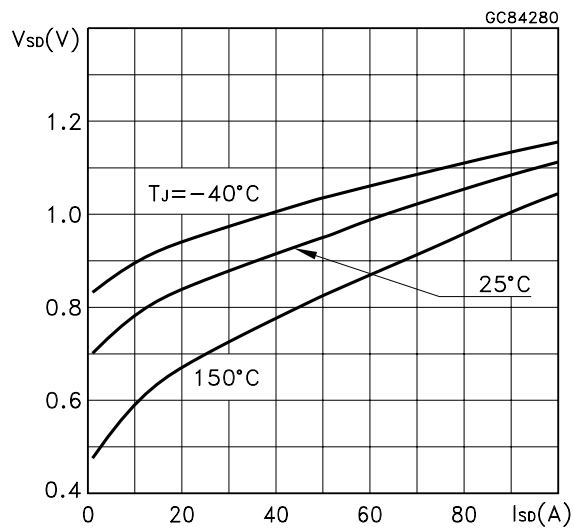

Fig. 1: Unclamped Inductive Load Test Circuit



Fig. 2: Unclamped Inductive Waveform



Fig. 3: Switching Times Test Circuits For Resistive Load



Fig. 4: Gate Charge test Circuit

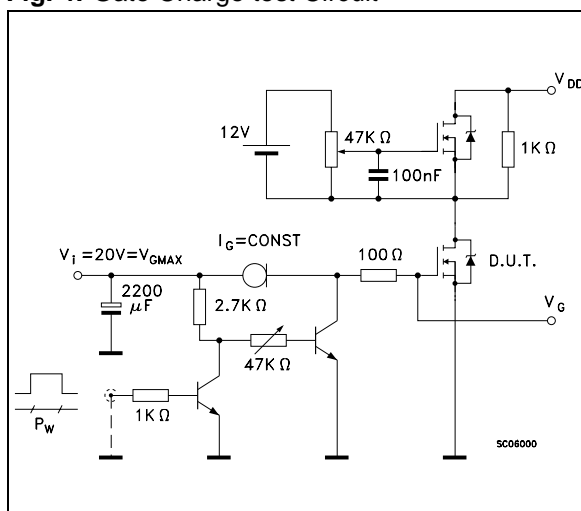
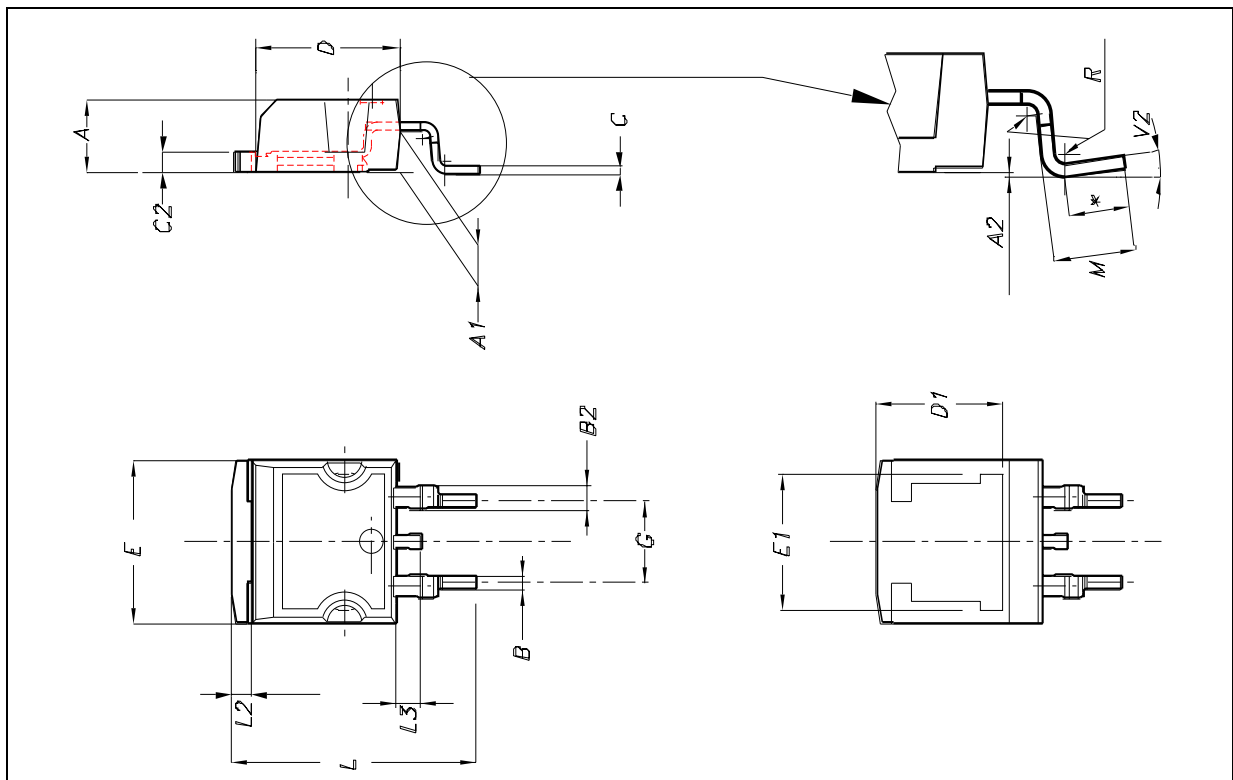

Fig. 5: Test Circuit For Inductive Load Switching And Diode Recovery Times



D²PAK MECHANICAL DATA

DIM.	mm.			inch.		
	MIN.	TYP.	MAX.	MIN.	TYP.	TYP.
A	4.4		4.6	0.173		0.181
A1	2.49		2.69	0.098		0.106
A2	0.03		0.23	0.001		0.009
B	0.7		0.93	0.028		0.037
B2	1.14		1.7	0.045		0.067
C	0.45		0.6	0.018		0.024
C2	1.21		1.36	0.048		0.054
D	8.95		9.35	0.352		0.368
D1		8			0.315	
E	10		10.4	0.394		0.409
E1	8.5				0.334	
G	4.88		5.28	0.192		0.208
L	15		15.85	0.591		0.624
L2	1.27		1.4	0.050		0.055
L3	1.4		1.75	0.055		0.069
M	2.4		3.2	0.094		0.126
R		0.4			0.016	
V2	0°		8°	0°		8°



D2PAK FOOTPRINT

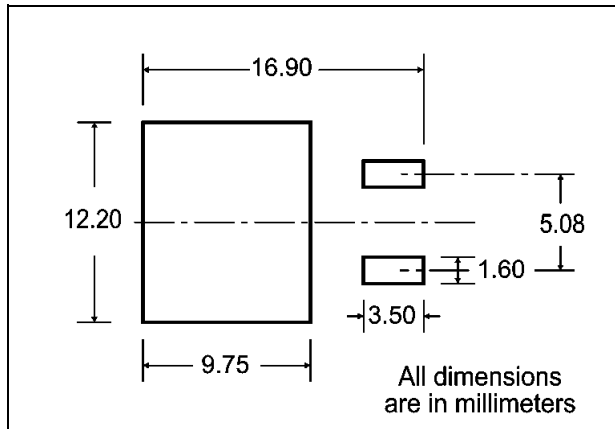

TUBE SHIPMENT (no suffix)*

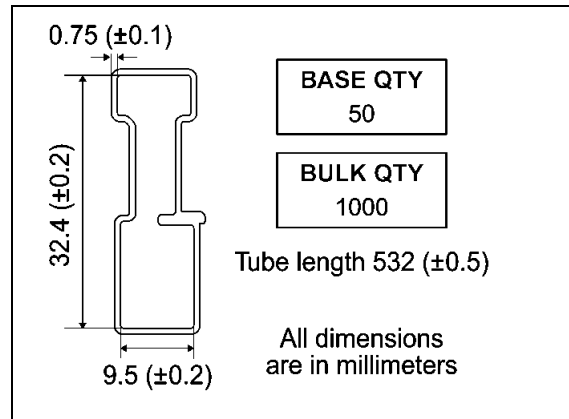

TAPE AND REEL SHIPMENT (suffix "T4")*

Diagram showing the tape and reel shipment details. The top view shows a circular reel with a diameter of A. The tape slot in the core has a width of 2.5 mm min. and a full radius. The distance from the center of the reel to the start of the tape slot is B. The distance from the center of the reel to the center of the tape slot is D. The distance from the center of the reel to the center of the tape slot is also labeled as 40 mm min. Access hole at slot location. The side view shows the tape thickness T, the distance from the center of the reel to the center of the tape slot C, the distance from the center of the reel to the center of the tape slot N, and the distance from the center of the reel to the center of the tape slot G measured at the hub.

REEL MECHANICAL DATA

DIM.	mm		inch	
	MIN.	MAX.	MIN.	MAX.
A		330		12.992
B	1.5		0.059	
C	12.8	13.2	0.504	0.520
D	20.2		0.795	
G	24.4	26.4	0.960	1.039
N	100		3.937	
T		30.4		1.197

BASE QTY	BULK QTY
1000	1000

TAPE MECHANICAL DATA

DIM.	mm		inch	
	MIN.	MAX.	MIN.	MAX.
A0	10.5	10.7	0.413	0.421
B0	15.7	15.9	0.618	0.626
D	1.5	1.6	0.059	0.063
D1	1.59	1.61	0.062	0.063
E	1.65	1.85	0.065	0.073
F	11.4	11.6	0.449	0.456
K0	4.8	5.0	0.189	0.197
P0	3.9	4.1	0.153	0.161
P1	11.9	12.1	0.468	0.476
P2	1.9	2.1	0.075	0.082
R	50		1.574	
T	0.25	0.35	0.0098	0.0137
W	23.7	24.3	0.933	0.956

Diagram showing the tape mechanical data. The top view shows the tape with dimensions K0, D, P2, P0, E, F, W, B0, D1, A0, P1, and Center line of cavity. The distance from the center of the cavity to the center of the tape slot is P1. The distance from the center of the cavity to the center of the tape slot is also labeled as 10 pitches cumulative tolerance on tape +/- 0.2 mm. The side view shows the tape thickness T, the distance from the center of the cavity to the center of the tape slot K0, and the distance from the center of the cavity to the center of the tape slot D. The distance from the center of the cavity to the center of the tape slot is also labeled as P2. The distance from the center of the cavity to the center of the tape slot is also labeled as P0. The distance from the center of the cavity to the center of the tape slot is also labeled as E. The distance from the center of the cavity to the center of the tape slot is also labeled as F. The distance from the center of the cavity to the center of the tape slot is also labeled as W. The distance from the center of the cavity to the center of the tape slot is also labeled as B0. The distance from the center of the cavity to the center of the tape slot is also labeled as D1. The distance from the center of the cavity to the center of the tape slot is also labeled as A0. The distance from the center of the cavity to the center of the tape slot is also labeled as P1. The distance from the center of the cavity to the center of the tape slot is also labeled as Center line of cavity. The bottom view shows the tape with dimensions TRL and FEED DIRECTION. The distance from the center of the cavity to the center of the tape slot is also labeled as R min. The distance from the center of the cavity to the center of the tape slot is also labeled as Bending radius.

* on sales type

Information furnished is believed to be accurate and reliable. However, STMicroelectronics assumes no responsibility for the consequences of use of such information nor for any infringement of patents or other rights of third parties which may result from its use. No license is granted by implication or otherwise under any patent or patent rights of STMicroelectronics. Specifications mentioned in this publication are subject to change without notice. This publication supersedes and replaces all information previously supplied. STMicroelectronics products are not authorized for use as critical components in life support devices or systems without express written approval of STMicroelectronics.

The ST logo is registered trademark of STMicroelectronics
© 2001 STMicroelectronics - All Rights Reserved

All other names are the property of their respective owners.

STMicroelectronics GROUP OF COMPANIES

Australia - Brazil - Canada - China - Finland - France - Germany - Hong Kong - India - Israel - Italy - Japan - Malaysia - Malta - Morocco -
Singapore - Spain - Sweden - Switzerland - United Kingdom - United States.

<http://www.st.com>