



# STB85NF55L STP85NF55L

N-CHANNEL 55V - 0.0060 Ω - 80A D<sup>2</sup>PAK/TO-220  
STripFET™ II POWER MOSFET

TYPE	V <sub>DSS</sub>	R <sub>DS(on)</sub>	I <sub>D</sub>
STP85NF55L	55 V	<0.008 Ω	80 A
STB85NF55L	55 V	<0.008 Ω	80 A

- TYPICAL R<sub>DS(on)</sub> = 0.0060 Ω
- LOW THRESHOLD DRIVE
- LOGIC LEVEL DEVICE

## DESCRIPTION

This Power MOSFET is the latest development of STMicroelectronics unique "Single Feature Size™" strip-based process. The resulting transistor shows extremely high packing density for low on-resistance, rugged avalanche characteristics and less critical alignment steps therefore a remarkable manufacturing reproducibility.

## APPLICATIONS

- SOLENOID AND RELAY DRIVERS
- MOTOR CONTROL, AUDIO AMPLIFIERS
- DC-DC CONVERTERS
- AUTOMOTIVE ENVIRONMENT

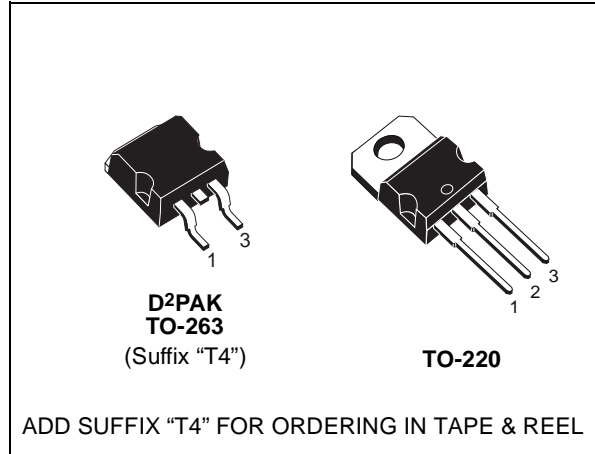

## INTERNAL SCHEMATIC DIAGRAM

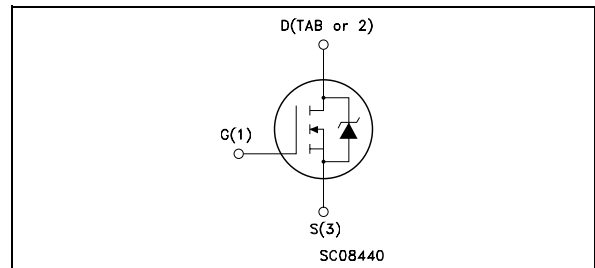

## Ordering Information

SALES TYPE	MARKING	PACKAGE	PACKAGING
STP85NF55L	P85NF55L	TO-220	TUBE
STB85NF55L	B85NF55L	D <sup>2</sup> PAK	TUBE
STB85NF55LT4	B85NF55L	D <sup>2</sup> PAK	TAPE & REEL

## ABSOLUTE MAXIMUM RATINGS

Symbol	Parameter	Value	Unit
V <sub>DS</sub>	Drain-source Voltage (V <sub>GS</sub> = 0)	55	V
V <sub>DGR</sub>	Drain-gate Voltage (R <sub>GS</sub> = 20 kΩ)	55	V
V <sub>GS</sub>	Gate- source Voltage	± 15	V
I <sub>D(●)</sub>	Drain Current (continuous) at T <sub>C</sub> = 25°C	80	A
I <sub>D</sub>	Drain Current (continuous) at T <sub>C</sub> = 100°C	80	A
I <sub>DM(●●)</sub>	Drain Current (pulsed)	320	A
P <sub>tot</sub>	Total Dissipation at T <sub>C</sub> = 25°C	300	W
	Derating Factor	2.0	W/°C
dv/dt (1)	Peak Diode Recovery voltage slope	10	V/ns
E <sub>AS</sub> (2)	Single Pulse Avalanche Energy	980	mJ
T <sub>stg</sub>	Storage Temperature	-55 to 175	°C
T <sub>j</sub>	Max. Operating Junction Temperature		

(●) Current Limited by Package.

(●●) Pulse width limited by safe operating area.

1) I<sub>SD</sub> ≤ 80A, di/dt ≤ 300A/μs, V<sub>DD</sub> ≤ V(BR)DSS, T<sub>j</sub> ≤ T<sub>JMAX</sub>

2) Starting T<sub>j</sub> = 25 °C, I<sub>D</sub> = 40A, V<sub>DD</sub> = 30V

## STB85NF55L STP85NF55L

### THERMAL DATA

Rthj-case	Thermal Resistance Junction-case	Max	0.5	°C/W
Rthj-amb	Thermal Resistance Junction-ambient	Max	62.5	°C/W
T <sub>l</sub>	Maximum Lead Temperature For Soldering Purpose		300	°C

### ELECTRICAL CHARACTERISTICS (T<sub>case</sub> = 25 °C unless otherwise specified)

OFF

Symbol	Parameter	Test Conditions	Min.	Typ.	Max.	Unit
V <sub>(BR)DSS</sub>	Drain-source Breakdown Voltage	I <sub>D</sub> = 250 μA, V <sub>GS</sub> = 0	55			V
I <sub>DSS</sub>	Zero Gate Voltage Drain Current (V <sub>GS</sub> = 0)	V <sub>DS</sub> = Max Rating V <sub>DS</sub> = Max Rating T <sub>C</sub> = 125°C			1 10	μA μA
I <sub>GSS</sub>	Gate-body Leakage Current (V <sub>DS</sub> = 0)	V <sub>GS</sub> = ± 15 V			±100	nA

ON (\*)

Symbol	Parameter	Test Conditions	Min.	Typ.	Max.	Unit
V <sub>GS(th)</sub>	Gate Threshold Voltage	V <sub>DS</sub> = V <sub>GS</sub> I <sub>D</sub> = 250 μA	1	1.6	2.5	V
R <sub>DS(on)</sub>	Static Drain-source On Resistance	V <sub>GS</sub> = 10 V I <sub>D</sub> = 40 A V <sub>GS</sub> = 5 V I <sub>D</sub> = 40 A		0.0060 0.008	0.008 0.01	Ω Ω

DYNAMIC

Symbol	Parameter	Test Conditions	Min.	Typ.	Max.	Unit
g <sub>fs</sub> (*)	Forward Transconductance	V <sub>DS</sub> = 15V I <sub>D</sub> = 40 A		130		S
C <sub>iss</sub>	Input Capacitance	V <sub>DS</sub> = 25V f = 1 MHz V <sub>GS</sub> = 0		4050		pF
C <sub>oss</sub>	Output Capacitance			860		pF
C <sub>rss</sub>	Reverse Transfer Capacitance			300		pF

**ELECTRICAL CHARACTERISTICS** (continued)

**SWITCHING ON**

Symbol	Parameter	Test Conditions	Min.	Typ.	Max.	Unit
$t_{d(on)}$ $t_r$	Turn-on Delay Time Rise Time	$V_{DD} = 27.5\text{ V}$ $I_D = 40\text{ A}$ $R_G = 4.7\ \Omega$ $V_{GS} = 5\text{ V}$ (Resistive Load, Figure 3)		35 165		ns ns
$Q_g$ $Q_{gs}$ $Q_{gd}$	Total Gate Charge Gate-Source Charge Gate-Drain Charge	$V_{DD}=27.5\text{V}$ $I_D=80\text{A}$ $V_{GS}=5\text{V}$ (see test circuit, Figure 4)		80 20 45	110	nC nC nC

**SWITCHING OFF**

Symbol	Parameter	Test Conditions	Min.	Typ.	Max.	Unit
$t_{d(off)}$ $t_f$	Turn-off Delay Time Fall Time	$V_{DD} = 27.5\text{ V}$ $I_D = 40\text{ A}$ $R_G = 4.7\ \Omega$ , $V_{GS} = 5\text{ V}$ (Resistive Load, Figure 3)		70 55		ns ns

**SOURCE DRAIN DIODE**

Symbol	Parameter	Test Conditions	Min.	Typ.	Max.	Unit
$I_{SD}$ $I_{SDM} (\bullet)$	Source-drain Current Source-drain Current (pulsed)				80 320	A A
$V_{SD} (^*)$	Forward On Voltage	$I_{SD} = 80\text{ A}$ $V_{GS} = 0$			1.5	V
$t_{rr}$ $Q_{rr}$ $I_{RRM}$	Reverse Recovery Time Reverse Recovery Charge Reverse Recovery Current	$I_{SD} = 80\text{ A}$ $di/dt = 100\text{A}/\mu\text{s}$ $V_{DD} = 20\text{ V}$ $T_j = 150^\circ\text{C}$ (see test circuit, Figure 5)		80 240 6		ns nC A

(\*)Pulsed: Pulse duration = 300  $\mu\text{s}$ , duty cycle 1.5 %.  
 (•)Pulse width limited by safe operating area.

**Safe Operating Area**

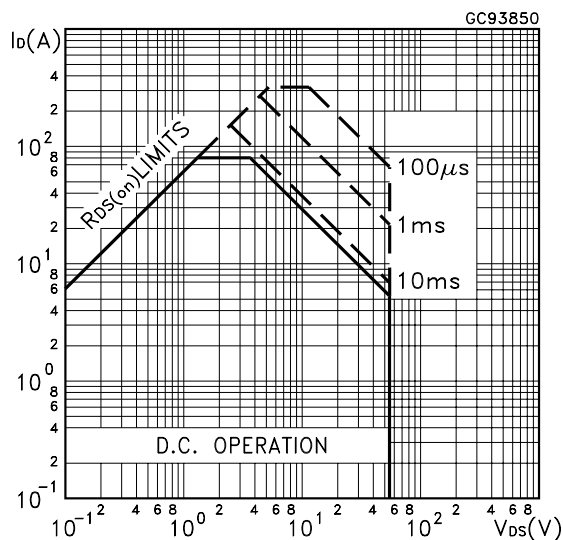

**Thermal Impedance**

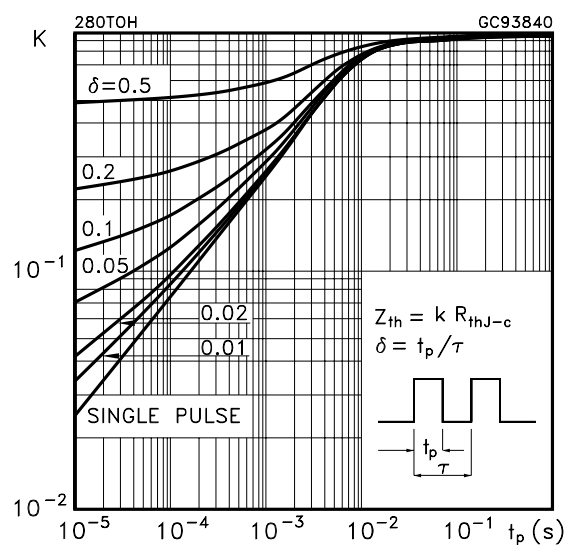

# STB85NF55L STP85NF55L

Output Characteristics

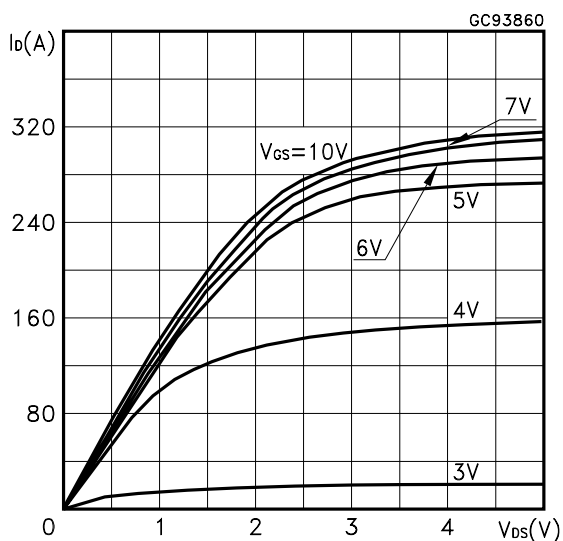

Transfer Characteristics

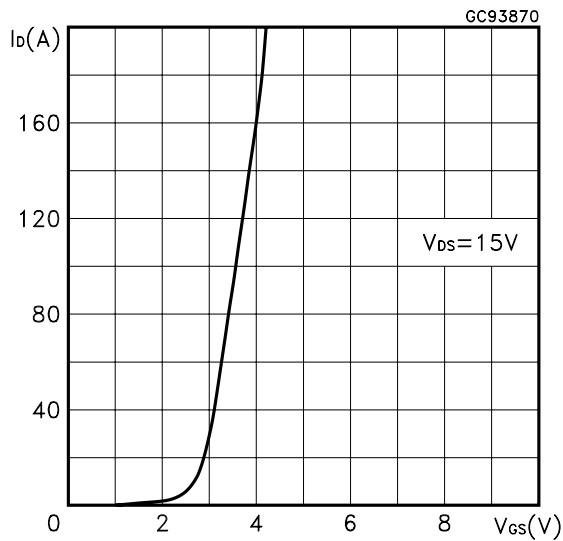

Transconductance

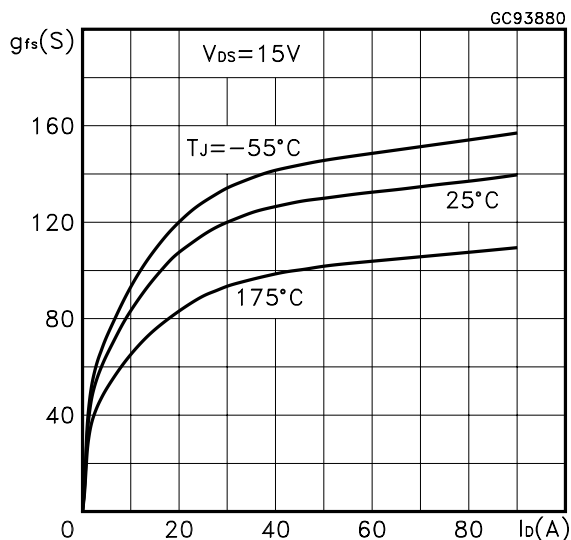

Static Drain-source On Resistance

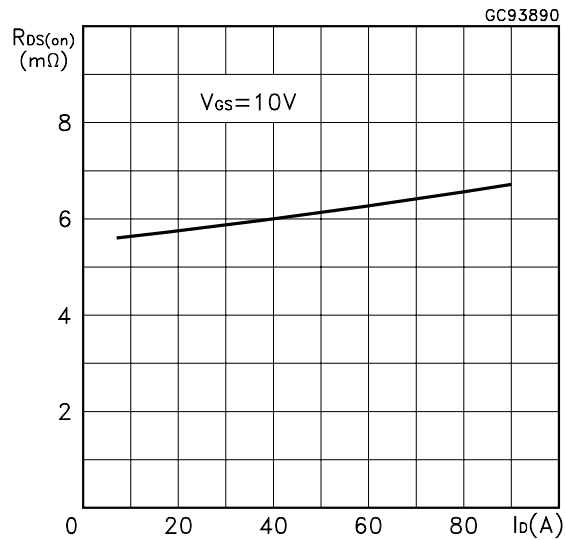

Gate Charge vs Gate-source Voltage

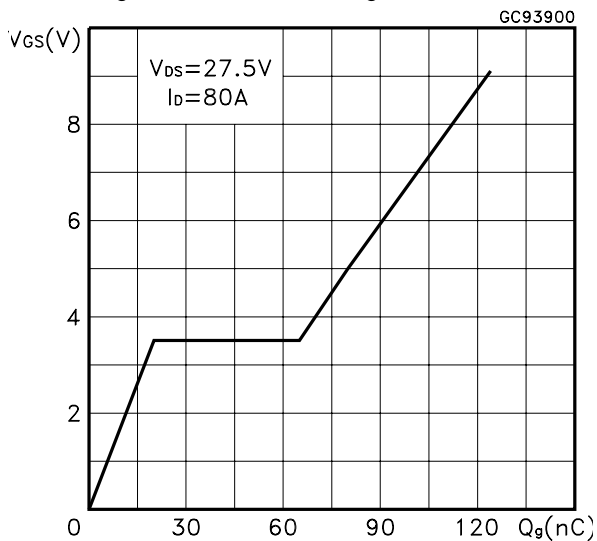

Capacitance Variations

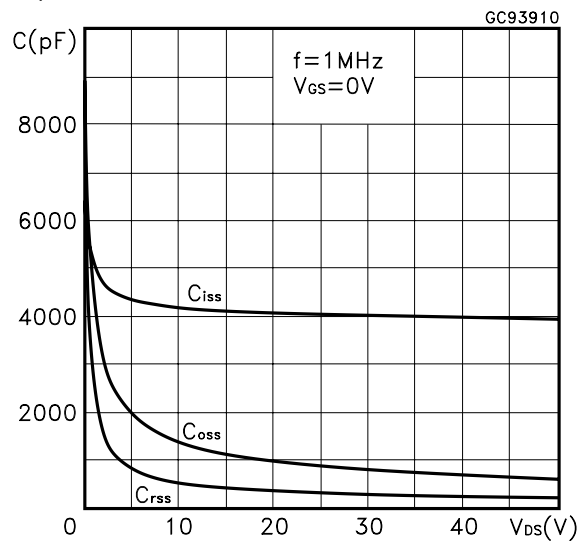

Normalized Gate Threshold Voltage vs Temperature

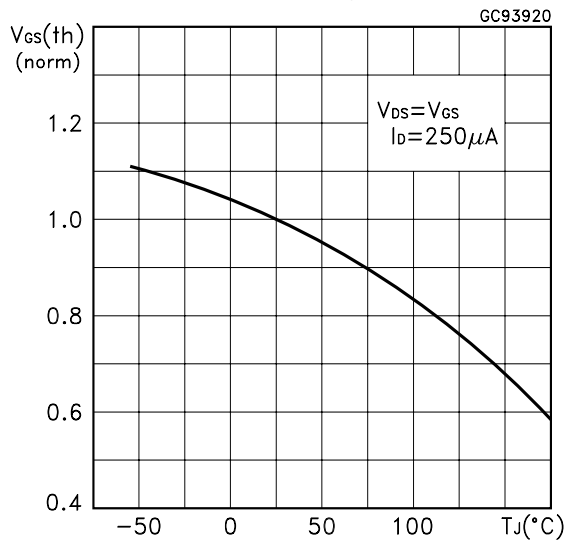

Normalized on Resistance vs Temperature

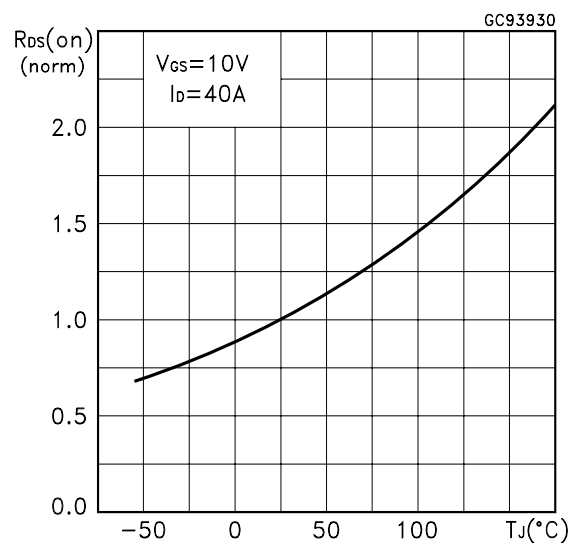

Source-drain Diode Forward Characteristics

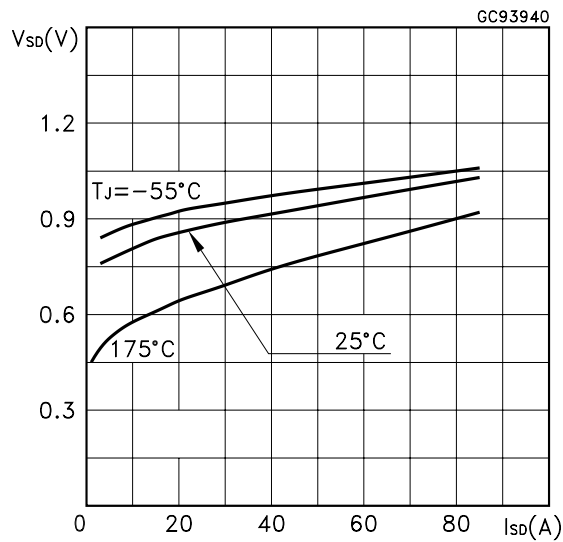

Normalized Breakdown Voltage vs Temperature.

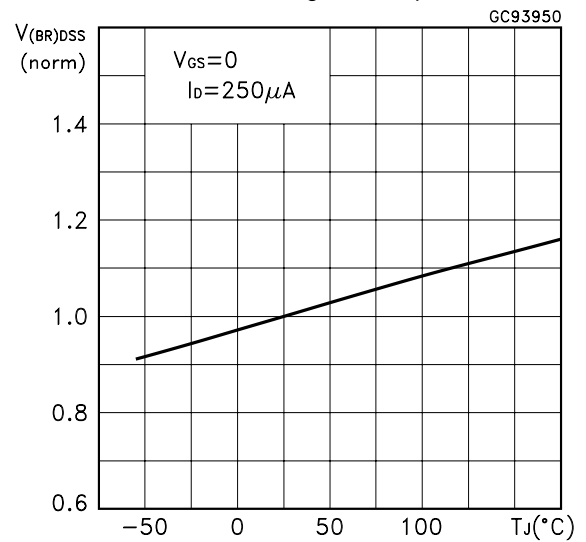

Fig. 1: Unclamped Inductive Load Test Circuit



Fig. 2: Unclamped Inductive Waveform



Fig. 3: Switching Times Test Circuits For Resistive Load



Fig. 4: Gate Charge test Circuit

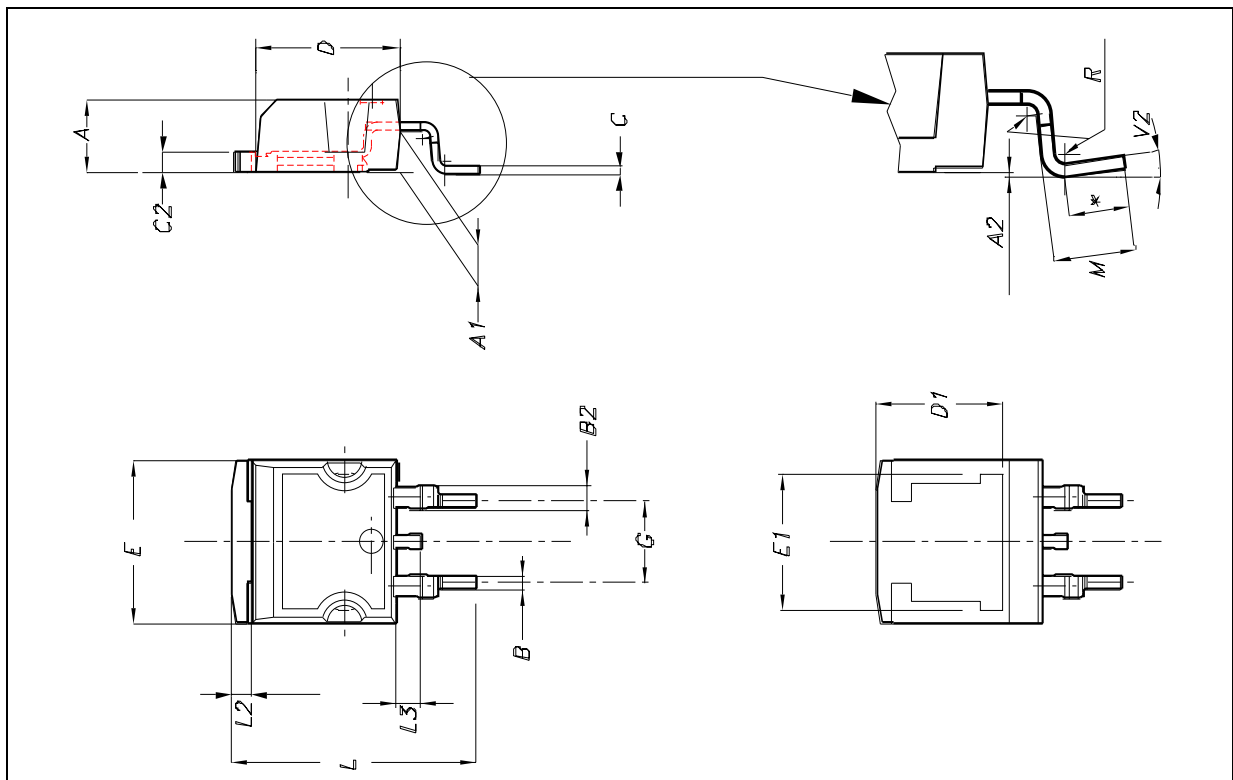

Fig. 5: Test Circuit For Inductive Load Switching And Diode Recovery Times



D<sup>2</sup>PAK MECHANICAL DATA

DIM.	mm.			inch.		
	MIN.	TYP.	MAX.	MIN.	TYP.	TYP.
A	4.4		4.6	0.173		0.181
A1	2.49		2.69	0.098		0.106
A2	0.03		0.23	0.001		0.009
B	0.7		0.93	0.028		0.037
B2	1.14		1.7	0.045		0.067
C	0.45		0.6	0.018		0.024
C2	1.21		1.36	0.048		0.054
D	8.95		9.35	0.352		0.368
D1	7.6	8	8.4	0.299	0.315	0.330
E	10		10.4	0.394		0.409
E1	8.1	8.5	8.9	0.318	0.334	0.350
G	4.88		5.28	0.192		0.208
L	15		15.85	0.591		0.624
L2	1.27		1.4	0.050		0.055
L3	1.4		1.75	0.055		0.069
M	2.4		3.2	0.094		0.126
R	0.3	0.4	0.5	0.012	0.016	0.019
V2	0°		8°	0°		8°



**TO-220 MECHANICAL DATA**

DIM.	mm.			inch.		
	MIN.	TYP.	MAX.	MIN.	TYP.	TYP.
A	4.4		4.6	0.173		0.181
C	1.23		1.32	0.048		0.051
D	2.40		2.72	0.094		0.107
D1		1.27			0.050	
E	0.49		0.70	0.019		0.027
F	0.61		0.88	0.024		0.034
F1	1.14		1.70	0.044		0.067
F2	1.14		1.70	0.044		0.067
G	4.95		5.15	0.194		0.203
G1	2.40		2.70	0.094		0.106
H2	10		10.40	0.393		0.409
L2	16.10	16.40	16.73	0.633	0.645	0.658
L4	13		14	0.511		0.551
L5	2.65		2.95	0.104		0.116
L6	15.25		15.75	0.600		0.620
L7	6.20		6.60	0.244		0.260
L9	3.50		3.93	0.137		0.154
DIA	3.75		3.85	0.147		0.151

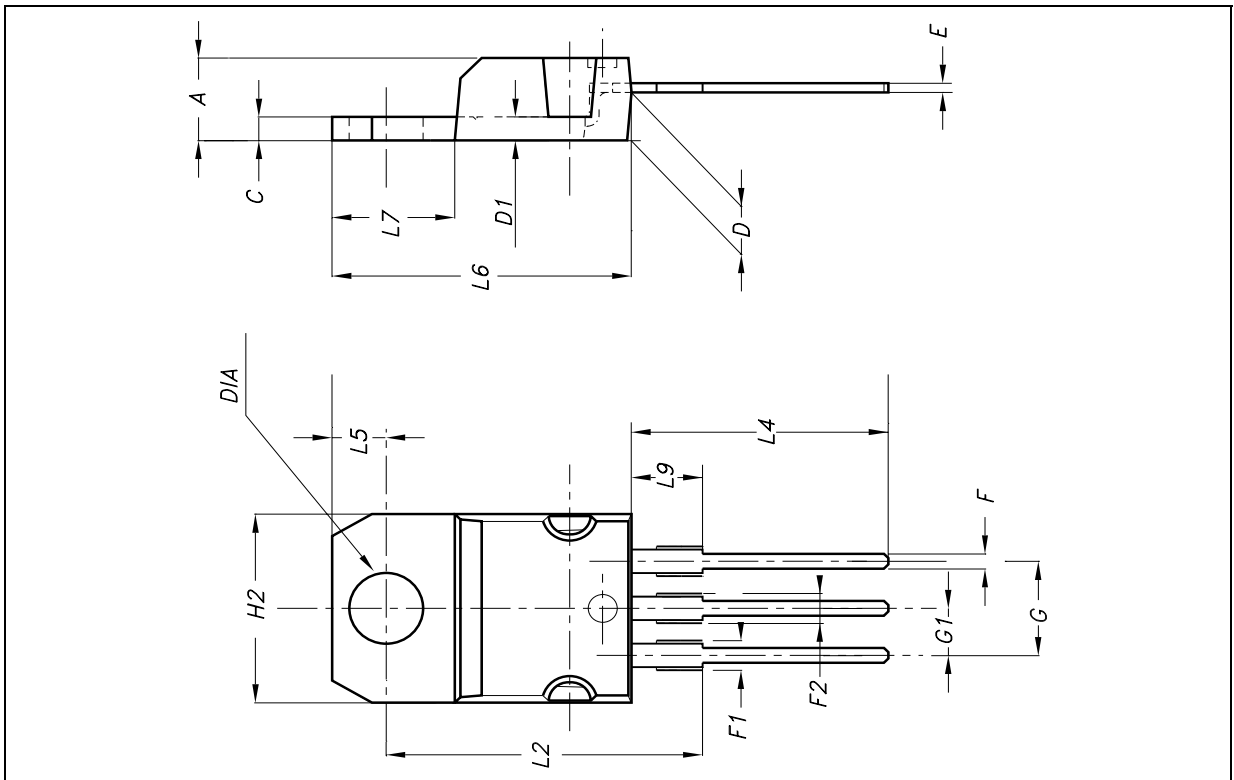



**D2PAK FOOTPRINT**

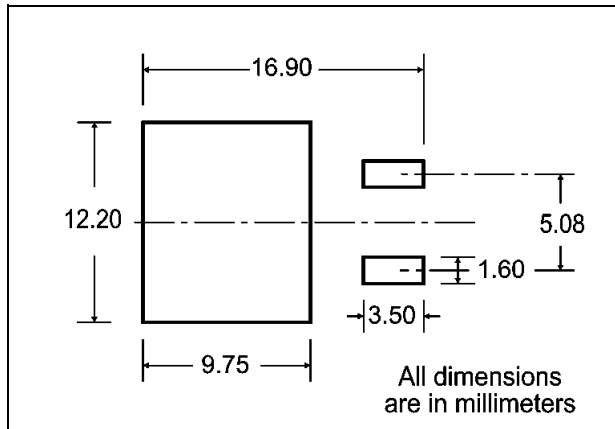

**TUBE SHIPMENT (no suffix)\***

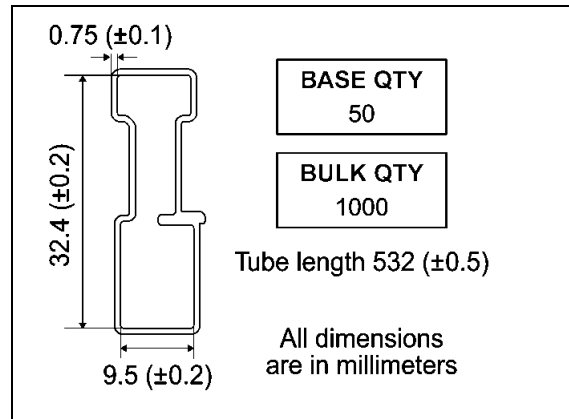

**TAPE AND REEL SHIPMENT (suffix "T4")\***

40 mm min. Access hole at slot location

Full radius

Tape slot in core for tape start 2.5mm min. width

T

C

N

G measured at hub

**REEL MECHANICAL DATA**

DIM.	mm		inch	
	MIN.	MAX.	MIN.	MAX.
A		330		12.992
B	1.5		0.059	
C	12.8	13.2	0.504	0.520
D	20.2		0.795	
G	24.4	26.4	0.960	1.039
N	100		3.937	
T		30.4		1.197

BASE QTY	BULK QTY
1000	1000

**TAPE MECHANICAL DATA**

DIM.	mm		inch	
	MIN.	MAX.	MIN.	MAX.
A0	10.5	10.7	0.413	0.421
B0	15.7	15.9	0.618	0.626
D	1.5	1.6	0.059	0.063
D1	1.59	1.61	0.062	0.063
E	1.65	1.85	0.065	0.073
F	11.4	11.6	0.449	0.456
K0	4.8	5.0	0.189	0.197
P0	3.9	4.1	0.153	0.161
P1	11.9	12.1	0.468	0.476
P2	1.9	2.1	0.075	0.082
R	50		1.574	
T	0.25	0.35	0.0098	0.0137
W	23.7	24.3	0.933	0.956

TOP COVER TAPE

10 pitches cumulative tolerance on tape +/- 0.2 mm

Center line of cavity

User Direction of Feed

TRL

FEED DIRECTION

Bending radius

R min.

\* on sales type



Information furnished is believed to be accurate and reliable. However, STMicroelectronics assumes no responsibility for the consequences of use of such information nor for any infringement of patents or other rights of third parties which may result from its use. No license is granted by implication or otherwise under any patent or patent rights of STMicroelectronics. Specifications mentioned in this publication are subject to change without notice. This publication supersedes and replaces all information previously supplied. STMicroelectronics products are not authorized for use as critical components in life support devices or systems without express written approval of STMicroelectronics.

The ST logo is registered trademark of STMicroelectronics  
© 2002 STMicroelectronics - All Rights Reserved

All other names are the property of their respective owners.

STMicroelectronics GROUP OF COMPANIES  
Australia - Brazil - Canada - China - Finland - France - Germany - Hong Kong - India - Israel - Italy - Japan - Malaysia - Malta - Morocco -  
Singapore - Spain - Sweden - Switzerland - United Kingdom - United States.

<http://www.st.com>