



# STD25NF10

## N-CHANNEL 100V - 0.033Ω - 25A DPAK LOW GATE CHARGE STripFET™ POWER MOSFET

TYPE	V <sub>DSS</sub>	R <sub>DS(on)</sub>	I <sub>D</sub>
STD25NF10	100 V	< 0.038 Ω	25 A

- TYPICAL R<sub>DS(on)</sub> = 0.033Ω
- EXCEPTIONAL dv/dt CAPABILITY
- 100% AVALANCHE TESTED
- APPLICATION ORIENTED CHARACTERIZATION

### DESCRIPTION

This Power Mosfet series realized with STMicroelectronics unique STripFET process has specifically been designed to minimize input capacitance and gate charge. It is therefore suitable as primary switch in advanced high-efficiency isolated DC-DC converters for Telecom and Computer application. It is also intended for any application with low gate charge drive requirements.

### APPLICATIONS

- HIGH-EFFICIENCY DC-DC CONVERTERS
- UPS AND MOTOR CONTROL

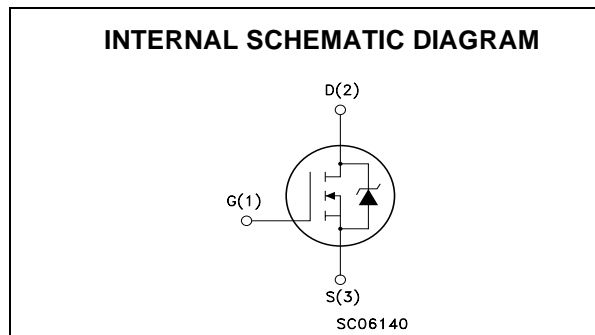
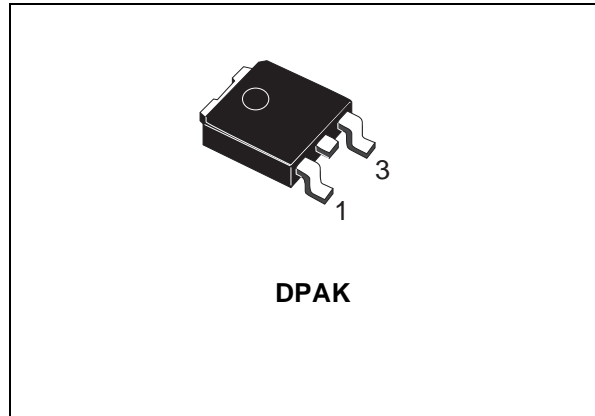

### ABSOLUTE MAXIMUM RATINGS

Symbol	Parameter	Value	Unit
V <sub>DS</sub>	Drain-source Voltage (V <sub>GS</sub> = 0)	100	V
V <sub>DGR</sub>	Drain-gate Voltage (R <sub>GS</sub> = 20 kΩ)	100	V
V <sub>GS</sub>	Gate- source Voltage	± 20	V
I <sub>D</sub> (*)	Drain Current (continuous) at T <sub>C</sub> = 25°C	25	A
I <sub>D</sub>	Drain Current (continuous) at T <sub>C</sub> = 100°C	21	A
I <sub>DM</sub> (●)	Drain Current (pulsed)	100	A
P <sub>TOT</sub>	Total Dissipation at T <sub>C</sub> = 25°C	100	W
	Derating Factor	0.67	W/°C
dv/dt (1)	Peak Diode Recovery voltage slope	13	V/ns
E <sub>AS</sub> (2)	Single Pulse Avalanche Energy	480	mJ
T <sub>stg</sub>	Storage Temperature	-55 to 175	°C
T <sub>j</sub>	Operating Junction Temperature		

(●) Pulse width limited by safe operating area  
 (\*) Current Limited by Package

(1) I<sub>SD</sub> ≤ 35A, di/dt ≤ 300A/μs, V<sub>DD</sub> ≤ V<sub>(BR)DSS</sub>, T<sub>j</sub> ≤ T<sub>JMAX</sub>.  
 (2) Starting T<sub>j</sub> = 25°C, I<sub>D</sub> = 12.5A, V<sub>DD</sub> = 50V

## STD25NF10

### THERMAL DATA

Rthj-case	Thermal Resistance Junction-case Max	1.5	°C/W
Rthj-amb	Thermal Resistance Junction-ambient Max	100	°C/W
T <sub>l</sub>	Maximum Lead Temperature For Soldering Purpose	300	°C

### ELECTRICAL CHARACTERISTICS (TCASE = 25 °C UNLESS OTHERWISE SPECIFIED)

OFF

Symbol	Parameter	Test Conditions	Min.	Typ.	Max.	Unit
V <sub>(BR)DSS</sub>	Drain-source Breakdown Voltage	I <sub>D</sub> = 250 μA, V <sub>GS</sub> = 0	100			V
I <sub>DSS</sub>	Zero Gate Voltage Drain Current (V <sub>GS</sub> = 0)	V <sub>DS</sub> = Max Rating V <sub>DS</sub> = Max Rating, T <sub>C</sub> = 125 °C			1 10	μA μA
I <sub>GSS</sub>	Gate-body Leakage Current (V <sub>DS</sub> = 0)	V <sub>GS</sub> = ±20V			±100	nA

ON (1)

Symbol	Parameter	Test Conditions	Min.	Typ.	Max.	Unit
V <sub>GS(th)</sub>	Gate Threshold Voltage	V <sub>DS</sub> = V <sub>GS</sub> , I <sub>D</sub> = 250μA	2	3	4	V
R <sub>DS(on)</sub>	Static Drain-source On Resistance	V <sub>GS</sub> = 10V, I <sub>D</sub> = 12.5 A		0.033	0.038	Ω

DYNAMIC

Symbol	Parameter	Test Conditions	Min.	Typ.	Max.	Unit
g <sub>fs</sub> (1)	Forward Transconductance	V <sub>DS</sub> = 15 V, I <sub>D</sub> = 12.5 A		20		S
C <sub>iss</sub>	Input Capacitance	V <sub>DS</sub> = 25V, f = 1 MHz, V <sub>GS</sub> = 0		1550		pF
C <sub>oss</sub>	Output Capacitance			220		pF
C <sub>rss</sub>	Reverse Transfer Capacitance			95		pF

**ELECTRICAL CHARACTERISTICS (CONTINUED)**

**SWITCHING ON**

Symbol	Parameter	Test Conditions	Min.	Typ.	Max.	Unit
$t_{d(on)}$	Turn-on Delay Time	$V_{DD} = 50V, I_D = 12.5 A$ $R_G = 4.7\Omega, V_{GS} = 10V$ (see test circuit, Figure 3)		17		ns
$t_r$	Rise Time			60		ns
$Q_g$	Total Gate Charge	$V_{DD} = 80V, I_D = 25A, V_{GS} = 10V$		55		nC
$Q_{gs}$	Gate-Source Charge			12		nC
$Q_{gd}$	Gate-Drain Charge			20		nC

**SWITCHING OFF**

Symbol	Parameter	Test Conditions	Min.	Typ.	Max.	Unit
$t_{d(off)}$	Turn-off-Delay Time	$V_{DD} = 50V, I_D = 12.5 A,$ $R_G = 4.7\Omega, V_{GS} = 10V$ (see test circuit, Figure 3)		60		ns
$t_f$	Fall Time			15		ns

**SOURCE DRAIN DIODE**

Symbol	Parameter	Test Conditions	Min.	Typ.	Max.	Unit
$I_{SD}$	Source-drain Current				25	A
$I_{SDM} (1)$	Source-drain Current (pulsed)				100	A
$V_{SD} (2)$	Forward On Voltage	$I_{SD} = 25 A, V_{GS} = 0$			1.5	V
$t_{rr}$	Reverse Recovery Time	$I_{SD} = 25 A, di/dt = 100A/\mu s,$ $V_{DD} = 50V, T_j = 150^\circ C$ (see test circuit, Figure 5)		160		ns
$Q_{rr}$	Reverse Recovery Charge					nC
$I_{RRM}$	Reverse Recovery Current					A

Note: 1. Pulsed: Pulse duration = 300  $\mu s$ , duty cycle 1.5 %.  
2. Pulse width limited by safe operating area.

**Safe Operating Area**

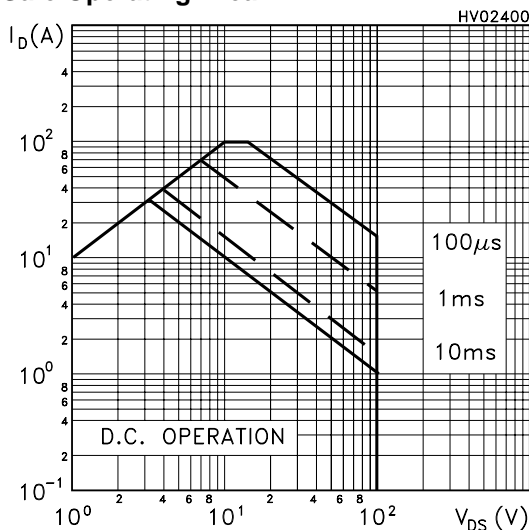

**Thermal Impedence**

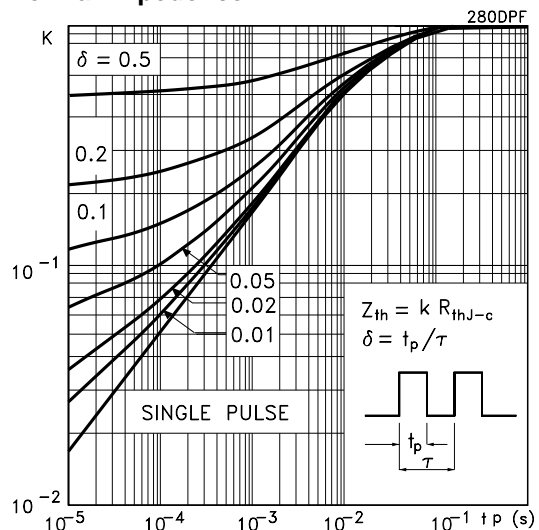

Output Characteristics

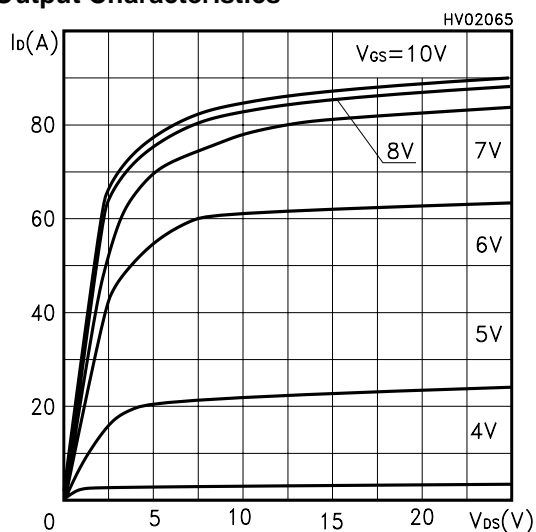

Transfer Characteristics

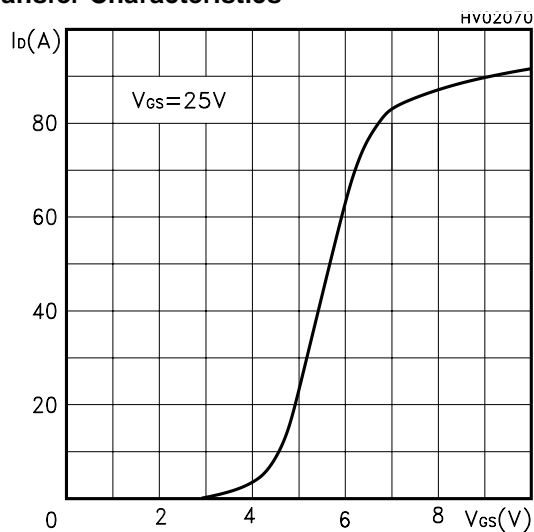

Transconductance

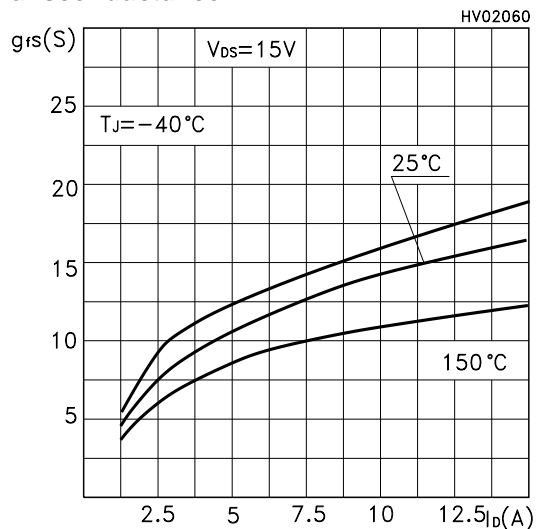

Static Drain-source On Resistance

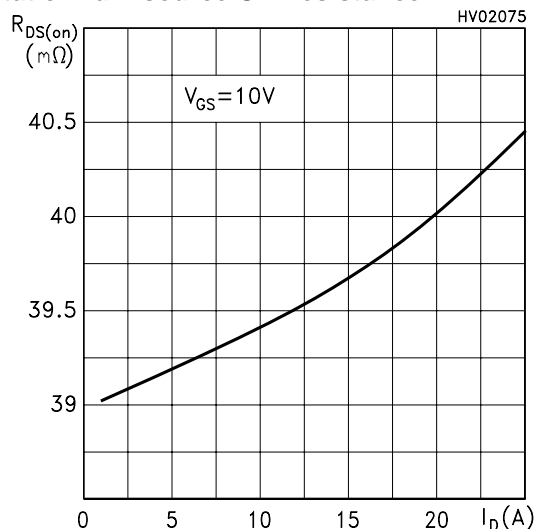

Gate Charge vs Gate-source Voltage

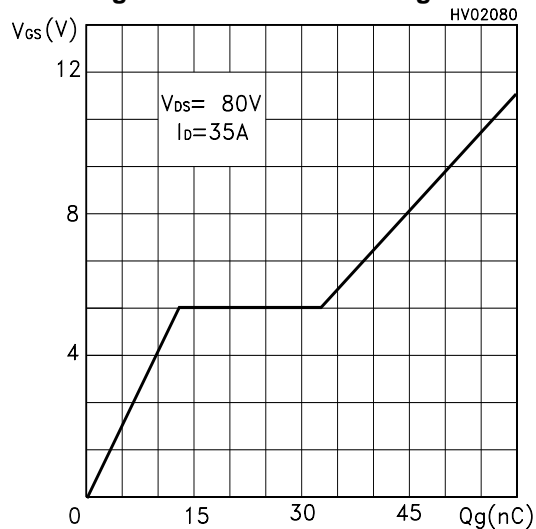

Capacitance Variations

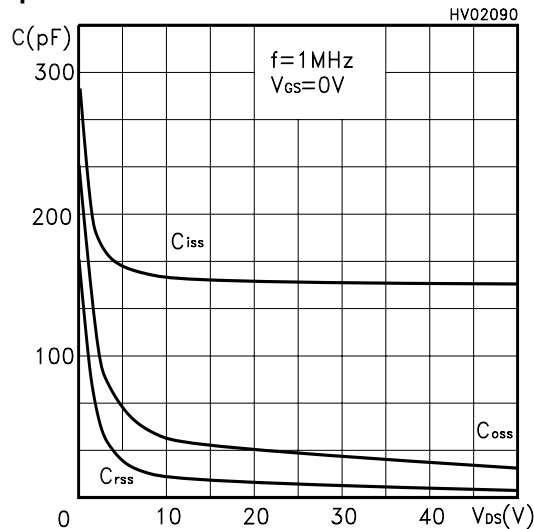

Normalized Gate Threshold Voltage vs Temp. HV02095

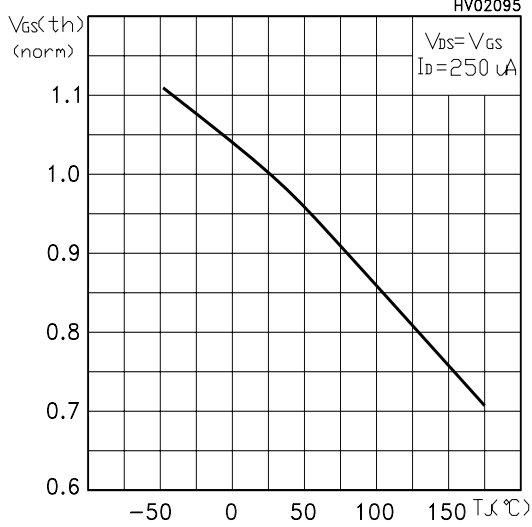

Normalized On Resistance vs Temperature HV01920

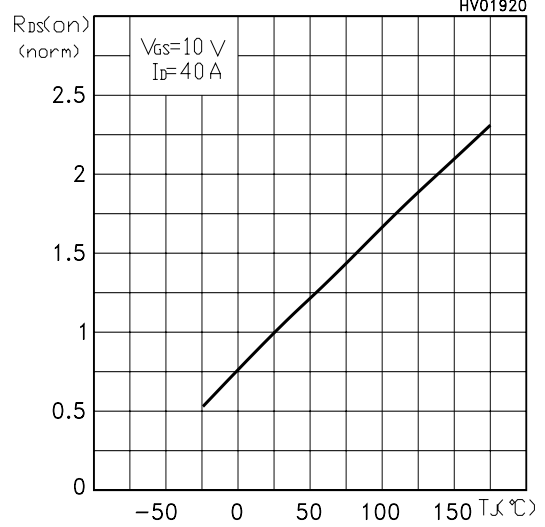

Source-drain Diode Forward Characteristics HV02105

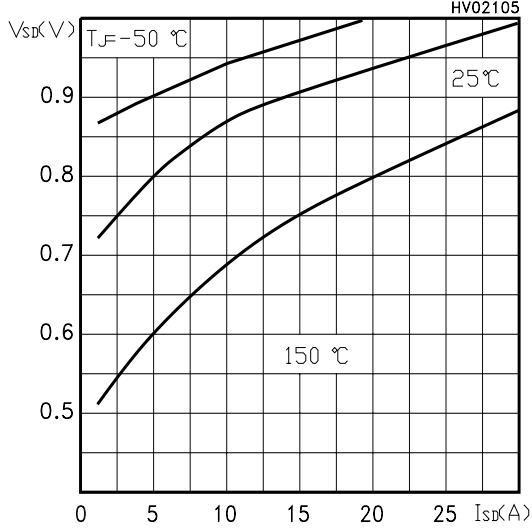



TO-252 (DPAK) MECHANICAL DATA

DIM.	mm			inch		
	MIN.	TYP.	MAX.	MIN.	TYP.	MAX.
A	2.20		2.40	0.087		0.094
A1	0.90		1.10	0.035		0.043
A2	0.03		0.23	0.001		0.009
B	0.64		0.90	0.025		0.035
B2	5.20		5.40	0.204		0.213
C	0.45		0.60	0.018		0.024
C2	0.48		0.60	0.019		0.024
D	6.00		6.20	0.236		0.244
E	6.40		6.60	0.252		0.260
G	4.40		4.60	0.173		0.181
H	9.35		10.10	0.368		0.398
L2		0.8			0.031	
L4	0.60		1.00	0.024		0.039
V2	0°		8°	0°		0°

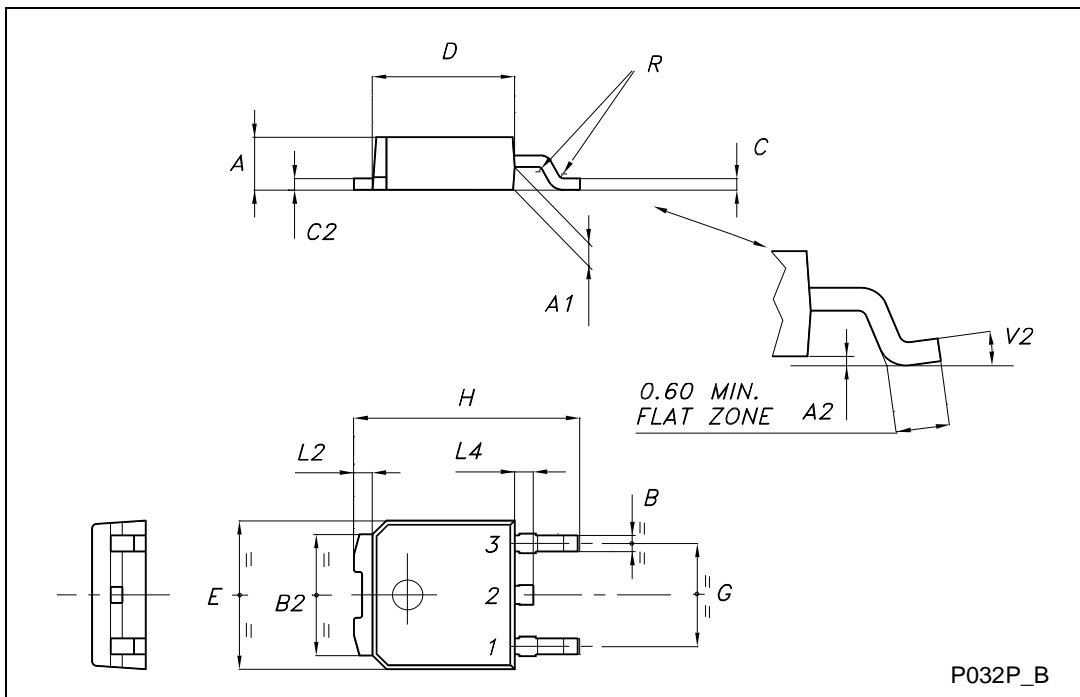

**DPAK FOOTPRINT**

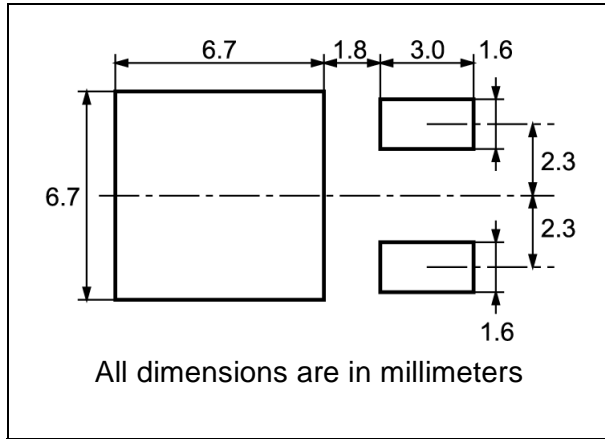

**TUBE SHIPMENT (no suffix)\***

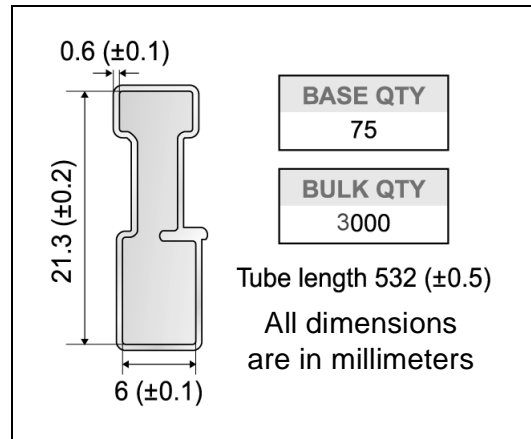

**TAPE AND REEL SHIPMENT (suffix "T4")\***

40 mm min. Access hole at slot location

Full radius

Tape slot in core for tape start 2.5mm min. width

**REEL MECHANICAL DATA**

DIM.	mm		inch	
	MIN.	MAX.	MIN.	MAX.
A		330		12.992
B	1.5		0.059	
C	12.8	13.2	0.504	0.520
D	20.2		0.795	
G	16.4	18.4	0.645	0.724
N	50		1.968	
T		22.4		0.881

BASE QTY	BULK QTY
2500	2500

**TAPE MECHANICAL DATA**

DIM.	mm		inch	
	MIN.	MAX.	MIN.	MAX.
A0	6.8	7	0.267	0.275
B0	10.4	10.6	0.409	0.417
B1		12.1		0.476
D	1.5	1.6	0.059	0.063
D1	1.5		0.059	
E	1.65	1.85	0.065	0.073
F	7.4	7.6	0.291	0.299
K0	2.55	2.75	0.100	0.108
P0	3.9	4.1	0.153	0.161
P1	7.9	8.1	0.311	0.319
P2	1.9	2.1	0.075	0.082
R	40		1.574	
W	15.7	16.3	0.618	0.641

TOP COVER TAPE

User Direction of Feed

Center line of cavity

Bending radius R min.

For machine ref. only including draft and radii concentric around B0

FEED DIRECTION

\* on sales type



Information furnished is believed to be accurate and reliable. However, STMicroelectronics assumes no responsibility for the consequences of use of such information nor for any infringement of patents or other rights of third parties which may result from its use. No license is granted by implication or otherwise under any patent or patent rights of STMicroelectronics. Specifications mentioned in this publication are subject to change without notice. This publication supersedes and replaces all information previously supplied. STMicroelectronics products are not authorized for use as critical components in life support devices or systems without express written approval of STMicroelectronics.

© The ST logo is a registered trademark of STMicroelectronics

© 2002 STMicroelectronics - Printed in Italy - All Rights Reserved  
STMicroelectronics GROUP OF COMPANIES

Australia - Brazil - Canada - China - Finland - France - Germany - Hong Kong - India - Israel - Italy - Japan - Malaysia - Malta - Morocco  
Singapore - Spain - Sweden - Switzerland - United Kingdom - United States.

© <http://www.st.com>