



## SMALL SIGNAL NPN TRANSISTOR

PRELIMINARY DATA

Type	Marking
STPSA42	PSA42

- SILICON EPITAXIAL PLANAR NPN HIGH VOLTAGE TRANSISTOR
- TO-92 PACKAGE SUITABLE FOR THROUGH-HOLE PCB ASSEMBLY
- THE PNP COMPLEMENTARY TYPE IS STPSA92

### APPLICATIONS

- VIDEO AMPLIFIER CIRCUITS (RGB CATHODE CURRENT CONTROL)
- TELEPHONE WIRELINE INTERFACE (HOOK SWITCHES, DIALER CIRCUITS)

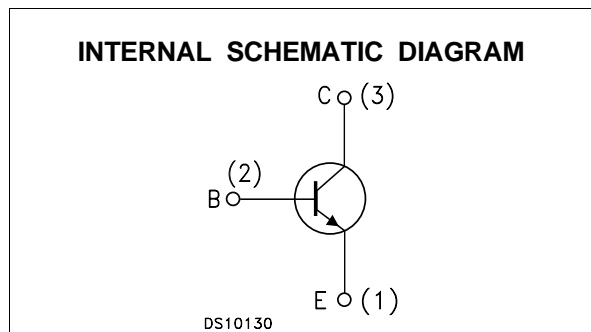
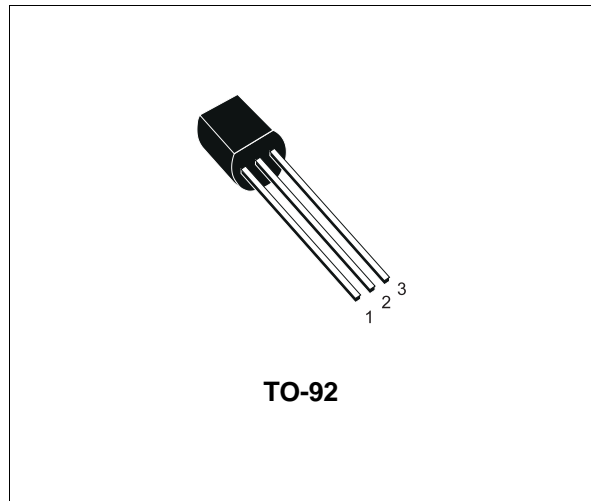

### ABSOLUTE MAXIMUM RATINGS

Symbol	Parameter	Value	Unit
$V_{CBO}$	Collector-Base Voltage ( $I_E = 0$ )	300	V
$V_{CEO}$	Collector-Emitter Voltage ( $I_B = 0$ )	300	V
$V_{EBO}$	Emitter-Base Voltage ( $I_C = 0$ )	5	V
$I_C$	Collector Current	0.5	A
$I_{CM}$	Collector Peak Current	0.6	A
$P_{tot}$	Total Dissipation at $T_C = 25\text{ }^\circ\text{C}$	625	mW
$T_{stg}$	Storage Temperature	-65 to 150	$^\circ\text{C}$
$T_j$	Max. Operating Junction Temperature	150	$^\circ\text{C}$

## STPSA42

### THERMAL DATA

$R_{thj-amb}$	Thermal Resistance Junction-Ambient	Max	200	$^{\circ}\text{C}/\text{W}$
$R_{thj-case}$	Thermal Resistance Junction-Case	Max	83.3	$^{\circ}\text{C}/\text{W}$

### ELECTRICAL CHARACTERISTICS ( $T_{case} = 25^{\circ}\text{C}$ unless otherwise specified)

Symbol	Parameter	Test Conditions	Min.	Typ.	Max.	Unit
$I_{CBO}$	Collector Cut-off Current ( $I_E = 0$ )	$V_{CB} = 200\text{ V}$			100	nA
$V_{(BR)CBO}$	Collector-Base Breakdown Voltage ( $I_E = 0$ )	$I_C = 100\ \mu\text{A}$	300			V
$V_{(BR)CEO}^*$	Collector-Emitter Breakdown Voltage ( $I_B = 0$ )	$I_C = 1\text{ mA}$	300			V
$V_{(BR)EBO}$	Emitter-Base Breakdown Voltage ( $I_C = 0$ )	$I_E = 100\ \mu\text{A}$	5			V
$V_{CE(sat)}^*$	Collector-Emitter Saturation Voltage	$I_C = 20\text{ mA}$ $I_B = 2\text{ mA}$			0.5	V
$V_{BE(sat)}^*$	Base-Emitter Saturation Voltage	$I_C = 20\text{ mA}$ $I_B = 2\text{ mA}$			0.9	V
$h_{FE}^*$	DC Current Gain	$I_C = 1\text{ mA}$ $V_{CE} = 10\text{ V}$ $I_C = 10\text{ mA}$ $V_{CE} = 10\text{ V}$ $I_C = 30\text{ mA}$ $V_{CE} = 10\text{ V}$	25 40 40			
$f_T$	Transition Frequency	$I_C = 10\text{ mA}$ $V_{CE} = 20\text{ V}$ $f = 20\text{ MHz}$	50			MHz
$C_{CBO}$	Collector-Base Capacitance	$I_E = 0$ $V_{CB} = 10\text{ V}$ $f = 1\text{ MHz}$		6		pF
$C_{EBO}$	Emitter-Base Capacitance	$I_C = 0$ $V_{EB} = 2\text{ V}$ $f = 1\text{ MHz}$		22		pF

\* Pulsed: Pulse duration = 300  $\mu\text{s}$ , duty cycle  $\leq 1.5\%$

## TO-92 MECHANICAL DATA

DIM.	mm			inch		
	MIN.	TYP.	MAX.	MIN.	TYP.	MAX.
A	4.32		4.95	0.170		0.195
b	0.36		0.51	0.014		0.020
D	4.45		4.95	0.175		0.194
E	3.30		3.94	0.130		0.155
e	2.41		2.67	0.095		0.105
e1	1.14		1.40	0.045		0.055
L	12.70		15.49	0.500		0.609
R	2.16		2.41	0.085		0.094
S1	1.14		1.52	0.045		0.059
W	0.41		0.56	0.016		0.022
V	4 degree		6 degree	4 degree		6 degree

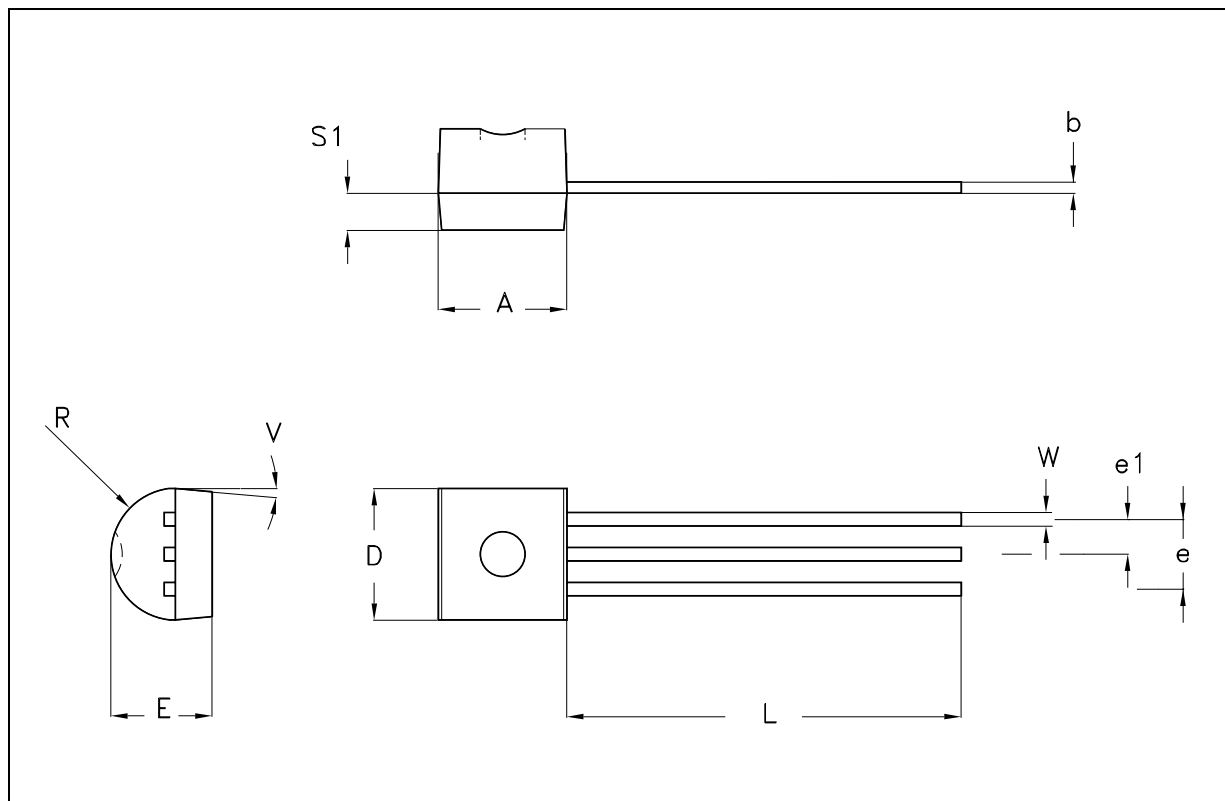

Information furnished is believed to be accurate and reliable. However, STMicroelectronics assumes no responsibility for the consequences of use of such information nor for any infringement of patents or other rights of third parties which may result from its use. No license is granted by implication or otherwise under any patent or patent rights of STMicroelectronics. Specification mentioned in this publication are subject to change without notice. This publication supersedes and replaces all information previously supplied. STMicroelectronics products are not authorized for use as critical components in life support devices or systems without express written approval of STMicroelectronics.

The ST logo is a trademark of STMicroelectronics

© 2002 STMicroelectronics – Printed in Italy – All Rights Reserved

STMicroelectronics GROUP OF COMPANIES

Australia - Brazil - Canada - China - Finland - France - Germany - Hong Kong - India - Israel - Italy - Japan - Malaysia - Malta - Morocco - Singapore - Spain - Sweden - Switzerland - United Kingdom - United States.

<http://www.st.com>