



SMALL SIGNAL PNP TRANSISTOR

PRELIMINARY DATA

Type	Marking
STPSA92	PSA92

- SILICON EPITAXIAL PLANAR PNP HIGH VOLTAGE TRANSISTOR
- TO-92 PACKAGE SUITABLE FOR THROUGH-HOLE PCB ASSEMBLY
- THE NPN COMPLEMENTARY TYPE IS STPSA42

APPLICATIONS

- VIDEO AMPLIFIER CIRCUITS (RGB CATHODE CURRENT CONTROL)
- TELEPHONE WIRELINE INTERFACE (HOOK SWITCHES, DIALER CIRCUITS)

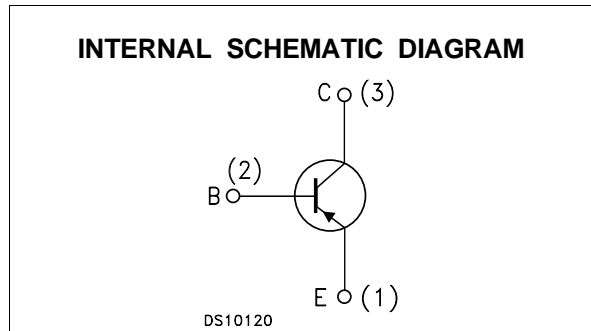
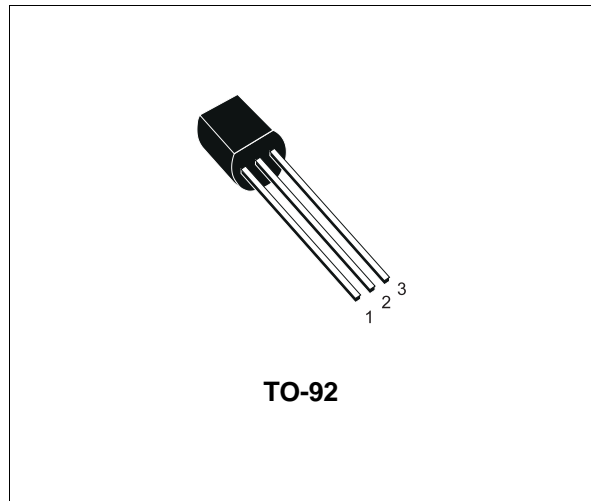

ABSOLUTE MAXIMUM RATINGS

Symbol	Parameter	Value	Unit
V_{CBO}	Collector-Base Voltage ($I_E = 0$)	-300	V
V_{CEO}	Collector-Emitter Voltage ($I_B = 0$)	-300	V
V_{EBO}	Emitter-Base Voltage ($I_C = 0$)	-5	V
I_C	Collector Current	-0.5	A
I_{CM}	Collector Peak Current	-0.6	A
P_{tot}	Total Dissipation at $T_C = 25\text{ }^\circ\text{C}$	625	mW
T_{stg}	Storage Temperature	-65 to 150	$^\circ\text{C}$
T_j	Max. Operating Junction Temperature	150	$^\circ\text{C}$

STPSA92

THERMAL DATA

$R_{thj-amb}$	Thermal Resistance Junction-Ambient	Max	200	$^{\circ}\text{C}/\text{W}$
$R_{thj-case}$	Thermal Resistance Junction-Case	Max	83.3	$^{\circ}\text{C}/\text{W}$

ELECTRICAL CHARACTERISTICS ($T_{case} = 25^{\circ}\text{C}$ unless otherwise specified)

Symbol	Parameter	Test Conditions	Min.	Typ.	Max.	Unit
I_{CBO}	Collector Cut-off Current ($I_E = 0$)	$V_{CB} = -200\text{ V}$			-100	nA
$V_{(BR)CBO}$	Collector-Base Breakdown Voltage ($I_E = 0$)	$I_C = -100\ \mu\text{A}$	-300			V
$V_{(BR)CEO}^*$	Collector-Emitter Breakdown Voltage ($I_B = 0$)	$I_C = -1\text{ mA}$	-300			V
$V_{(BR)EBO}$	Emitter-Base Breakdown Voltage ($I_C = 0$)	$I_E = -100\ \mu\text{A}$	-5			V
$V_{CE(sat)}^*$	Collector-Emitter Saturation Voltage	$I_C = -20\text{ mA}$ $I_B = -2\text{ mA}$			-0.5	V
$V_{BE(sat)}^*$	Base-Emitter Saturation Voltage	$I_C = -20\text{ mA}$ $I_B = -2\text{ mA}$			-0.9	V
h_{FE}^*	DC Current Gain	$I_C = -1\text{ mA}$ $V_{CE} = -10\text{ V}$ $I_C = -10\text{ mA}$ $V_{CE} = -10\text{ V}$ $I_C = -30\text{ mA}$ $V_{CE} = -10\text{ V}$	25 40 40			
f_T	Transition Frequency	$I_C = -10\text{ mA}$ $V_{CE} = -20\text{ V}$ $f = 50\text{ MHz}$	50			MHz
C_{CEO}	Collector-Emitter Capacitance	$V_{CE} = -20\text{ V}$ $f = 1\text{ MHz}$	50			pF

* Pulsed: Pulse duration = 300 μs , duty cycle $\leq 1.5\%$

TO-92 MECHANICAL DATA

DIM.	mm			inch		
	MIN.	TYP.	MAX.	MIN.	TYP.	MAX.
A	4.32		4.95	0.170		0.195
b	0.36		0.51	0.014		0.020
D	4.45		4.95	0.175		0.194
E	3.30		3.94	0.130		0.155
e	2.41		2.67	0.095		0.105
e1	1.14		1.40	0.045		0.055
L	12.70		15.49	0.500		0.609
R	2.16		2.41	0.085		0.094
S1	1.14		1.52	0.045		0.059
W	0.41		0.56	0.016		0.022
V	4 degree		6 degree	4 degree		6 degree

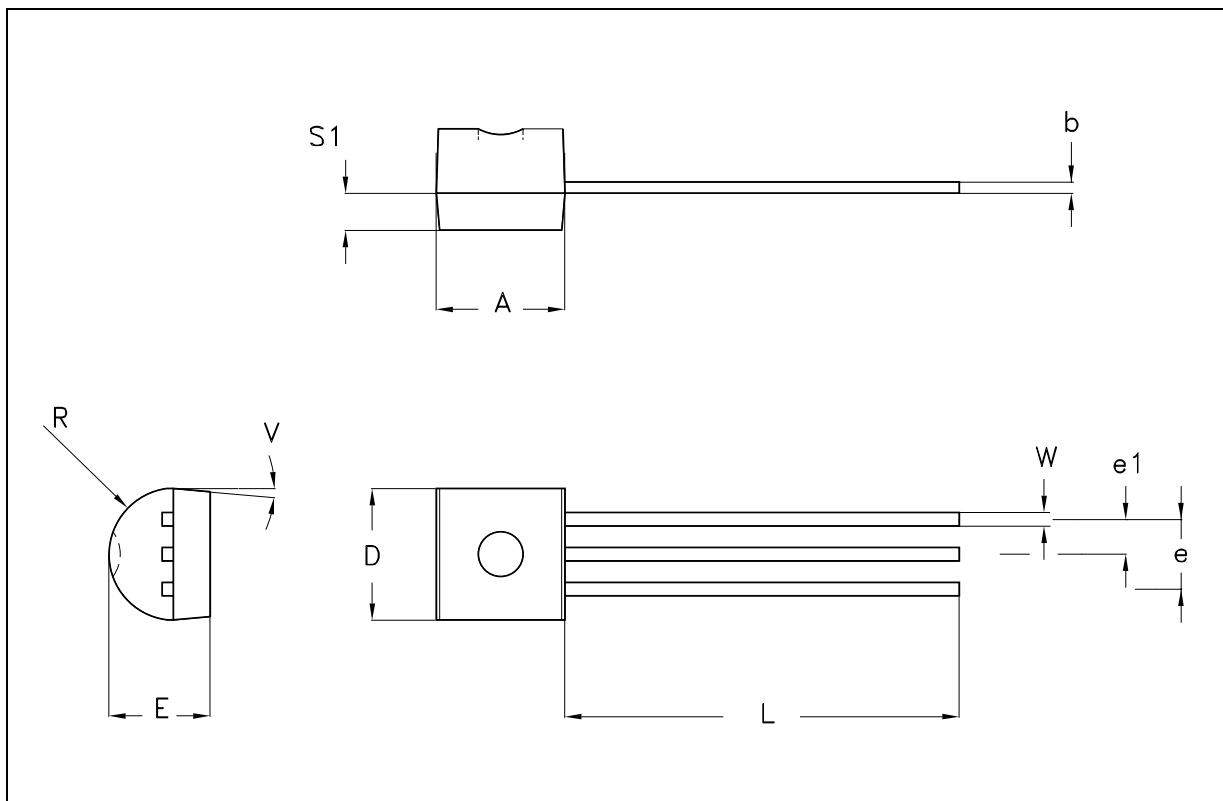

Information furnished is believed to be accurate and reliable. However, STMicroelectronics assumes no responsibility for the consequences of use of such information nor for any infringement of patents or other rights of third parties which may result from its use. No license is granted by implication or otherwise under any patent or patent rights of STMicroelectronics. Specification mentioned in this publication are subject to change without notice. This publication supersedes and replaces all information previously supplied. STMicroelectronics products are not authorized for use as critical components in life support devices or systems without express written approval of STMicroelectronics.

The ST logo is a trademark of STMicroelectronics

© 2002 STMicroelectronics – Printed in Italy – All Rights Reserved

STMicroelectronics GROUP OF COMPANIES

Australia - Brazil - Canada - China - Finland - France - Germany - Hong Kong - India - Israel - Italy - Japan - Malaysia - Malta - Morocco - Singapore - Spain - Sweden - Switzerland - United Kingdom - United States.

<http://www.st.com>