

TURBO 2 ULTRAFAST HIGH VOLTAGE RECTIFIER
Table 1: Main Product Characteristics

$I_{F(AV)}$	8 A
V_{RRM}	600 V
I_R (max)	200 μA
T_j	175°C
V_F (typ)	0.85 V
t_{rr} (typ)	75 ns

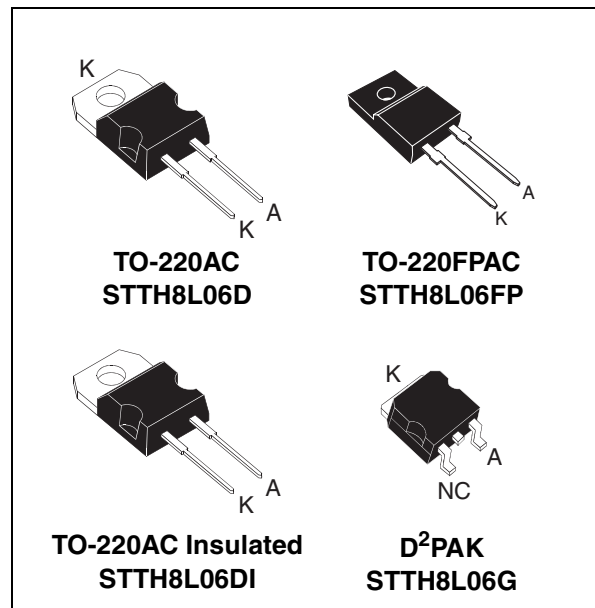
FEATURES AND BENEFITS

- Ultrafast switching
- Low reverse recovery current
- Low thermal resistance
- Reduces switching and conduction losses

DESCRIPTION

The STTH8L06, which is using ST Turbo2 600V technology, is specially suited as boost diode in discontinuous or critical mode power factor corrections.

The device is also intended for use as a free wheeling diode in power supplies and other power switching applications.


Table 2: Order Codes

Part Number	Marking
STTH8L06D	STTH8L06D
STTH8L06FP	STTH8L06FP
STTH8L06DI	STTH8L06DI
STTH8L06DIRG	STTH8L06DI
STTH8L06G	STTH8L06G
STTH8L06G-TR	STTH8L06G

Table 3: Absolute Ratings (limiting values)

Symbol	Parameter		Value	Unit
V_{RRM}	Repetitive peak reverse voltage		600	V
$I_{F(RMS)}$	RMS forward voltage	TO-220AC / TO-220FPAC	30	A
		TO-220AC Ins.	24	
$I_{F(AV)}$	Average forward current $\delta = 0.5$	TO-220AC	8	A
		TO-220FPAC		
		TO-220AC Ins.		
I_{FSM}	Surge non repetitive forward current	$t_p = 10ms$ sinusoidal	120	A
T_{stg}	Storage temperature range		-65 to + 175	°C
T_j	Maximum operating junction temperature		175	°C

Table 4: Thermal Resistance

Symbol	Parameter		Value (max.)	Unit
$R_{th(j-c)}$	Junction to case	TO-220AC / D ² PAK	2.5	°C/W
		TO-220FPAC	5	
		TO-220AC Ins.	4	

Table 5: Static Electrical Characteristics

Symbol	Parameter	Test conditions		Min.	Typ	Max.	Unit
I_R	Reverse leakage current	$T_j = 25^\circ\text{C}$	$V_R = V_{RRM}$			8	μA
		$T_j = 150^\circ\text{C}$			16	200	
V_F	Forward voltage drop	$T_j = 25^\circ\text{C}$	$I_F = 8\text{A}$			1.3	V
		$T_j = 150^\circ\text{C}$			0.85	1.05	

To evaluate the conduction losses use the following equation: $P = 0.89 \times I_{F(AV)} + 0.022 I_F^2 (RMS)$

Table 6: Dynamic Characteristics

Symbol	Parameter	Test conditions		Min.	Typ	Max.	Unit
t_{rr}	Reverse recovery time	$T_j = 25^\circ\text{C}$	$I_F = 1\text{A}$ $di_F/dt = 50\text{ A}/\mu\text{s}$ $V_R = 30\text{V}$		75	105	ns
t_{fr}	Forward recovery time	$T_j = 25^\circ\text{C}$	$I_F = 8\text{A}$ $di_F/dt = 100\text{ A}/\mu\text{s}$ $V_{FR} = 1.1 \times V_{Fmax}$			150	ns
V_{FP}	Forward recovery voltage				$I_F = 8\text{A}$ $di_F/dt = 100\text{ A}/\mu\text{s}$		6

Figure 1: Conduction losses versus average current

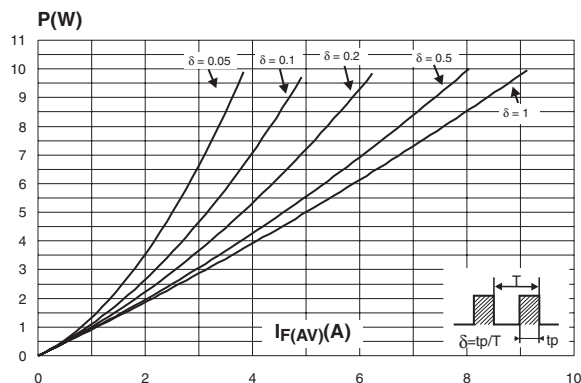


Figure 2: Forward voltage drop versus forward current

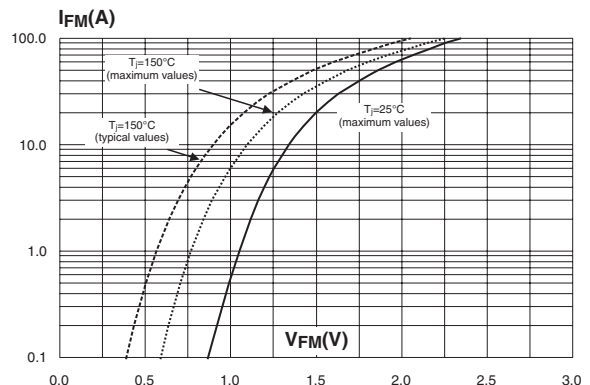


Figure 3: Relative variation of thermal impedance junction to case versus pulse duration (TO-220FPAC)

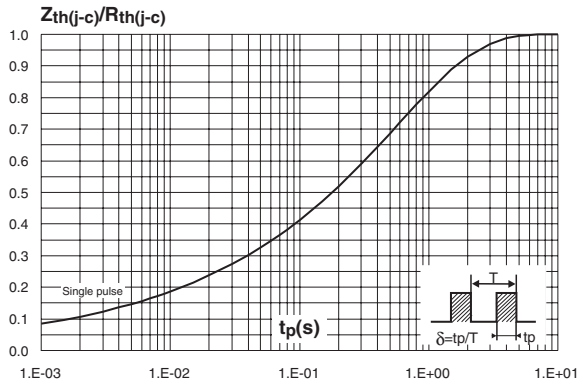


Figure 4: Relative variation of thermal impedance junction to case versus pulse duration (TO-220AC, TO-220AC Ins., D²PAK)

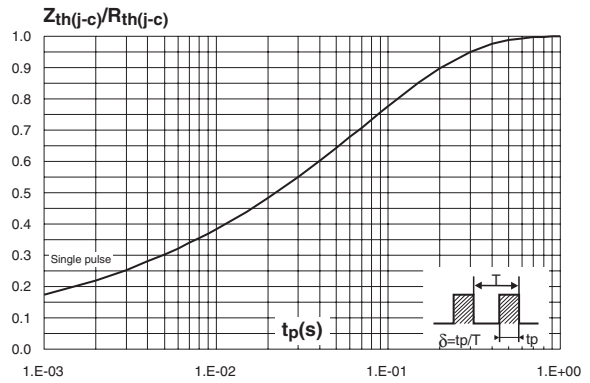


Figure 5: Peak reverse recovery current versus di_F/dt (typical values)

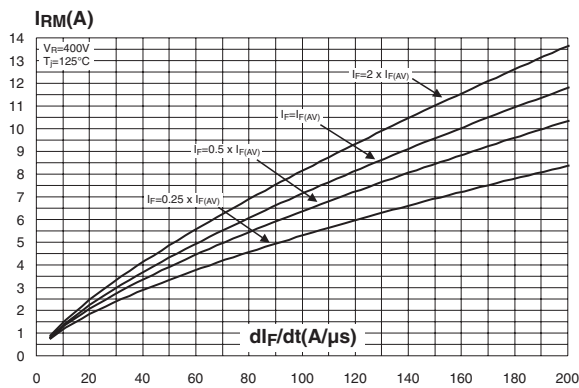


Figure 6: Reverse recovery time versus di_F/dt (typical values)

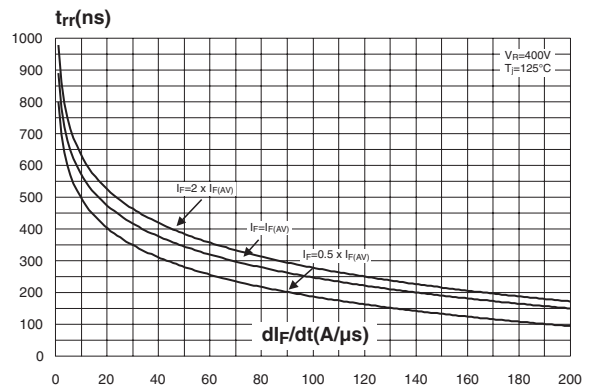


Figure 7: Reverse recovery charges versus di_F/dt (typical values)

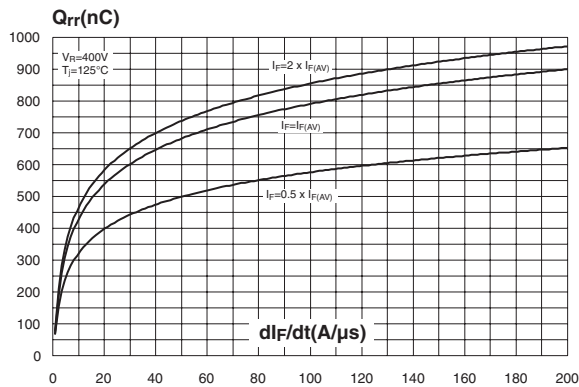


Figure 8: Softness factor versus di_F/dt (typical values)

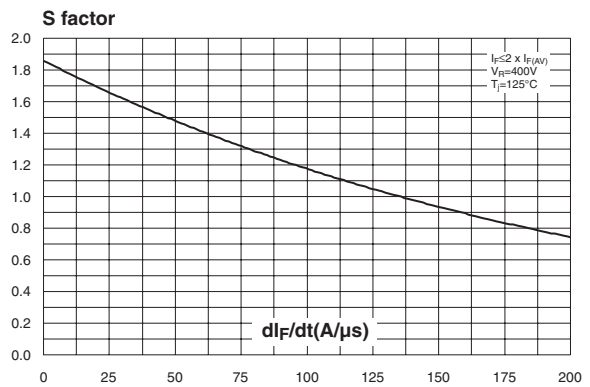


Figure 9: Relative variations of dynamic parameters versus junction temperature

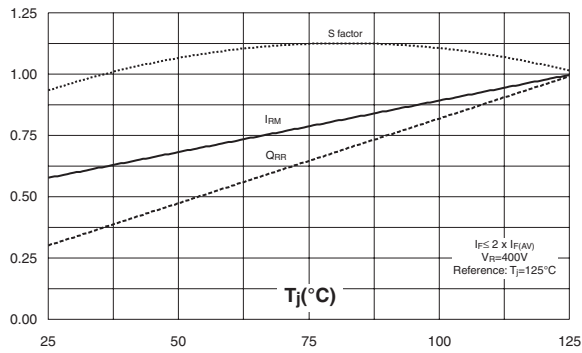


Figure 10: Transient peak forward voltage versus di_F/dt

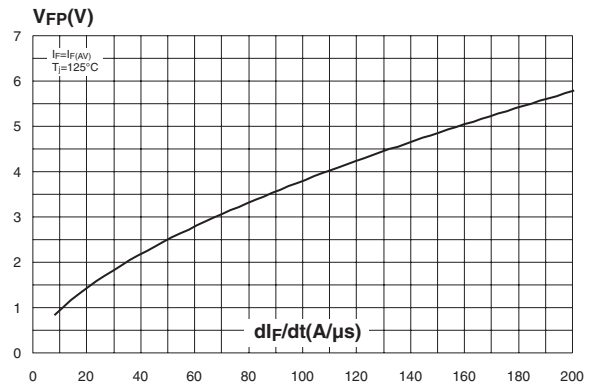


Figure 11: Forward recovery time versus di_F/dt (typical values)

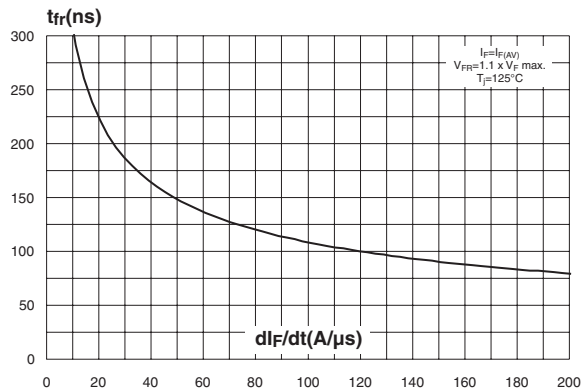


Figure 12: Junction capacitance versus reverse voltage applied (typical values)

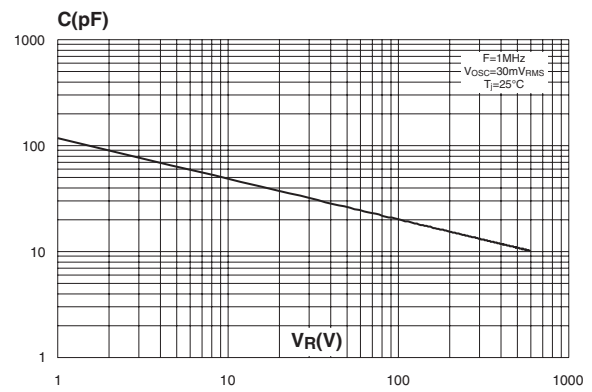


Figure 13: Thermal resistance junction to ambient versus copper surface under tab (epoxy FR4, $e_{Cu} = 35\mu m$) (D²PAK)

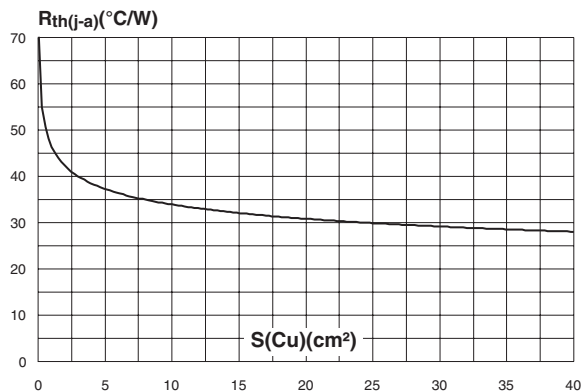


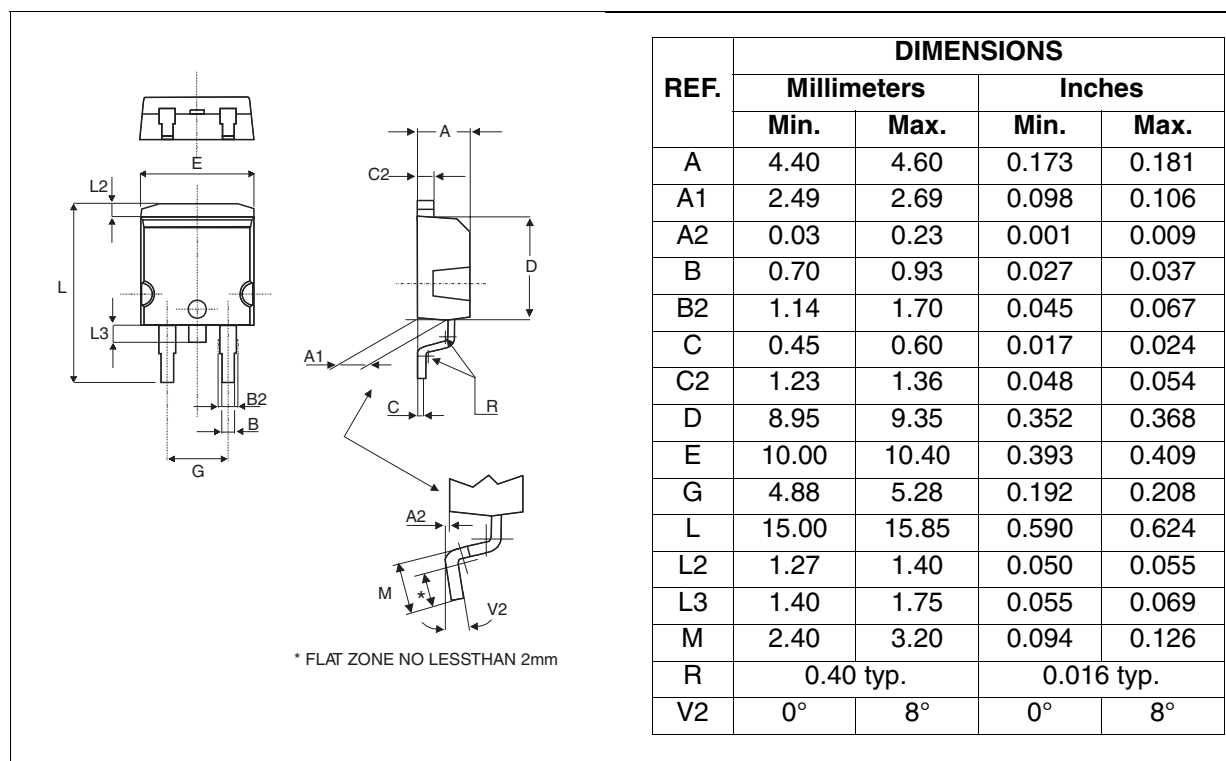
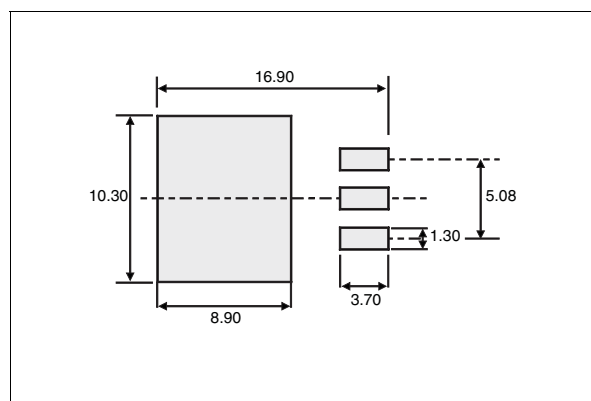
Figure 14: D²PAK Package Mechanical DataFigure 15: D²PAK Foot Print Dimensions
(in millimeters)

Figure 16: TO-220FPAC Package Mechanical Data

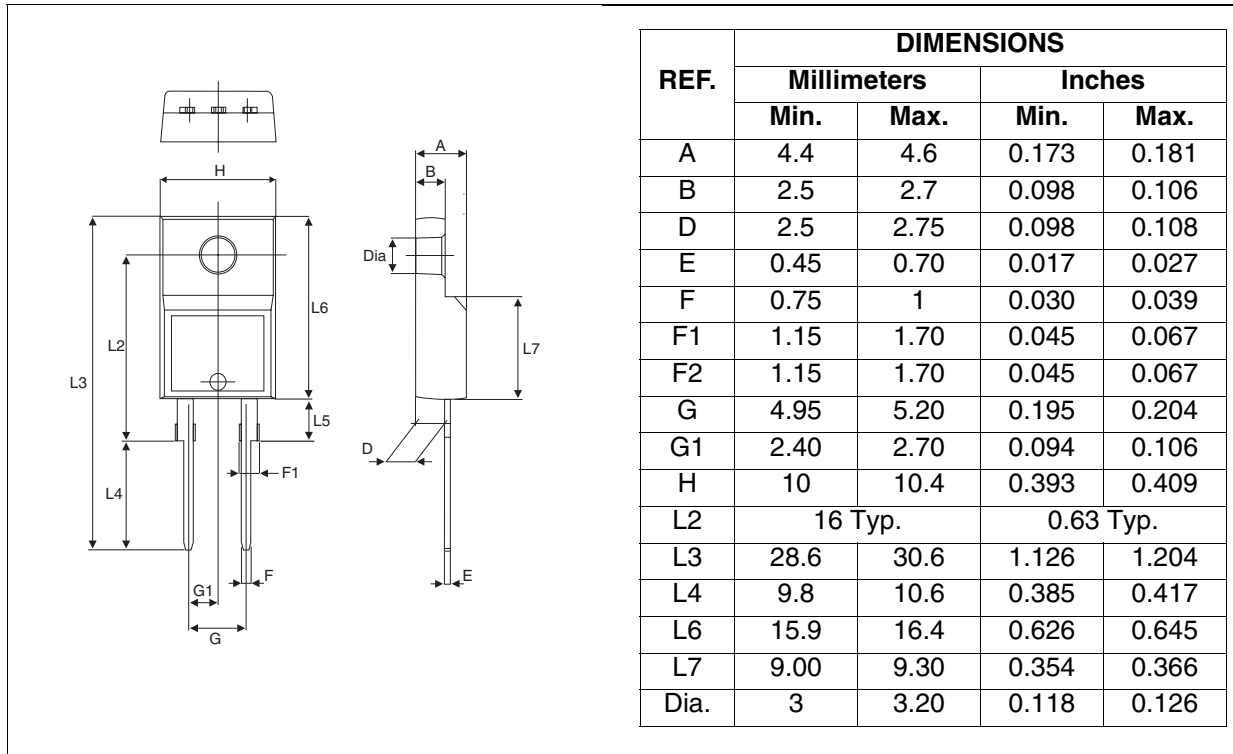


Figure 17: TO-220AC Insulated Package Mechanical Data

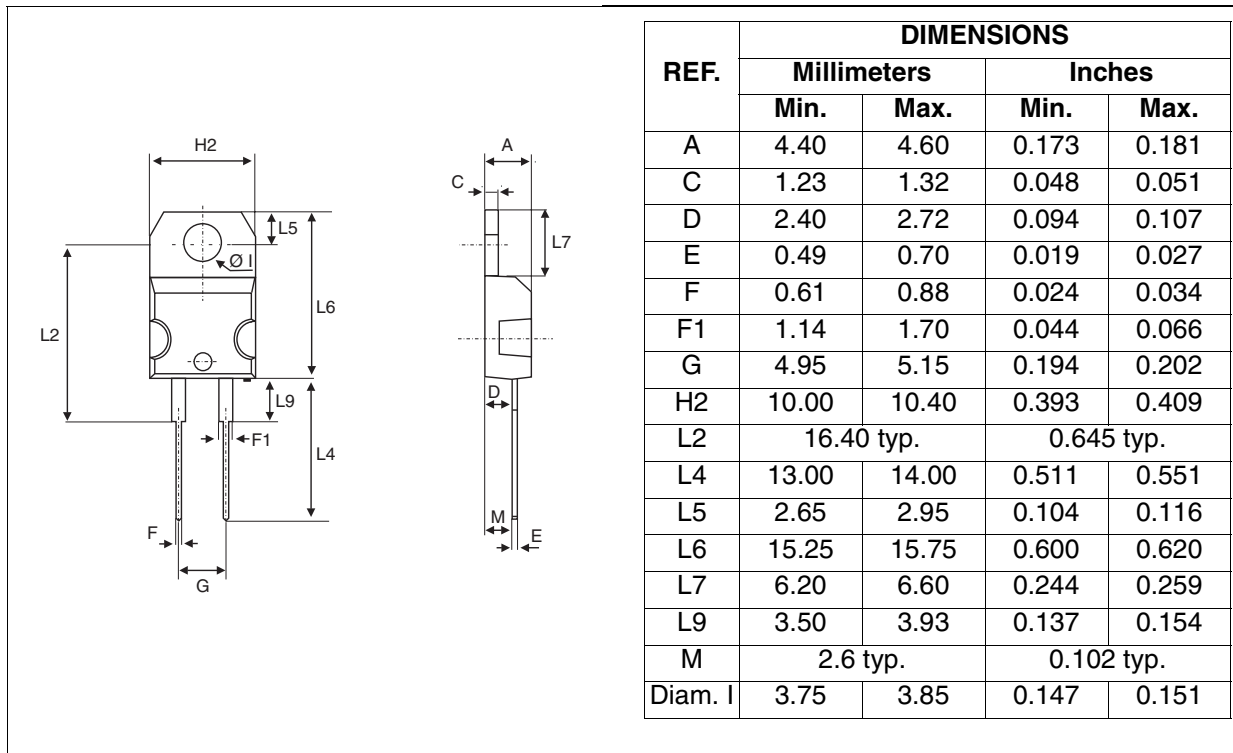


Figure 18: TO-220AC Package Mechanical Data

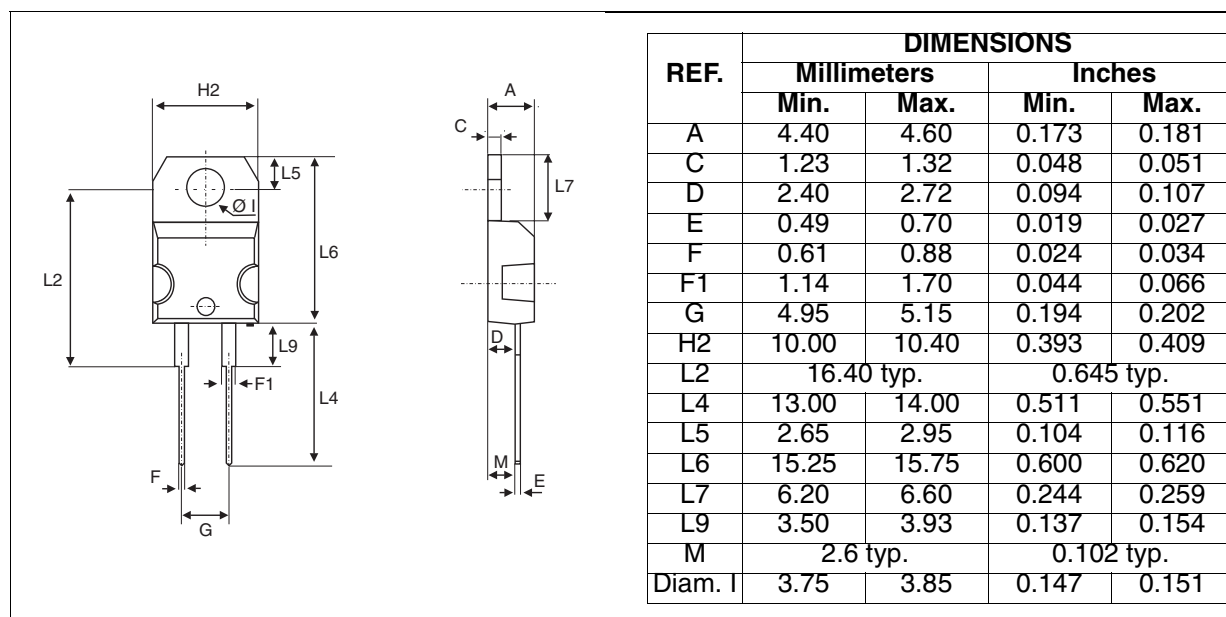


Table 7: Ordering Information

Ordering type	Marking	Package	Weight	Base qty	Delivery mode
STTH8L06D	STTH8L06D	TO-220AC	1.90 g	50	Tube
STTH8L06FP	STTH8L06FP	TO-220FPAC	1.70 g	50	Tube
STTH8L06DI	STTH8L06DI	TO-220AC Ins.	1.86 g	250	Box
STTH8L06DIRG	STTH8L06DI	TO-220AC Ins	1.86 g	50	Tube
STTH8L06G	STTH8L06G	D ² PAK	1.48 g	50	Tube
STTH8L06G-TR	STTH8L06G	D ² PAK	1.48 g	1000	Tape & reel

- Epoxy meets UL94, V0
- Cooling method: by conduction (C)
- Recommended torque value: 0.8 m.N. (TO-220FPAC) / 0.55 m.N. (TO-220AC)
- Maximum torque value: 1.0 m.N. (TO-220FPAC) / 0.70 m.N. (TO-220AC)

Table 8: Revision History

Date	Revision	Description of Changes
Nov-2002	2A	Last issue
18-Oct-2004	3	TO-220AC Insulated and D ² PAK packages added

Information furnished is believed to be accurate and reliable. However, STMicroelectronics assumes no responsibility for the consequences of use of such information nor for any infringement of patents or other rights of third parties which may result from its use. No license is granted by implication or otherwise under any patent or patent rights of STMicroelectronics. Specifications mentioned in this publication are subject to change without notice. This publication supersedes and replaces all information previously supplied. STMicroelectronics products are not authorized for use as critical components in life support devices or systems without express written approval of STMicroelectronics.

The ST logo is a registered trademark of STMicroelectronics.
All other names are the property of their respective owners

© 2004 STMicroelectronics - All rights reserved

STMicroelectronics group of companies

Australia - Belgium - Brazil - Canada - China - Czech Republic - Finland - France - Germany - Hong Kong - India - Israel - Italy - Japan -
Malaysia - Malta - Morocco - Singapore - Spain - Sweden - Switzerland - United Kingdom - United States of America

www.st.com