

1N4148W, 1N4148WS

SMALL SIGNAL DIODES

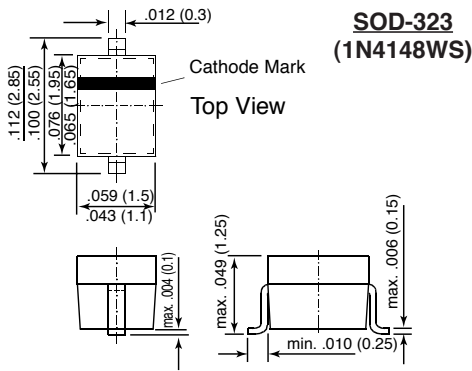
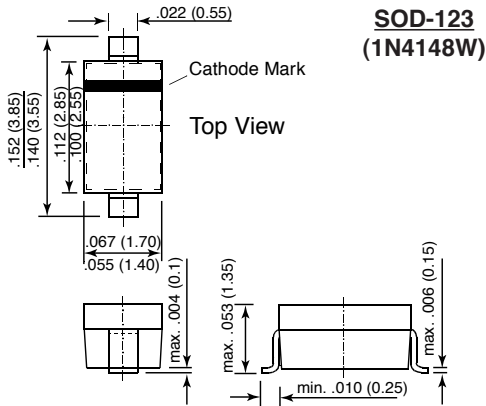

Dimensions in inches and (millimeters)

FEATURES

- ◆ Silicon Epitaxial Planar Diode
- ◆ Fast switching diodes.
- ◆ This diode is also available in other case styles including: the DO-35 case with the type designation 1N4148, the Mini-MELF case with the type designation LL4148, and the SOT-23 case with the type designation IMBD4148.



MECHANICAL DATA

1N4148W

Case: SOD-123 Plastic Case

Weight: approx. 0.01 g

Marking Code: A2

1N4148WS

Case: SOD-323 Plastic Case

Weight: approx. 0.004 g

Marking Code: A2

MAXIMUM RATINGS

Ratings at 25°C ambient temperature unless otherwise specified.

	SYMBOL	VALUE	UNIT
Reverse Voltage	V _R	75	Volts
Peak Reverse Voltage	V _{RM}	100	Volts
Rectified Current (Average) Half Wave Rectification with Resist. Load at T _{amb} = 25 °C and f ≥ 50 Hz	I _o	150 ⁽¹⁾	mA
Surge Forward Current at t < 1 s and T _j = 25 °C	I _{FSM}	500 350	mA mA
Power Dissipation at T _{amb} = 25 °C	P _{tot}	400 ⁽¹⁾ 200 ⁽¹⁾	mW mW
Junction Temperature	T _j	150	°C
Storage Temperature Range	T _s	- 65 to +150	°C

NOTES:

(1) Valid provided that electrodes are kept at ambient temperature

1N4148W, 1N4148WS

ELECTRICAL CHARACTERISTICS

Ratings at 25 °C ambient temperature unless otherwise specified

	SYMBOL	MIN.	TYP.	MAX.	UNIT
Forward Voltage at $I_F=10$ mA	V_F	–	–	1.0	Volts
Leakage Current at $V_R = 20$ V at $V_R = 75$ V at $V_R = 20$ V, $T_j = 150$ °C	I_R	–	–	25	nA
	I_R	–	–	5.0	μ A
	I_R	–	–	50	μ A
Capacitance at $V_F = V_R = 0$ V	C_{tot}	–	–	4	pF
Voltage Rise when Switching On tested with 50 mA Pulses $t_p = 0.1\mu$ s, Rise Time < 30ns, $f_p = 5$ to 100 kHz	V_{fr}	–	–	2.5	Volts
Reverse Recovery Time from $I_F = 10$ mA to $I_R = 1$ mA, $V_R = 6$ V, $R_L = 100$ Ω	t_{rr}	–	–	4	ns
Thermal Resistance Junction to Ambient Air 1N4148W 1N4148WS	R_{thJA}	–	–	450 ⁽²⁾	°C/W
	R_{thJA}	–	–	650 ⁽²⁾	°C/W
Rectification Efficiency at $f = 100$ MHz, $V_{RF} = 2$ V	η_v	0.45	–	–	–

NOTES::

(2) Valid provided that electrodes are kept at ambient temperature

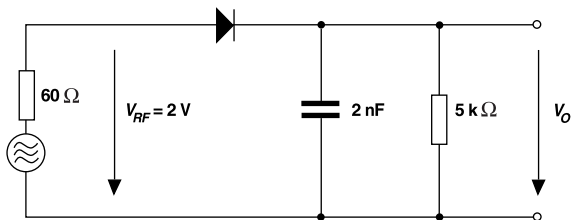

Rectification Efficiency Measurement Circuit

RATINGS AND CHARACTERISTICS CURVES 1N4148W, 1N4148WS

Forward characteristics

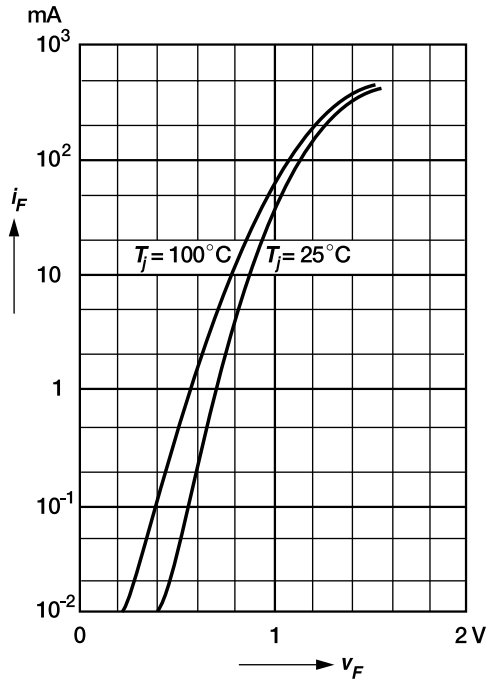

Dynamic forward resistance versus forward current

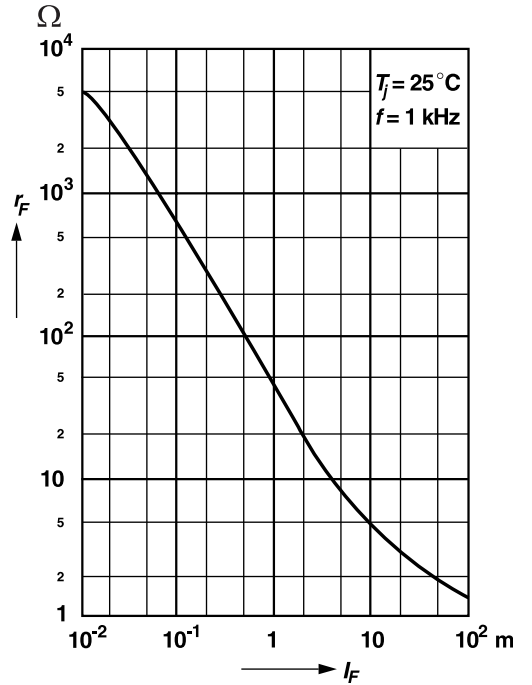

Admissible power dissipation versus ambient temperature

For conditions, see footnote in table "Absolute Maximum Ratings"

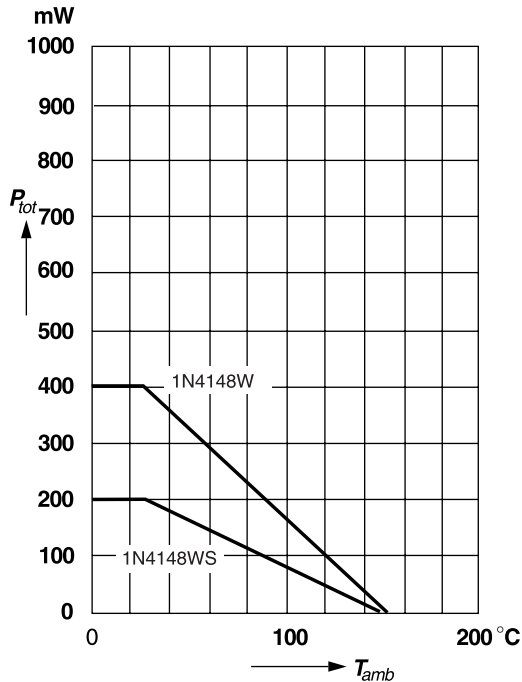

Relative capacitance versus reverse voltage

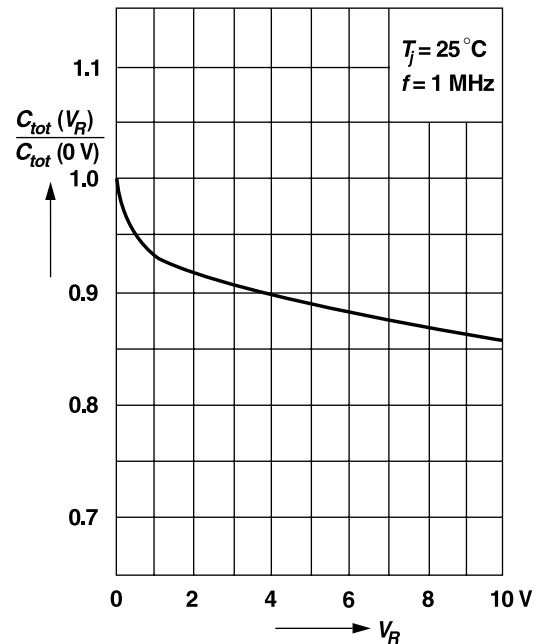

RATINGS AND CHARACTERISTICS CURVES 1N4148W, 1N4148WS

Leakage current versus junction temperature

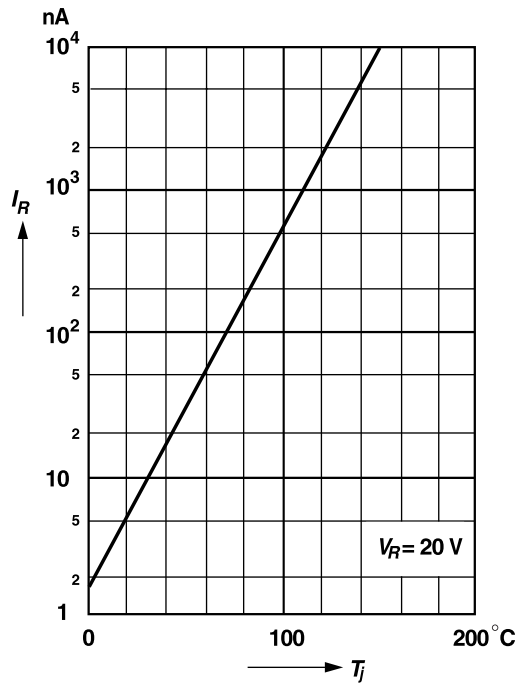

Admissible repetitive peak forward current versus pulse duration

For conditions, see footnote in table "Absolute Maximum Ratings"

