

Passivated Rectifier

TRANSIENT VOLTAGE PROTECTED
2.5 Amps 200-1000 Volts

1N4245
1N4246
1N4247
1N4248
1N4249

THE GENERAL ELECTRIC 1N4245-49 SERIES ARE A14 TYPES, 2.5 AMPERE RATED, AXIAL-LEADED, GENERAL PURPOSE RECTIFIERS. DUAL HEAT-SINK CONSTRUCTION PROVIDES RIGID MECHANICAL SUPPORT FOR THE PELLET AND EXCELLENT THERMAL CHARACTERISTICS. PASSIVATION AND PROTECTION OF THE SILICON PELLETS PN JUNCTION ARE PROVIDED BY SOLID GLASS; NO ORGANIC MATERIALS ARE PRESENT WITHIN THE HERMETICALLY-SEALED PACKAGE.

The 1N4245-49 series (A14's) are "Transient-Voltage Protected." These devices will dissipate up to 1000 watts in the reverse direction without damage. Voltage transients generated by household or industrial power lines are dissipated.

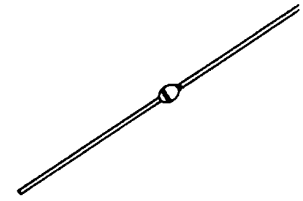

absolute maximum ratings: (25°C unless otherwise specified)

	1N4245	1N4246	1N4247	1N4248	1N4249	
*Reverse Voltage (-65 to +160°C, T _J)						
Working Peak, V _{RWM}	200	400	600	800	1000	Volts
DC, V _R	200	400	600	800	1000	Volts
*Average Forward Current, I _O						
55°C ambient (see rating curves)	←————— 1.0 —————→					Amp
25°C " " "	←————— 2.5 —————→					Amp
*Peak Surge Forward Current, I _{FSM}						
Non-repetitive, .0083 sec						
Half sine wave	←————— 25 —————→					Amps
Full load JEDEC method						
Peak Surge Forward Current, I _{FSM}						
Non-repetitive, .001 sec						
Half sine wave						
Full load 160°C, T _J	←————— 90 —————→					Amps
No Load (25°C Case)	←————— 100 —————→					Amps
*Junction Operating Temperature Range, T _J	←————— -65°C to +160°C —————→					
*Storage Temperature Range, T _{STG}	←————— -65°C to +200°C —————→					
I ² t, RMS for fusing, .001 to .01 sec.	←————— 4.0 —————→					Amps ² sec.
Peak Non-Repetitive Reverse Power Rating, P _{RM}	←————— 1000 —————→					Watts
(20 μsec. half sine wave, at Max. T _J)						
Mounting: Any position. Lead temperature 290°C maximum to 1/8" from body for 5 seconds maximum during mounting.						

electrical characteristics: (25°C unless otherwise specified)

* Maximum Forward Voltage Drop, V _{FM}	←————— 1.2 —————→	Volts
I _F = 1.0A, T _A = +55°C		
* Maximum Reverse Current, I _{RM}		
at rated V _R		
T _J = +25°C	←————— 1.0 —————→	μA
T _J = +125°C	←————— 25 —————→	μA
Typical Reverse Recovery Time, t _{rr}	←————— 2.5 —————→	μsec
Maximum Reverse Recovery Time, t _{rr}	←————— 5.0 —————→	μsec
(Recovery Circuit Per MIL-S-19500/286B)		
*JEDEC Registered data.		

1N4245-1

MAXIMUM ALLOWABLE DC OUTPUT CURRENT RATINGS

SINGLE PHASE
600 VOLTS & BELOW

1N4245
1N4246
1N4247
1N4248
1N4249

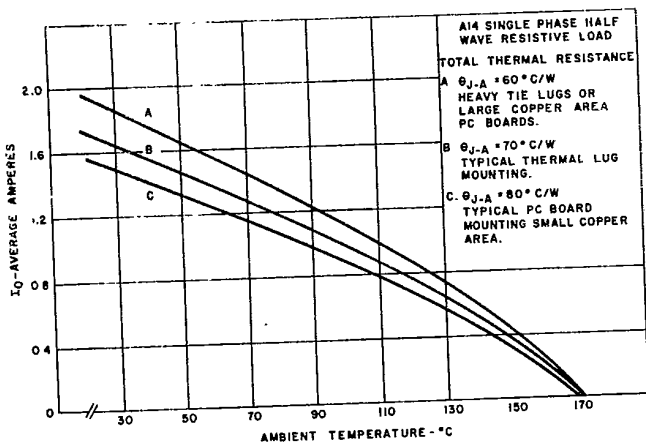

AMBIENT OPERATION
(See Typical Mounting Below)

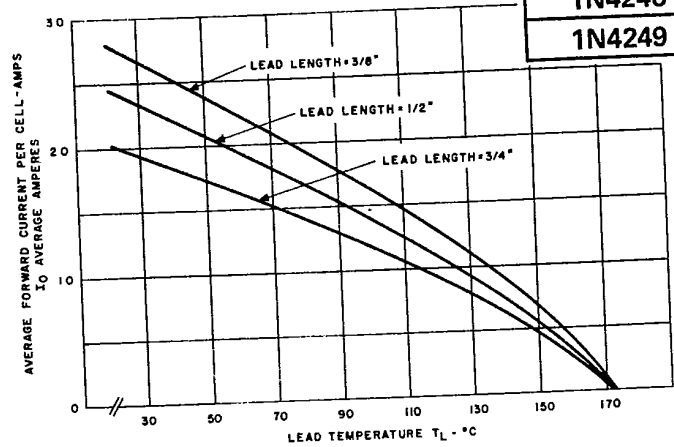

TIE POINT OPERATION

TYPICAL CHARACTERISTICS

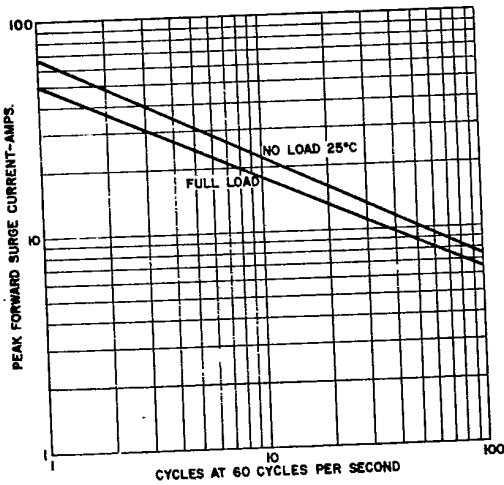

MAXIMUM NON-REPETITIVE MULTICYCLE FORWARD SURGE CURRENT

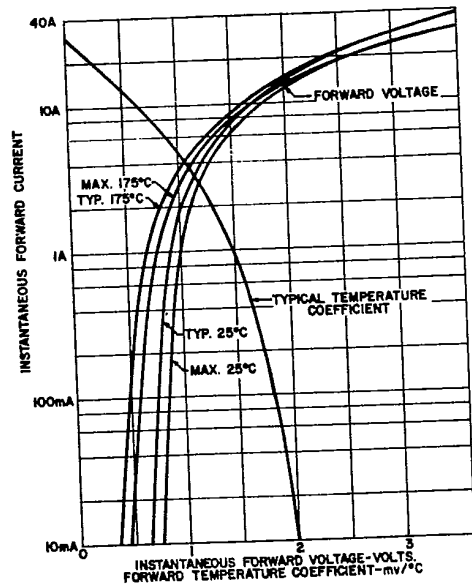

FORWARD CHARACTERISTICS

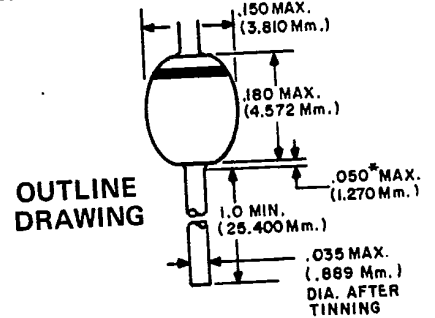
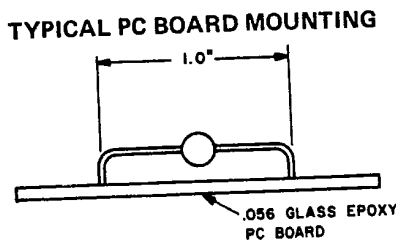
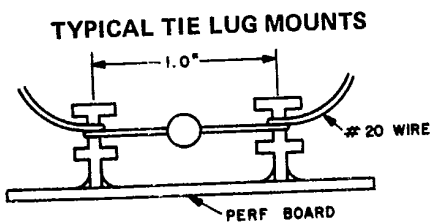

ALL DIMENSIONS ARE IN INCHES AND (METRIC)
*WELD AND SOLDER FLASH NOT CONTROLLED IN THIS AREA

1N4245-2
271