



N-Channel Enhancement Mode Field Effect Transistor

PRODUCT SUMMARY		
V _{DSS}	I _D	R _{DS(ON)} (Ω) Max
60V	0.25A	3.0 @ V _{GS} = 10V
		4.0 @ V _{GS} = 5V

FEATURES

- Super high dense cell design for low R_{DS(ON)}.
- Rugged and reliable.
- SOT-23 package.



ABSOLUTE MAXIMUM RATINGS (T_A=25 °C unless otherwise)

Parameter	Symbol	Limit	Unit
Drain-Source Voltage	V _{DS}	60	V
Gate-Source Voltage	V _{GS}	±20	V
Drain Current-Continuous ^a @ T _J =125°C -Pulsed ^b	I _D	250	mA
	I _{DM}	1.0	A
Drain-Source Diode Forward Current ^a	I _S	250	mA
Maximum Power Dissipation ^a	P _D	200	mW
Operating Junction and Storage Temperature Range	T _J , T _{STG}	-55 to 150	°C

THERMAL CHARACTERISTICS

Thermal Resistance, Junction-to-Ambient ^a	R _{thJA}	625	°C/W
--	-------------------	-----	------

2N7002E

ELECTRICAL CHARACTERISTICS (TA=25 °C unless otherwise noted)

Parameter	Symbol	Condition	Min	Typ ^c	Max	Unit
OFF CHARACTERISTICS						
Drain-Source Breakdown Voltage	BV _{DSS}	V _{GS} = 0V, I _D = 10uA	60			V
Zero Gate Voltage Drain Current	I _{DSS}	V _{DS} = 60V, V _{GS} = 0V			1	uA
Gate-Body Leakage	I _{GSS}	V _{GS} = ±20V, V _{DS} = 0V			±100	nA
ON CHARACTERISTICS^b						
Gate Threshold Voltage	V _{GS(th)}	V _{DS} = V _{GS} , I _D = 250uA	1	2.0	2.5	V
Drain-Source On-State Resistance	R _{DS(ON)}	V _{GS} = 10V, I _D = 250mA			3.0	ohm
		V _{GS} = 5V, I _D = 50mA			4.0	ohm
On-State Drain Current	I _{D(ON)}	V _{DS} = 7V, V _{GS} = 10V	500			mA
Forward Transconductance	g _{FS}	V _{DS} = 7V, I _D = 200mA	80			mS
DYNAMIC CHARACTERISTICS^c						
Input Capacitance	C _{ISS}	V _{DS} = 25V, V _{GS} = 0V f = 1.0MHz		19	50	pF
Output Capacitance	C _{OSS}			10	25	pF
Reverse Transfer Capacitance	C _{RSS}			3	5	pF
SWITCHING CHARACTERISTICS^c						
Turn-On Delay Time	t _{D(ON)}	V _{DD} = 30V, I _D = 100mA, V _{GS} = 10V, R _{GEN} = 10 ohm		7.5	20	ns
Rise Time	t _r			6		ns
Turn-Off Delay Time	t _{D(OFF)}			7.5	20	ns
Fall Time	t _f			3		ns

2N7002E

ELECTRICAL CHARACTERISTICS ($T_A=25^{\circ}\text{C}$ unless otherwise noted)

Parameter	Symbol	Condition	Min	Typ ^c	Max	Unit
DRAIN-SOURCE DIODE CHARACTERISTICS^b						
Diode Forward Voltage	V_{SD}	$V_{GS} = 0V, I_S = 115\text{mA}$		0.76	1.5	V

Notes

- a. Surface Mounted on FR4 Board, $t \leq 10\text{sec}$.
- b. Pulse Test: Pulse Width $\leq 300\ \mu\text{s}$, Duty Cycle $\leq 2\%$.
- c. Guaranteed by design, not subject to production testing.

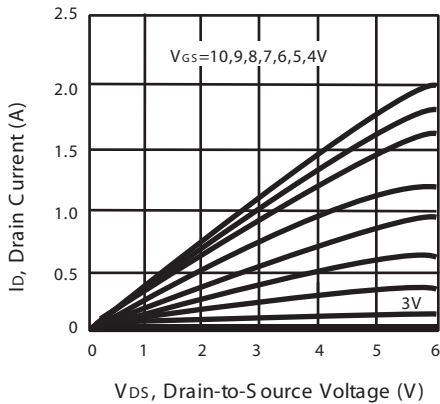

Figure 1. Output Characteristics

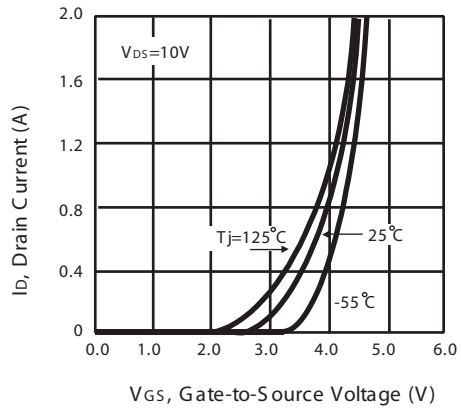

Figure 2. Transfer Characteristics

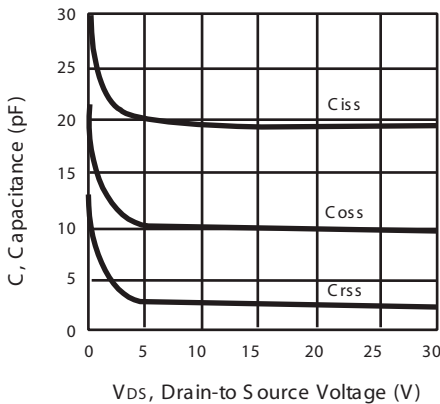

Figure 3. Capacitance

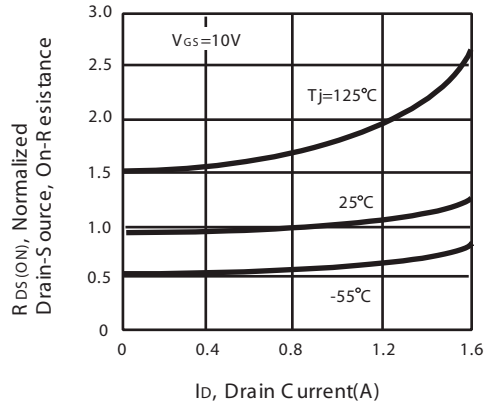

Figure 4. On-Resistance Variation with Drain Current and Temperature

2N7002E

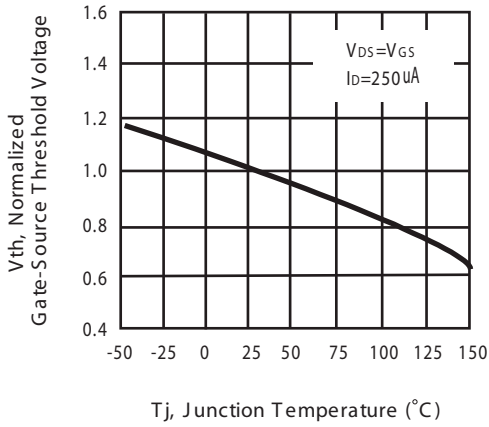

Figure 5. Gate Threshold Variation with Temperature

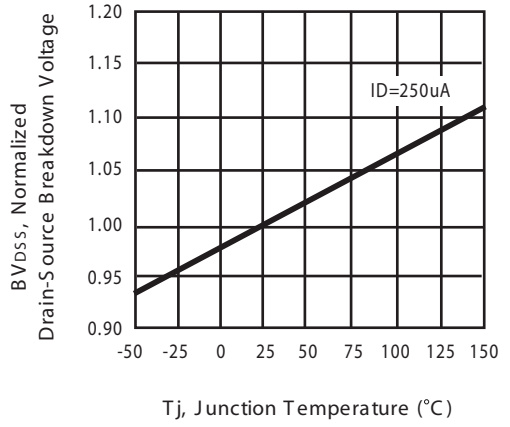

Figure 6. Breakdown Voltage Variation with Temperature

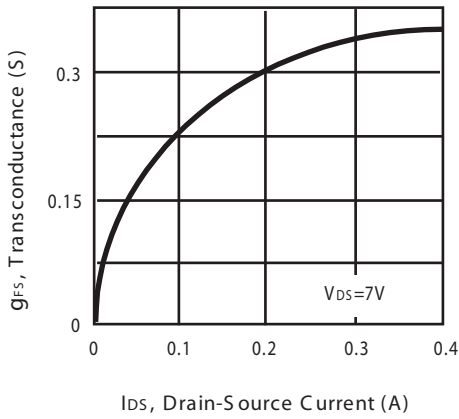

Figure 7. Transconductance Variation with Drain Current

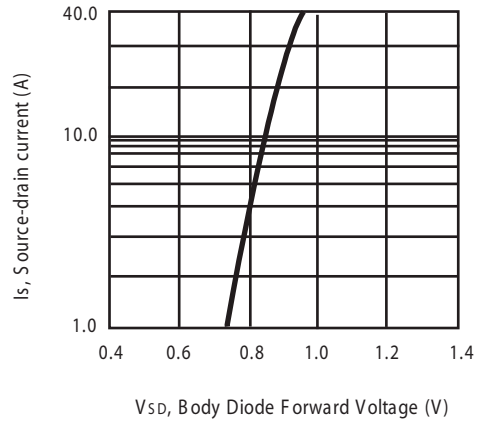

Figure 8. Body Diode Forward Voltage Variation with Source Current

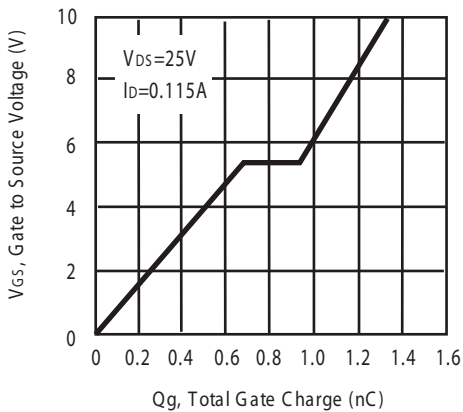

Figure 9. Gate Charge

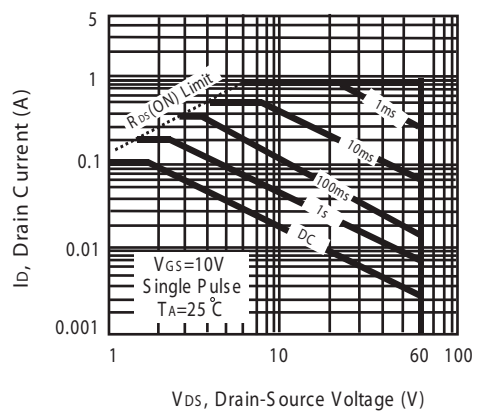

Figure 10. Maximum Safe Operating Area

2N7002E

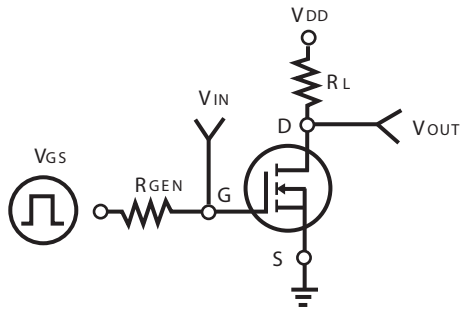

Figure 11. Switching Test Circuit

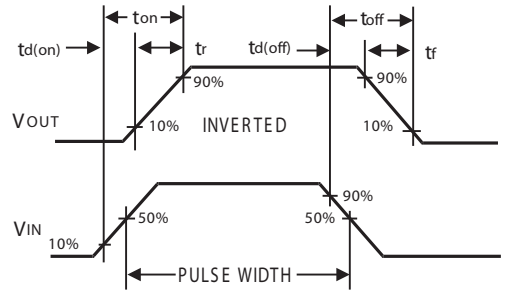

Figure 12. Switching Waveforms

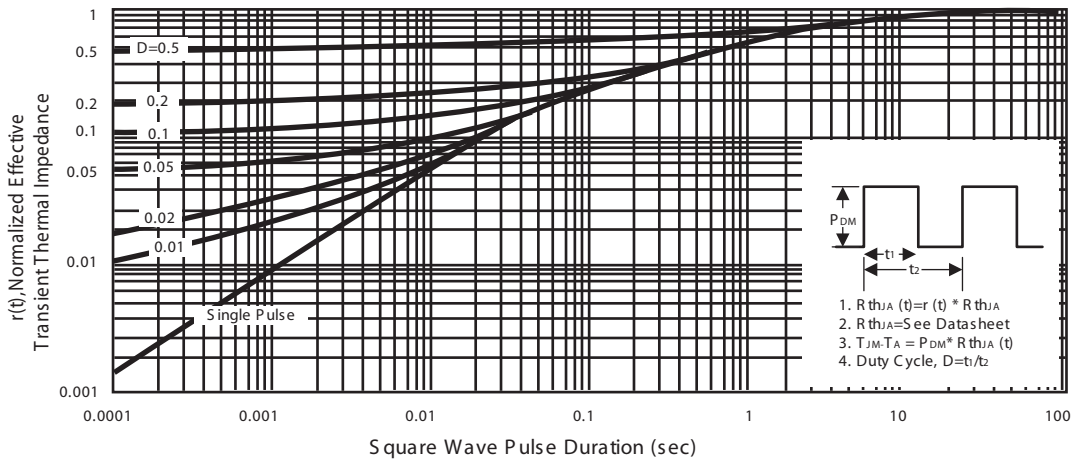

Figure 13. Normalized Thermal Transient Impedance Curve