



Improved Precision Micropower Shunt Voltage Reference with Multiple Reverse Breakdown Voltages

General Description

The LM4040 is a precision two-terminal shunt mode, bandgap voltage reference available in fixed reverse breakdown voltages of 2.048V, 2.500V, 3.000V, 3.3V, 4.096V, and 5.000V. Ideal for space-critical applications, the LM4040 is offered in the subminiature 3-pin SC70 surface-mount package (1.8mm × 1.8mm), 50% smaller than comparable devices in SOT23 surface-mount packages (SOT23 versions are also available).

Laser-trimmed resistors ensure precise initial accuracy. With a 100ppm/°C temperature coefficient, the device is offered in four grades of initial accuracy ranging from 0.1% to 1%. The LM4040 has a 60µA to 15mA shunt current capability with low dynamic impedance, ensuring stable reverse breakdown voltage accuracy over a wide range of operating temperatures and currents.

The LM4040 does not require an external stabilizing capacitor while ensuring stability with any capacitive load.

The LM4040 is guaranteed over the temperature range of -40°C to +125°C.

For a 1.225V output version, refer to the LM4041 data sheet.

Applications

Portable, Battery-Powered Equipment
 Notebook Computers
 Cell Phones
 Industrial Process Controls

Pin Configuration

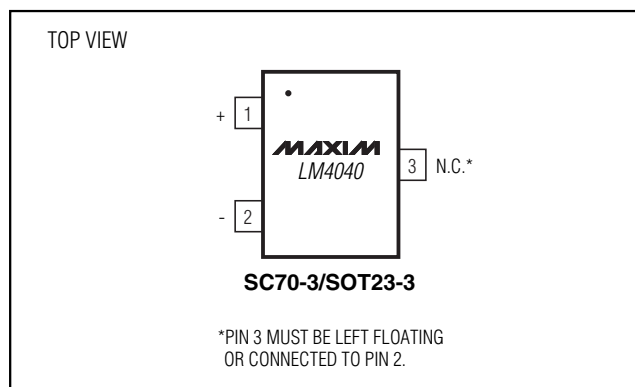

Features

- ◆ Ultra-Small 3-Pin SC70 Package
- ◆ 0.1% (max) Initial Accuracy
- ◆ 100ppm/°C (max) Temperature Coefficient
Guaranteed over -40°C to +125°C Temperature Range
- ◆ Wide Operating Current Range: 60µA to 15mA
- ◆ Low 28µVRMS Output Noise (10Hz to 10kHz)
- ◆ 2.048V, 2.500V, 3.000V, 3.3V, 4.096V, and 5.000V Fixed Reverse Breakdown Voltages
- ◆ No Output Capacitors Required
- ◆ Tolerates Capacitive Loads

Selector Guide

PART	TEMP RANGE	PIN-PACKAGE	OUTPUT VOLTAGE (V)
LM4040_IM3-2.1	-40°C to +85°C	3 SOT23-3	2.048
LM4040_IX3-2.1	-40°C to +85°C	3 SC70-3	2.048
LM4040_EM3-2.1	-40°C to +125°C	3 SOT23-3	2.048
LM4040_EX3-2.1	-40°C to +125°C	3 SC70-3	2.048
LM4040_IM3-2.5	-40°C to +85°C	3 SOT23-3	2.500
LM4040_IX3-2.5	-40°C to +85°C	3 SC70-3	2.500
LM4040_EM3-2.5	-40°C to +125°C	3 SOT23-3	2.500
LM4040_EX3-2.5	-40°C to +125°C	3 SC70-3	2.500
LM4040_IM3-3.0	-40°C to +85°C	3 SOT23-3	3.000
LM4040_IX3-3.0	-40°C to +85°C	3 SC70-3	3.000
LM4040_EM3-3.0	-40°C to +125°C	3 SOT23-3	3.000
LM4040_EX3-3.0	-40°C to +125°C	3 SC70-3	3.000
LM4040_EX3-3.3	-40°C to +125°C	3 SC70-3	3.300
LM4040_IM3-4.1	-40°C to +85°C	3 SOT23-3	4.096
LM4040_IX3-4.1	-40°C to +85°C	3 SC70-3	4.096
LM4040_EM3-4.1	-40°C to +125°C	3 SOT23-3	4.096
LM4040_EX3-4.1	-40°C to +125°C	3 SC70-3	4.096
LM4040_IM3-5.0	-40°C to +85°C	3 SOT23-3	5.000
LM4040_IX3-5.0	-40°C to +85°C	3 SC70-3	5.000
LM4040_EM3-5.0	-40°C to +125°C	3 SOT23-3	5.000
LM4040_EX3-5.0	-40°C to +125°C	3 SC70-3	5.000

Ordering Information appears at end of data sheet.



Improved Precision Micropower Shunt Voltage Reference with Multiple Reverse Breakdown Voltages

ABSOLUTE MAXIMUM RATINGS

Reverse Current (cathode to anode)	20mA
Forward Current (anode to cathode)	10mA
ESD per Method 3015.7	
Human Body Model	2000V
Machine Model.....	200V
Continuous Power Dissipation (T _A = +70°C)	
3-Pin SC70 (derate 2.17mW/°C above +70°C).....	174mW
3-Pin SOT23 (derate 4.01mW/°C above +70°C).....	320mW

Operating Temperature Range	
LM4040_I_ _ _	-40°C to +85°C
LM4040_E_ _ _	-40°C to +125°C
Storage Temperature Range	-65°C to +150°C
Junction Temperature	+150°C
Lead Temperature (soldering, 10s).....	+300°C

Stresses beyond those listed under "Absolute Maximum Ratings" may cause permanent damage to the device. These are stress ratings only, and functional operation of the device at these or any other conditions beyond those indicated in the operational sections of the specifications is not implied. Exposure to absolute maximum rating conditions for extended periods may affect device reliability.

ELECTRICAL CHARACTERISTICS—2.048V

(I_R = 100μA, T_A = T_{MIN} to T_{MAX}, unless otherwise noted. Typical values are at T_A = +25°C.) (Note 1)

PARAMETER	SYMBOL	CONDITIONS		MIN	TYP	MAX	UNITS	
Reverse Breakdown Voltage	V _R	T _A = +25°C	LM4040A (0.1%)	2.046	2.048	2.050	V	
			LM4040B (0.2%)	2.044	2.048	2.052		
			LM4040C (0.5%)	2.038	2.048	2.058		
			LM4040D (1.0%)	2.028	2.048	2.068		
Reverse Breakdown Voltage Tolerance (Note 2)	V _R	LM4040A		±2.0		±15	mV	
		LM4040B		±4.0		±17		
		LM4040C		±10		±23		
		LM4040D		±20		±41		
Minimum Operating Current	I _{RMIN}	LM4040A/B/C		45		65	μA	
		LM4040D		45		70		
Average Reverse Voltage Temperature Coefficient (Note 2)	ΔV _R /ΔT	I _R = 10mA			±20		ppm/°C	
		I _R = 1mA	LM4040A/B/C		±15			±100
			LM4040D		±15			±150
Reverse Breakdown Voltage Change with Operating Current Change		I _{RMIN} ≤ I _R ≤ 1mA	LM4040A/B/C		0.3		1.0	mV
			LM4040D		0.3		1.2	
		1mA ≤ I _R ≤ 15mA	LM4040A/B/C		2.5		8.0	
			LM4040D		2.5		10.0	
Reverse Dynamic Impedance (Note 3)	Z _R	I _R = 1mA, f = 120Hz, I _{AC} = 0.1I _R	LM4040A/B		0.3		0.8	Ω
			LM4040C		0.3		0.9	
			LM4040D		0.3		1.1	
Wideband Noise	e _N	I _R = 100μA, 10Hz ≤ f ≤ 10kHz		28			μV _{RMS}	
Reverse Breakdown Voltage Long-Term Stability	ΔV _R	T = 1000h		120			ppm	

Improved Precision Micropower Shunt Voltage Reference with Multiple Reverse Breakdown Voltages

LM4040

ELECTRICAL CHARACTERISTICS—2.500V

($I_R = 100\mu\text{A}$, $T_A = T_{\text{MIN}}$ to T_{MAX} , unless otherwise noted. Typical values are at $T_A = +25^\circ\text{C}$.) (Note 1)

PARAMETER	SYMBOL	CONDITIONS	MIN	TYP	MAX	UNITS	
Reverse Breakdown Voltage	V_R	$T_A = +25^\circ\text{C}$	LM4040A (0.1%)	2.4975	2.5000	2.5025	V
			LM4040B (0.2%)	2.4950	2.5000	2.5050	
			LM4040C (0.5%)	2.4875	2.5000	2.5125	
			LM4040D (1.0%)	2.4750	2.5000	2.5250	
Reverse Breakdown Voltage Tolerance (Note 2)	V_R	LM4040A		± 2.0	± 19	mV	
		LM4040B		± 4.0	± 21		
		LM4040C		± 10	± 29		
		LM4040D		± 20	± 49		
Minimum Operating Current	$I_{R\text{MIN}}$	LM4040A/B/C		45	65	μA	
		LM4040D		45	70		
Average Reverse Voltage Temperature Coefficient (Note 2)	$\Delta V_R/\Delta T$	$I_R = 10\text{mA}$		± 20		ppm/ $^\circ\text{C}$	
		$I_R = 1\text{mA}$	LM4040A/B/C		± 15		± 100
			LM4040D		± 15		± 150
Reverse Breakdown Voltage Change with Operating Current Change		$I_{R\text{MIN}} \leq I_R \leq 1\text{mA}$	LM4040A/B/C		0.3	1.0	mV
			LM4040D		0.4	1.2	
		$1\text{mA} \leq I_R \leq 15\text{mA}$	LM4040A/B/C		2.5	8.0	
			LM4040D		2.5	10.0	
Reverse Dynamic Impedance (Note 3)	Z_R	$I_R = 1\text{mA}$, $f = 120\text{Hz}$, $I_{AC} = 0.1I_R$	LM4040A/B		0.3	0.8	Ω
			LM4040C		0.3	0.9	
			LM4040D		0.3	1.1	
Wideband Noise	e_N	$I_R = 100\mu\text{A}$, $10\text{Hz} \leq f \leq 10\text{kHz}$		35		μVRMS	
Reverse Breakdown Voltage Long-Term Stability	ΔV_R	$T = 1000\text{h}$		120		ppm	

Improved Precision Micropower Shunt Voltage Reference with Multiple Reverse Breakdown Voltages

ELECTRICAL CHARACTERISTICS—3.000V

($I_R = 100\mu\text{A}$, $T_A = T_{\text{MIN}}$ to T_{MAX} , unless otherwise noted. Typical values are at $T_A = +25^\circ\text{C}$.) (Note 1)

PARAMETER	SYMBOL	CONDITIONS		MIN	TYP	MAX	UNITS
Reverse Breakdown Voltage	V_R	$T_A = +25^\circ\text{C}$	LM4040A (0.1%)	2.997	3.000	3.003	V
			LM4040B (0.2%)	2.994	3.000	3.006	
			LM4040C (0.5%)	2.985	3.000	3.015	
			LM4040D (1.0%)	2.970	3.000	3.030	
Reverse Breakdown Voltage Tolerance (Note 2)	V_R	LM4040A		± 3.0	± 22	mV	
		LM4040B		± 6.0	± 26		
		LM4040C		± 15	± 34		
		LM4040D		± 30	± 59		
Minimum Operating Current	$I_{R\text{MIN}}$	LM4040A/B/C		45	67	μA	
		LM4040D		45	70		
Average Reverse Voltage Temperature Coefficient (Note 2)	$\Delta V_R/\Delta T$	$I_R = 10\text{mA}$		± 20		ppm/ $^\circ\text{C}$	
		$I_R = 1\text{mA}$	LM4040A/B/C	± 15	± 100		
			LM4040D	± 15	± 150		
Reverse Breakdown Voltage Change with Operating Current Change		$I_{R\text{MIN}} \leq I_R \leq 1\text{mA}$	LM4040A/B/C	0.3	1.0	mV	
			LM4040D	0.3	1.2		
		$1\text{mA} \leq I_R \leq 15\text{mA}$	LM4040A/B/C	2.5	8.0		
			LM4040D	2.5	10.0		
Reverse Dynamic Impedance (Note 3)	Z_R	$I_R = 1\text{mA}$, $f = 120\text{Hz}$, $I_{AC} = 0.1I_R$	LM4040A/B	0.3	0.8	Ω	
			LM4040C	0.3	0.9		
			LM4040D	0.3	1.1		
Wideband Noise	e_N	$I_R = 100\mu\text{A}$, $10\text{Hz} \leq f \leq 10\text{kHz}$		45		μV_{RMS}	
Reverse Breakdown Voltage Long-Term Stability	ΔV_R	$T = 1000\text{h}$		120		ppm	

Improved Precision Micropower Shunt Voltage Reference with Multiple Reverse Breakdown Voltages

LM4040

ELECTRICAL CHARACTERISTICS—3.300V

($I_R = 100\mu\text{A}$, $T_A = T_{\text{MIN}}$ to T_{MAX} , unless otherwise noted. Typical values are at $T_A = +25^\circ\text{C}$.) (Note 1)

PARAMETER	SYMBOL	CONDITIONS		MIN	TYP	MAX	UNITS
Reverse Breakdown Voltage	V_R	$T_A = +25^\circ\text{C}$	LM4040A (0.1%)	3.2967	3.3000	3.3033	V
			LM4040B (0.2%)	3.2934	3.3000	3.3066	
			LM4040C (0.5%)	3.2835	3.3000	3.3165	
			LM4040D (1.0%)	3.2670	3.3000	3.3330	
Reverse Breakdown Voltage Tolerance (Note 2)	V_R	LM4040A		± 3.0	± 22	mV	
		LM4040B		± 6.0	± 26		
		LM4040C		± 15	± 34		
		LM4040D		± 30	± 59		
Minimum Operating Current	$I_{R\text{MIN}}$	LM4040A/B/C		45	67	μA	
		LM4040D		45	70		
Average Reverse Voltage Temperature Coefficient (Note 2)	$\Delta V_R/\Delta T$	$I_R = 10\text{mA}$		± 20		ppm/ $^\circ\text{C}$	
		$I_R = 1\text{mA}$	LM4040A/B/C	± 15	± 100		
			LM4040D	± 15	± 150		
Reverse Breakdown Voltage Change with Operating Current Change		$I_{R\text{MIN}} \leq I_R \leq 1\text{mA}$	LM4040A/B/C	0.3	1.0	mV	
			LM4040D	0.3	1.2		
		$1\text{mA} \leq I_R \leq 15\text{mA}$	LM4040A/B/C	2.5	8.0		
			LM4040D	2.5	10.0		
Reverse Dynamic Impedance (Note 3)	Z_R	$I_R = 1\text{mA}$, $f = 120\text{Hz}$, $I_{AC} = 0.1I_R$	LM4040A/B	0.3	0.8	Ω	
			LM4040C	0.3	0.9		
			LM4040D	0.3	1.1		
Wideband Noise	e_N	$I_R = 100\mu\text{A}$, $10\text{Hz} \leq f \leq 10\text{kHz}$		50		μV_{RMS}	
Reverse Breakdown Voltage Long-Term Stability	ΔV_R	$T = 1000\text{h}$		120		ppm	

Improved Precision Micropower Shunt Voltage Reference with Multiple Reverse Breakdown Voltages

ELECTRICAL CHARACTERISTICS—4.096V

($I_R = 100\mu\text{A}$, $T_A = T_{\text{MIN}}$ to T_{MAX} , unless otherwise noted. Typical values are at $T_A = +25^\circ\text{C}$.) (Note 1)

PARAMETER	SYMBOL	CONDITIONS		MIN	TYP	MAX	UNITS
Reverse Breakdown Voltage	V_R	$T_A = +25^\circ\text{C}$	LM4040A (0.1%)	4.092	4.096	4.100	V
			LM4040B (0.2%)	4.088	4.096	4.104	
			LM4040C (0.5%)	4.076	4.096	4.116	
			LM4040D (1.0%)	4.055	4.096	4.137	
Reverse Breakdown Voltage Tolerance (Note 2)	V_R	LM4040A			± 4.1	± 31	mV
		LM4040B			± 8.2	± 35	
		LM4040C			± 20	± 47	
		LM4040D			± 41	± 81	
Minimum Operating Current	$I_{R\text{MIN}}$	LM4040A/B/C			50	73	μA
		LM4040D			50	78	
Average Reverse Voltage Temperature Coefficient (Note 2)	$\Delta V_R/\Delta T$	$I_R = 10\text{mA}$			± 30		ppm/ $^\circ\text{C}$
		$I_R = 1\text{mA}$	LM4040A/B/C		± 20	± 100	
			LM4040D		± 20	± 150	
		$I_R = 100\mu\text{A}$			± 15		
Reverse Breakdown Voltage Change with Operating Current Change		$I_{R\text{MIN}} \leq I_R \leq 1\text{mA}$	LM4040A/B/C		0.5	1.2	mV
			LM4040D		0.5	1.5	
		$1\text{mA} \leq I_R \leq 15\text{mA}$	LM4040A/B/C		3.0	10.0	
			LM4040D		3.0	13.0	
Reverse Dynamic Impedance (Note 3)	Z_R	$I_R = 1\text{mA}$, $f = 120\text{Hz}$, $I_{AC} = 0.1I_R$	LM4040A/B/C		0.5	1.0	Ω
			LM4040D		0.5	1.3	
Wideband Noise	e_N	$I_R = 100\mu\text{A}$, $10\text{Hz} \leq f \leq 10\text{kHz}$			64		μVRMS
Reverse Breakdown Voltage Long-Term Stability	ΔV_R	$T = 1000\text{h}$			120		ppm

Improved Precision Micropower Shunt Voltage Reference with Multiple Reverse Breakdown Voltages

LM4040

ELECTRICAL CHARACTERISTICS—5.000V

($I_R = 100\mu\text{A}$, $T_A = T_{\text{MIN}}$ to T_{MAX} , unless otherwise noted. Typical values are at $T_A = +25^\circ\text{C}$.) (Note 1)

PARAMETER	SYMBOL	CONDITIONS		MIN	TYP	MAX	UNITS
Reverse Breakdown Voltage	V_R	$T_A = +25^\circ\text{C}$	LM4040A (0.1%)	4.995	5.000	5.005	V
			LM4040B (0.2%)	4.990	5.000	5.010	
			LM4040C (0.5%)	4.975	5.000	5.025	
			LM4040D (1.0%)	4.950	5.000	5.050	
Reverse Breakdown Voltage Tolerance (Note 2)	V_R	LM4040A		± 5.0	± 38	mV	
		LM4040B		± 10	± 43		
		LM4040C		± 25	± 58		
		LM4040D		± 50	± 99		
Minimum Operating Current	$I_{R\text{MIN}}$	LM4040A/B/C		54	80	μA	
		LM4040D		54	85		
Average Reverse Voltage Temperature Coefficient (Note 2)	$\Delta V_R / \Delta T$	$I_R = 10\text{mA}$		± 30		ppm/ $^\circ\text{C}$	
		$I_R = 1\text{mA}$	LM4040A/B/C	± 20	± 100		
			LM4040D	± 20	± 150		
Reverse Breakdown Voltage Change with Operating Current Change		$I_{R\text{MIN}} \leq I_R \leq 1\text{mA}$	LM4040A/B/C	0.5	1.4	mV	
			LM4040D	0.5	1.8		
		$1\text{mA} \leq I_R \leq 15\text{mA}$	LM4040A/B/C	3.5	12.0		
			LM4040D	3.5	15.0		
Reverse Dynamic Impedance (Note 3)	Z_R	$I_R = 1\text{mA}$, $f = 120\text{Hz}$, $I_{AC} = 0.1I_R$	LM4040A/B/C	0.5	1.1	Ω	
			LM4040D	0.5	1.5		
Wideband Noise	e_N	$I_R = 100\mu\text{A}$, $10\text{Hz} \leq f \leq 10\text{kHz}$		80		μVRMS	
Reverse Breakdown Voltage Long-Term Stability	ΔV_R	$T = 1000\text{h}$		120		ppm	

Note 1: All devices are 100% production tested at $+25^\circ\text{C}$ and are guaranteed by design for $T_A = T_{\text{MIN}}$ to T_{MAX} , as specified.

Note 2: The overtemperature limit for Reverse Breakdown Voltage Tolerance is defined as the room-temperature Reverse Breakdown Voltage Tolerance $\pm[(\Delta V_R / \Delta T)(\text{max}\Delta T)(V_R)]$, where $\Delta V_R / \Delta T$ is the V_R temperature coefficient, $\text{max}\Delta T$ is the maximum difference in temperature from the reference point of $+25^\circ\text{C}$ to T_{MIN} or T_{MAX} , and V_R is the reverse breakdown voltage. The total overtemperature tolerance for the different grades in the temperature range where $\text{max}\Delta T = +65^\circ\text{C}$ is shown below:

A grade: $\pm 0.75\% = \pm 0.1\% \pm 100\text{ppm}/^\circ\text{C} \times 65^\circ\text{C}$

B grade: $\pm 0.85\% = \pm 0.2\% \pm 100\text{ppm}/^\circ\text{C} \times 65^\circ\text{C}$

C grade: $\pm 1.15\% = \pm 0.5\% \pm 100\text{ppm}/^\circ\text{C} \times 65^\circ\text{C}$

D grade: $\pm 1.98\% = \pm 1.0\% \pm 150\text{ppm}/^\circ\text{C} \times 65^\circ\text{C}$

The total over-temperature tolerance for the different grades in the extended temperature range where $\text{max}\Delta T = +100^\circ\text{C}$ is shown below:

A grade: $\pm 1.1\% = \pm 0.1\% \pm 100\text{ppm}/^\circ\text{C} \times 100^\circ\text{C}$

B grade: $\pm 1.2\% = \pm 0.2\% \pm 100\text{ppm}/^\circ\text{C} \times 100^\circ\text{C}$

C grade: $\pm 1.5\% = \pm 0.5\% \pm 100\text{ppm}/^\circ\text{C} \times 100^\circ\text{C}$

D grade: $\pm 2.5\% = \pm 1.0\% \pm 150\text{ppm}/^\circ\text{C} \times 100^\circ\text{C}$

Therefore, as an example, the A-grade LM4040-2.5 has an over-temperature reverse breakdown voltage tolerance of $\pm 2.5\text{V} \times 0.75\% = \pm 19\text{mV}$.

Note 3: Guaranteed by design.

Improved Precision Micropower Shunt Voltage Reference with Multiple Reverse Breakdown Voltages

Typical Operating Characteristics

($I_R = 100\mu\text{A}$, SC70-3 package, $T_A = +25^\circ\text{C}$, unless otherwise noted.)

REVERSE CHARACTERISTICS AND MINIMUM OPERATING CURRENT

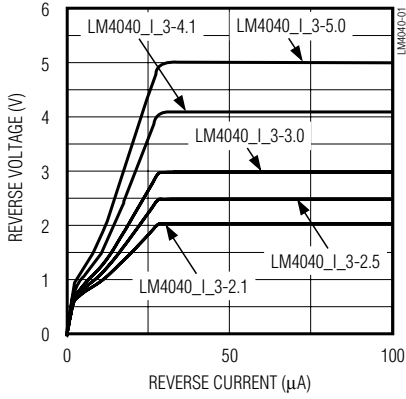

LM4040-2.5V TEMPERATURE DRIFT

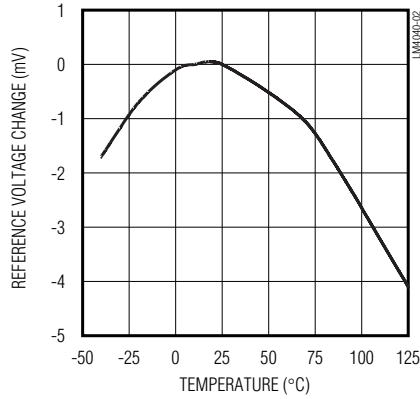

LM4040-5.0V TEMPERATURE DRIFT

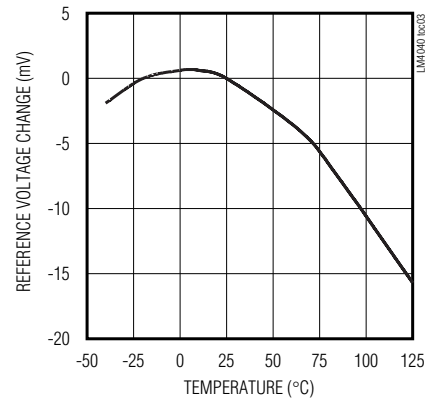

LM4040-2.5V REVERSE VOLTAGE vs. I_{SHUNT}

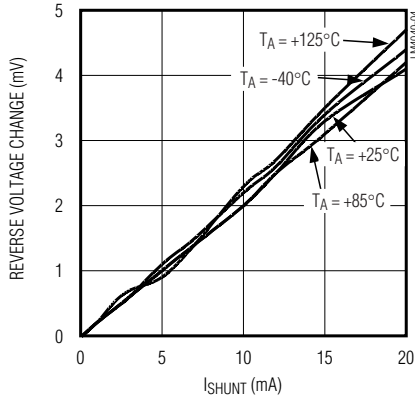

LM4040-5.0V REVERSE VOLTAGE vs. I_{SHUNT}

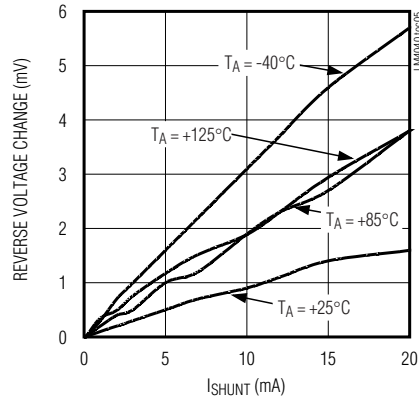

Improved Precision Micropower Shunt Voltage Reference with Multiple Reverse Breakdown Voltages

Typical Operating Characteristics (continued)

($I_R = 100\mu\text{A}$, SC70-3 package, $T_A = +25^\circ\text{C}$, unless otherwise noted.)

LM4040

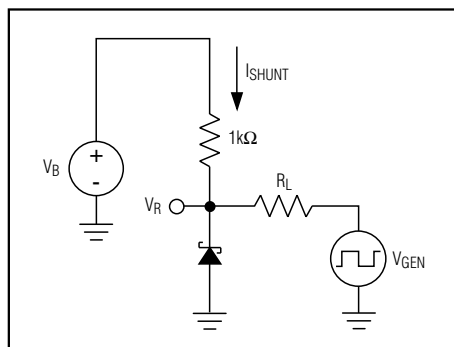
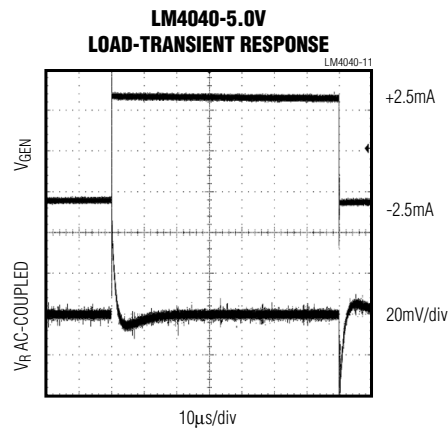
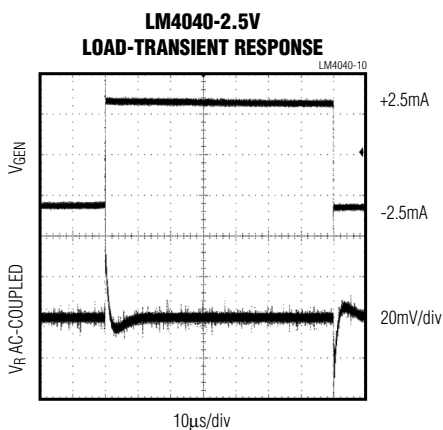
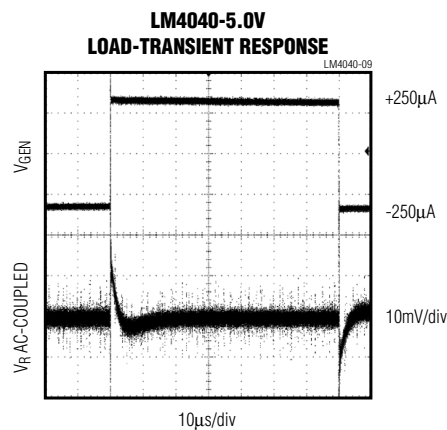
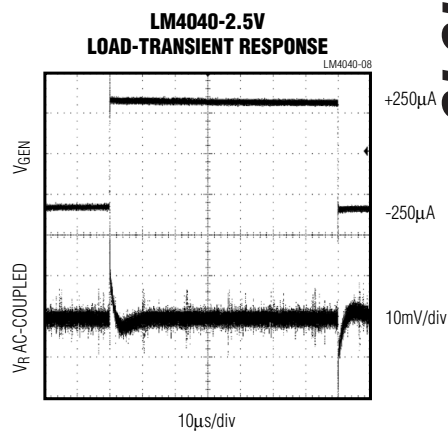
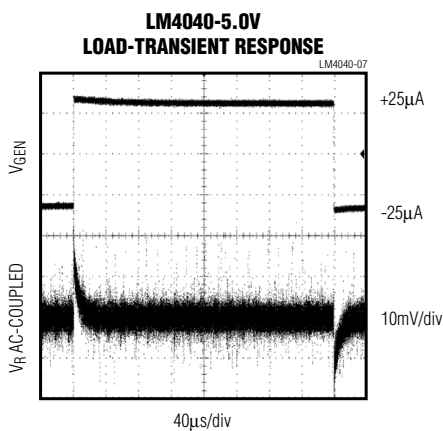
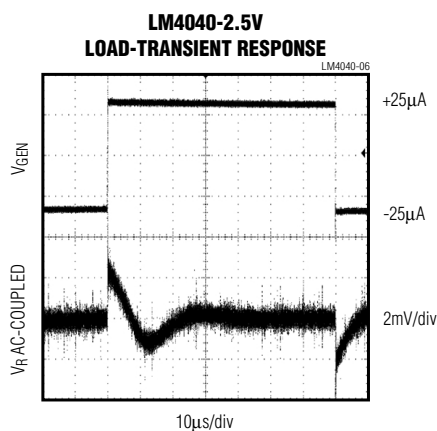

Figure 1. Load-Transient Test Circuit

Improved Precision Micropower Shunt Voltage Reference with Multiple Reverse Breakdown Voltages

Typical Operating Characteristics (continued)

($I_R = 100\mu\text{A}$, SC70-3 package, $T_A = +25^\circ\text{C}$, unless otherwise noted.)

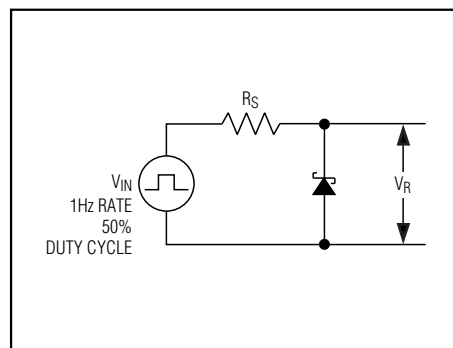
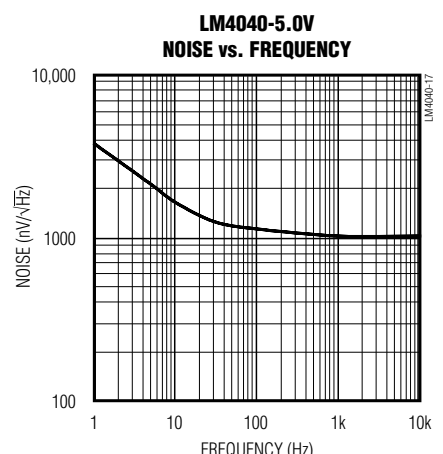
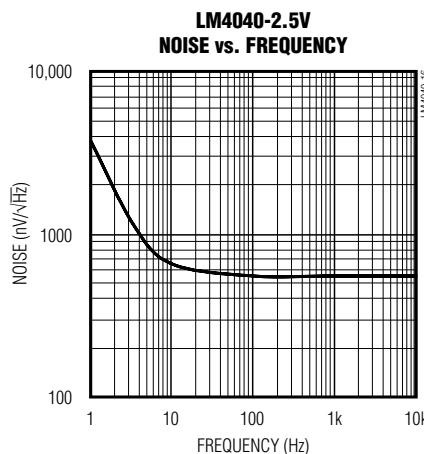
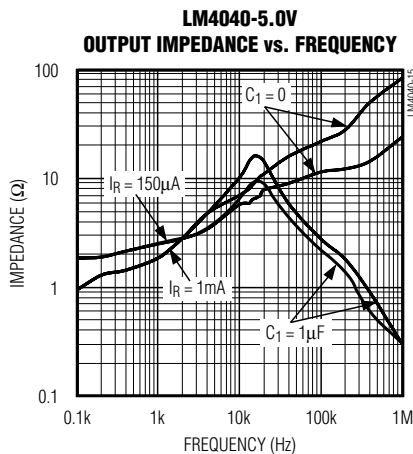
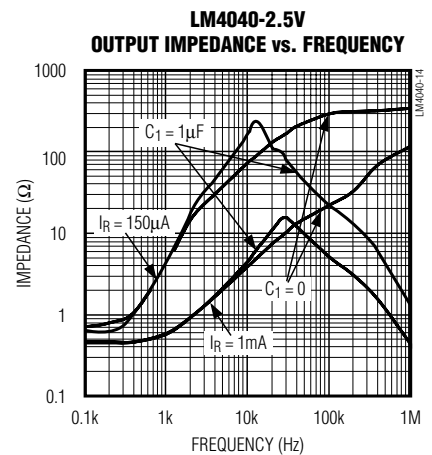
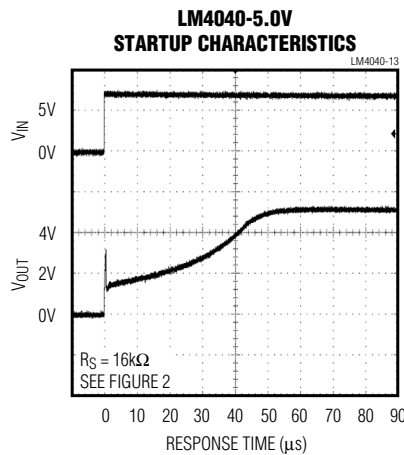
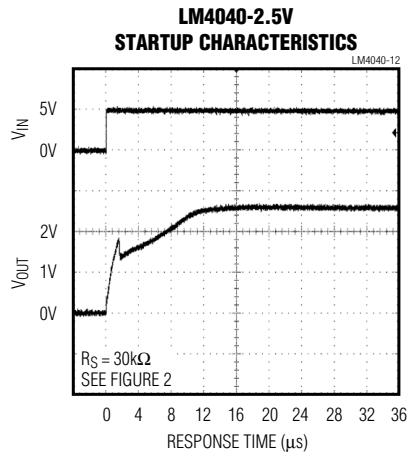

Figure 2. Startup Characteristics Test Circuit

Improved Precision Micropower Shunt Voltage Reference with Multiple Reverse Breakdown Voltages

Pin Description

PIN	NAME	FUNCTION
1	+	Positive Terminal of the Shunt Reference
2	-	Negative Terminal of the Shunt Reference
3	N.C.	No connection. Leave this pin unconnected or connected to Pin 2.

Detailed Description

The LM4040 shunt references use the bandgap principle to produce a stable, accurate voltage. The device behaves similarly to an ideal zener diode; a fixed voltage is maintained across its output terminals when biased with 60µA to 15mA of reverse current. The LM4040 behaves similarly to a silicon diode when biased with forward currents up to 10mA.

Figure 3 shows a typical operating circuit. The LM4040 is ideal for providing a stable reference from a high-voltage power supply.

Applications Information

The LM4040's internal pass transistor is used to maintain a constant output voltage (V_{SHUNT}) by sinking the necessary amount of current across a source resistor. The source resistance (R_S) is determined from the load current (I_{LOAD}) range, supply voltage (V_S) variations, V_{SHUNT} , and desired quiescent current.

Choose the value of R_S when V_S is at a minimum and I_{LOAD} is at a maximum. Maintain a minimum I_{SHUNT} of 60µA at all times. The R_S value should be large enough to keep I_{SHUNT} less than 15mA for proper regulation when V_S is maximum and I_{LOAD} is at a minimum. To prevent damage to the device, I_{SHUNT} should never exceed 20mA.

Therefore, the value of R_S is bounded by the following equation:

$$\frac{[V_S(\text{MIN}) - V_R]}{[60\mu\text{A} + I_{LOAD}(\text{MAX})]} > R_S > \frac{[V_S(\text{MAX}) - V_R]}{[20\text{mA} + I_{LOAD}(\text{MIN})]}$$

Choosing a larger resistance minimizes the total power dissipation in the circuit by reducing the shunt current ($P_{D(TOTAL)} = V_S \times I_{SHUNT}$). Provide a safety margin to incorporate the worst-case tolerance of the resistor used. Ensure that the resistor's power rating is adequate, using the following general power equation:

$$P_{DR} = I_{SHUNT} \times (V_S(\text{MAX}) - V_{SHUNT})$$

Output Capacitance

The LM4040 does not require an external capacitor for frequency stability and is stable for any output capacitance.

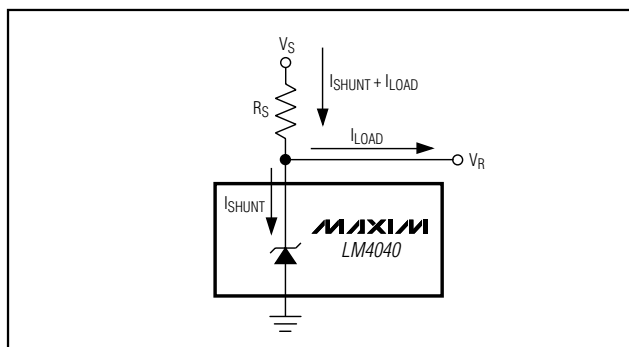

Figure 3. Typical Operating Circuit

Temperature Performance

The LM4040 typically exhibits an output voltage temperature coefficient within $\pm 15\text{ppm}/^\circ\text{C}$. The polarity of the temperature coefficient may be different from one device to another; some may have positive coefficients, and others may have negative coefficients.

High Temperature Operation

The maximum junction temperature of the LM4040 is $+150^\circ\text{C}$. The maximum operating temperature for the LM4040_E_ is $+125^\circ\text{C}$. At a maximum load current of 15mA and a maximum output voltage of 5V, the part will dissipate 75mW of power. The power dissipation limits of the 3-pin SC70 call for a derating value of 2.17mW/ $^\circ\text{C}$ above $+70^\circ\text{C}$ and thus for 75mW of power dissipation, the part will self-heat to 35.56°C above ambient temperature. If the ambient temperature is $+125^\circ\text{C}$, the part operates at 159.56°C , thereby exceeding the maximum junction temperature value of $+150^\circ\text{C}$. For high-temperature operation, care must be taken to ensure the combination of ambient temperature, output power dissipation and package thermal resistance does not conspire to raise the device temperature beyond that listed in the *Absolute Maximum Ratings*. Either reduce the output load current or the ambient temperature to keep the part within the limits.

Chip Information

TRANSISTOR COUNT: 60

PROCESS: BiCMOS

Improved Precision Micropower Shunt Voltage Reference with Multiple Reverse Breakdown Voltages

Ordering Information

PART	OUTPUT VOLTAGE (V)	INITIAL ACCURACY (%)	TEMPCO (ppm/°C)	TEMP RANGE	PIN-PACKAGE	TOP MARK
LM4040AIM3-2.1-T	2.048	0.1	100	-40°C to +85°C	3 SOT23-3	FZEF
LM4040AIX3-2.1-T	2.048	0.1	100	-40°C to +85°C	3 SC70-3	ABJ
LM4040BIM3-2.1-T	2.048	0.2	100	-40°C to +85°C	3 SOT23-3	FZEG
LM4040BIX3-2.1-T	2.048	0.2	100	-40°C to +85°C	3 SC70-3	ABK
LM4040CIM3-2.1-T	2.048	0.5	100	-40°C to +85°C	3 SOT23-3	FZEH
LM4040CIX3-2.1-T	2.048	0.5	100	-40°C to +85°C	3 SC70-3	ABL
LM4040DIM3-2.1-T	2.048	1.0	150	-40°C to +85°C	3 SOT23-3	FZEI
LM4040DIX3-2.1-T	2.048	1.0	150	-40°C to +85°C	3 SC70-3	ABM
LM4040AEM3-2.1-T	2.048	0.1	100	-40°C to +125°C	3 SOT23-3	FZNG
LM4040AEX3-2.1-T	2.048	0.1	100	-40°C to +125°C	3 SC70-3	ALF
LM4040BEM3-2.1-T	2.048	0.2	100	-40°C to +125°C	3 SOT23-3	FZNH
LM4040BEX3-2.1-T	2.048	0.2	100	-40°C to +125°C	3 SC70-3	ALG
LM4040CEM3-2.1-T	2.048	0.5	100	-40°C to +125°C	3 SOT23-3	FZNI
LM4040CEX3-2.1-T	2.048	0.5	100	-40°C to +125°C	3 SC70-3	ALH
LM4040DEM3-2.1-T	2.048	1.0	150	-40°C to +125°C	3 SOT23-3	FZNJ
LM4040DEX3-2.1-T	2.048	1.0	150	-40°C to +125°C	3 SC70-3	ALI
LM4040AIM3-2.5-T	2.500	0.1	100	-40°C to +85°C	3 SOT23-3	FZEJ
LM4040AIX3-2.5-T	2.500	0.1	100	-40°C to +85°C	3 SC70-3	ABN
LM4040BIM3-2.5-T	2.500	0.2	100	-40°C to +85°C	3 SOT23-3	FZEK
LM4040BIX3-2.5-T	2.500	0.2	100	-40°C to +85°C	3 SC70-3	ABO
LM4040CIM3-2.5-T	2.500	0.5	100	-40°C to +85°C	3 SOT23-3	FZEL
LM4040CIX3-2.5-T	2.500	0.5	100	-40°C to +85°C	3 SC70-3	ABP
LM4040DIM3-2.5-T	2.500	1.0	150	-40°C to +85°C	3 SOT23-3	FZEM
LM4040DIX3-2.5-T	2.500	1.0	150	-40°C to +85°C	3 SC70-3	ABQ
LM4040AEM3-2.5-T	2.500	0.1	100	-40°C to +125°C	3 SOT23-3	FZNK
LM4040AEX3-2.5-T	2.500	0.1	100	-40°C to +125°C	3 SC70-3	ALJ
LM4040BEM3-2.5-T	2.500	0.2	100	-40°C to +125°C	3 SOT23-3	FZNL
LM4040BEX3-2.5-T	2.500	0.2	100	-40°C to +125°C	3 SC70-3	ALK
LM4040CEM3-2.5-T	2.500	0.5	100	-40°C to +125°C	3 SOT23-3	FZNM
LM4040CEX3-2.5-T	2.500	0.5	100	-40°C to +125°C	3 SC70-3	ALL
LM4040DEM3-2.5-T	2.500	1.0	150	-40°C to +125°C	3 SOT23-3	FZNN
LM4040DEX3-2.5-T	2.500	1.0	150	-40°C to +125°C	3 SC70-3	ALM
LM4040AIM3-3.0-T	3.000	0.1	100	-40°C to +85°C	3 SOT23-3	FZEN
LM4040AIX3-3.0-T	3.000	0.1	100	-40°C to +85°C	3 SC70-3	ABR
LM4040BIM3-3.0-T	3.000	0.2	100	-40°C to +85°C	3 SOT23-3	FZEO
LM4040BIX3-3.0-T	3.000	0.2	100	-40°C to +85°C	3 SC70-3	ABS
LM4040CIM3-3.0-T	3.000	0.5	100	-40°C to +85°C	3 SOT23-3	FZEP
LM4040CIX3-3.0-T	3.000	0.5	100	-40°C to +85°C	3 SC70-3	ABT
LM4040DIM3-3.0-T	3.000	1.0	150	-40°C to +85°C	3 SOT23-3	FZEQ
LM4040DIX3-3.0-T	3.000	1.0	150	-40°C to +85°C	3 SC70-3	ABU
LM4040AEM3-3.0-T	3.000	0.1	100	-40°C to +125°C	3 SOT23-3	FZNO
LM4040AEX3-3.0-T	3.000	0.1	100	-40°C to +125°C	3 SC70-3	ALN
LM4040BEM3-3.0-T	3.000	0.2	100	-40°C to +125°C	3 SOT23-3	FZNP
LM4040BEX3-3.0-T	3.000	0.2	100	-40°C to +125°C	3 SC70-3	ALO
LM4040CEM3-3.0-T	3.000	0.5	100	-40°C to +125°C	3 SOT23-3	FZNQ

Improved Precision Micropower Shunt Voltage Reference with Multiple Reverse Breakdown Voltages

Ordering Information (continued)

LM4040

PART	OUTPUT VOLTAGE (V)	INITIAL ACCURACY (%)	TEMPCO (ppm/°C)	TEMP RANGE	PIN-PACKAGE	TOP MARK
LM4040CEX3-3.0-T	3.000	0.5	100	-40°C to +125°C	3 SC70-3	ALP
LM4040DEM3-3.0-T	3.000	1.0	150	-40°C to +125°C	3 SOT23-3	FZNR
LM4040DEX3-3.0-T	3.000	1.0	150	-40°C to +125°C	3 SC70-3	ALQ
LM4040AEX3-3.3-T	3.300	0.1	100	-40°C to +125°C	3 SC70-3	ANY
LM4040BEX3-3.3-T	3.300	0.2	100	-40°C to +125°C	3 SC70-3	ANZ
LM4040CEX3-3.3-T	3.300	0.5	100	-40°C to +125°C	3 SC70-3	AOA
LM4040DEX3-3.3-T	3.300	1.0	150	-40°C to +125°C	3 SC70-3	AOB
LM4040AIM3-4.1-T	4.096	0.1	100	-40°C to +85°C	3 SOT23-3	FZER
LM4040AIX3-4.1-T	4.096	0.1	100	-40°C to +85°C	3 SC70-3	ABV
LM4040BIM3-4.1-T	4.096	0.2	100	-40°C to +85°C	3 SOT23-3	FZES
LM4040BIX3-4.1-T	4.096	0.2	100	-40°C to +85°C	3 SC70-3	ABW
LM4040CIM3-4.1-T	4.096	0.5	100	-40°C to +85°C	3 SOT23-3	FZET
LM4040CIX3-4.1-T	4.096	0.5	100	-40°C to +85°C	3 SC70-3	ABX
LM4040DIM3-4.1-T	4.096	1.0	150	-40°C to +85°C	3 SOT23-3	FZEU
LM4040DIX3-4.1-T	4.096	1.0	150	-40°C to +85°C	3 SC70-3	ABY
LM4040AEM3-4.1-T	4.096	0.1	100	-40°C to +125°C	3 SOT23-3	FZNS
LM4040AEX3-4.1-T	4.096	0.1	100	-40°C to +125°C	3 SC70-3	ALR
LM4040BEM3-4.1-T	4.096	0.2	100	-40°C to +125°C	3 SOT23-3	FZNT
LM4040BEX3-4.1-T	4.096	0.2	100	-40°C to +125°C	3 SC70-3	ALS
LM4040CEM3-4.1-T	4.096	0.5	100	-40°C to +125°C	3 SOT23-3	FZNU
LM4040CEX3-4.1-T	4.096	0.5	100	-40°C to +125°C	3 SC70-3	ALT
LM4040DEM3-4.1-T	4.096	1.0	150	-40°C to +125°C	3 SOT23-3	FZNV
LM4040DEX3-4.1-T	4.096	1.0	150	-40°C to +125°C	3 SC70-3	ALU
LM4040AIM3-5.0-T	5.000	0.1	100	-40°C to +85°C	3 SOT23-3	FZEV
LM4040AIX3-5.0-T	5.000	0.1	100	-40°C to +85°C	3 SC70-3	ABZ
LM4040BIM3-5.0-T	5.000	0.2	100	-40°C to +85°C	3 SOT23-3	FZEW
LM4040BIX3-5.0-T	5.000	0.2	100	-40°C to +85°C	3 SC70-3	ACA
LM4040CIM3-5.0-T	5.000	0.5	100	-40°C to +85°C	3 SOT23-3	FZEX
LM4040CIX3-5.0-T	5.000	0.5	100	-40°C to +85°C	3 SC70-3	ACB
LM4040DIM3-5.0-T	5.000	1.0	150	-40°C to +85°C	3 SOT23-3	FZEY
LM4040DIX3-5.0-T	5.000	1.0	150	-40°C to +85°C	3 SC70-3	ACC
LM4040AEM3-5.0-T	5.000	0.1	100	-40°C to +125°C	3 SOT23-3	FZNW
LM4040AEX3-5.0-T	5.000	0.1	100	-40°C to +125°C	3 SC70-3	ALV
LM4040BEM3-5.0-T	5.000	0.2	100	-40°C to +125°C	3 SOT23-3	FZNX
LM4040BEX3-5.0-T	5.000	0.2	100	-40°C to +125°C	3 SC70-3	ALW
LM4040CEM3-5.0-T	5.000	0.5	100	-40°C to +125°C	3 SOT23-3	FZNY
LM4040CEX3-5.0-T	5.000	0.5	100	-40°C to +125°C	3 SC70-3	ALX

Improved Precision Micropower Shunt Voltage Reference with Multiple Reverse Breakdown Voltages

Package Information

(The package drawing(s) in this data sheet may not reflect the most current specifications. For the latest package outline information, go to www.maxim-ic.com/packages.)

NOTES:

1. D&E DO NOT INCLUDE MOLD FLASH.
2. MOLD FLASH OR PROTRUSIONS NOT TO EXCEED .15mm (.006").
3. CONTROLLING DIMENSION: MILLIMETERS.
4. REFERENCE JEDEC TO236.
5. LEADS TO BE COPLANAR WITHIN 0.10mm.

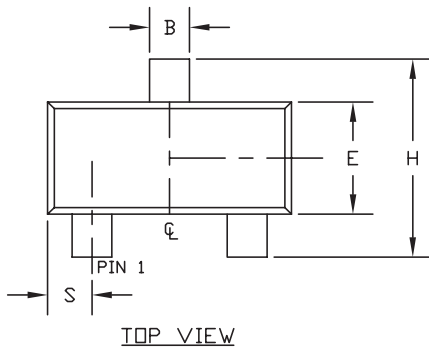

DIM	INCHES		MILLIMETERS	
	MIN	MAX	MIN	MAX
A	0.035	0.044	0.890	1.120
A1	0.001	0.004	0.013	0.100
B	0.015	0.020	0.370	0.510
C	0.003	0.071	0.085	0.180
D	0.110	0.120	2.800	3.040
E	0.047	0.055	1.200	1.400
e	0.070	0.081	1.780	2.050
H	0.083	0.104	2.100	2.640
L	0.008	0.017	0.210	0.420
L1	0.021	REF	0.54	REF
S	0.018	0.024	0.45	0.60
α	0°	8°	0°	8°

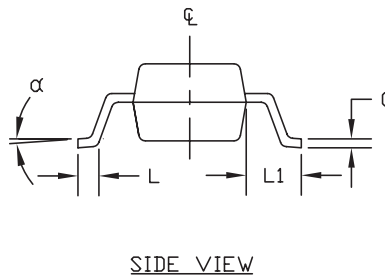
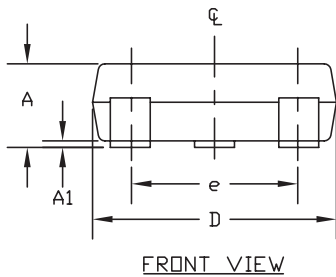

<small>PROPRIETARY INFORMATION</small>		
<small>TITLE:</small> PACKAGE OUTLINE, 3L SOT-23		
<small>APPROVAL</small>	<small>DOCUMENT CONTROL NO.</small> 21-0051	<small>REV.</small> E 1/1

SOT23 LEPS

Improved Precision Micropower Shunt Voltage Reference with Multiple Reverse Breakdown Voltages

Package Information (continued)

(The package drawing(s) in this data sheet may not reflect the most current specifications. For the latest package outline information, go to www.maxim-ic.com/packages.)

LM4040

SC70, 3L-EPS

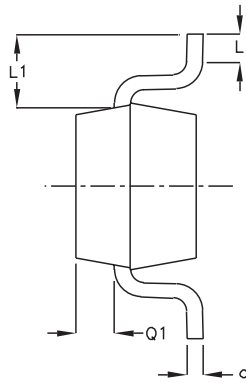
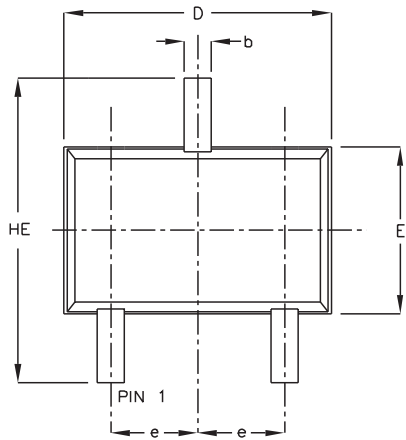

SYMBOL	MIN	MAX
e	0.65	BSC
D	1.80	2.20
b	0.25	0.40
E	1.15	1.35
HE	1.80	2.40
Q1	0.10	0.40
A2	0.80	1.00
A1	0.00	0.10
A	0.80	1.10
c	0.10	0.18
L	0.10	0.30
L1	0.425	TYP.

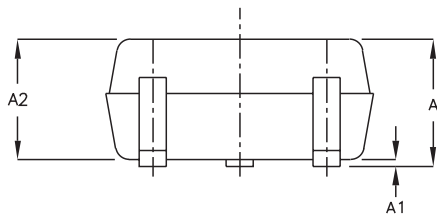

NOTE:

1. ALL DIMENSIONS ARE IN MILLIMETERS
2. DIMENSIONS ARE INCLUSIVE OF PLATING
3. DIMENSIONS ARE EXCLUSIVE OF MOLD FLASH & METAL BURR
4. ALL SPECIFICATIONS COMPLY TO EIAJ SC70
5. COPLANARITY 4 MILS. MAX.

MAXIM			
<small>PROPRIETARY INFORMATION</small>			
<small>TITLE:</small>			
PACKAGE OUTLINE, SC70, 3L			
<small>APPROVAL</small>	<small>DOCUMENT CONTROL NO.</small>	<small>REV</small>	<small>1/1</small>
	21-0075	B	

Maxim cannot assume responsibility for use of any circuitry other than circuitry entirely embodied in a Maxim product. No circuit patent licenses are implied. Maxim reserves the right to change the circuitry and specifications without notice at any time.

15 _____ **Maxim Integrated Products, 120 San Gabriel Drive, Sunnyvale, CA 94086 408-737-7600**