



IF Digitally Controlled Variable-Gain Amplifier

MAX2027

General Description

The MAX2027 high-performance, digitally controlled variable-gain amplifier is designed for use from 50MHz to 400MHz.

The device integrates a digitally controlled attenuator and a high-linearity IF amplifier in one package. Targeted for IF signal chains to adjust gain either dynamically or as a one-time channel gain setting, the MAX2027 is ideal for applications requiring high performance. The attenuator provides 23dB of attenuation range with $\pm 0.05\text{dB}$ state-to-state accuracy.

The MAX2027 is available in a thermally enhanced 20-pin TSSOP-EP package and operates over the -40°C to $+85^{\circ}\text{C}$ temperature range.

Applications

- Cellular Base Stations
- Receiver Gain Control
- Transmitter Gain Control
- Broadband Systems
- Automatic Test Equipment
- Terrestrial Links

Features

- ◆ 50MHz to 400MHz Frequency Range
- ◆ Variable Gain: -8dB to +15dB
- ◆ Output IP3: 35dBm (at All Gain Settings)
- ◆ Noise Figure: 4.7dB at Maximum Gain
- ◆ Digitally Controlled Gain with 1dB Resolution and $\pm 0.05\text{dB}$ State-to-State Accuracy

Ordering Information

PART	TEMP RANGE	PIN-PACKAGE
MAX2027EUP-T	-40°C to $+85^{\circ}\text{C}$	20 TSSOP-EP*

*EP = exposed pad.

Pin Configuration/ Functional Diagram

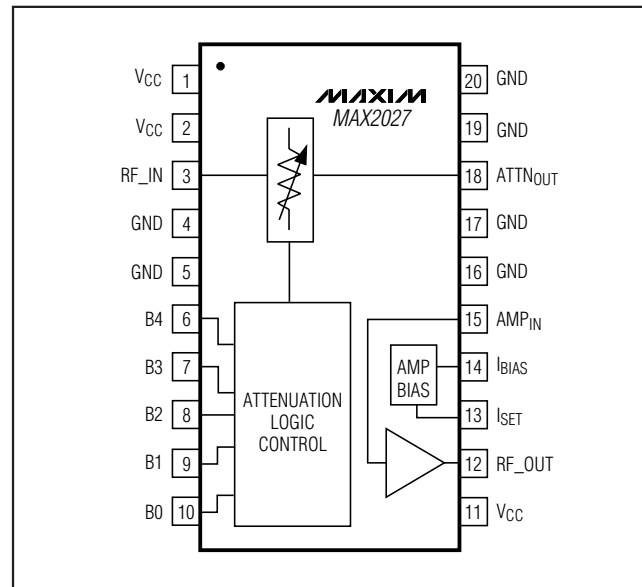

IF Digitally Controlled Variable-Gain Amplifier

ABSOLUTE MAXIMUM RATINGS

All Pins Input Voltage (except AMP _{IN} , I _{BIAS} , and I _{SET}) to GND.....	-0.3V to +5.5V	Continuous Power Dissipation (T _A = +70°C) 20-Pin TSSOP-EP (derate 21.7mW/°C above +70°C).....	1.7W
Input Voltage Levels (B0–B4).....	-0.3V to (V _{CC} + 0.5V)	Operating Temperature Range	-40°C to +85°C
Input Voltage Levels (AMP _{IN} and I _{BIAS}).....	-0.3V to +1.5V	Junction Temperature	+150°C
Input Voltage Levels (I _{SET}).....	-0.3V to +1.0V	Storage Temperature Range	-65°C to +165°C
RF Input Signal	20dBm	Lead Temperature (soldering, 10s)	+300°C
RF Output Signal.....	22dBm		

Stresses beyond those listed under "Absolute Maximum Ratings" may cause permanent damage to the device. These are stress ratings only, and functional operation of the device at these or any other conditions beyond those indicated in the operational sections of the specifications is not implied. Exposure to absolute maximum rating conditions for extended periods may affect device reliability.

DC ELECTRICAL CHARACTERISTICS

(Typical application circuit, V_{CC} = +4.75V to +5.25V, GND = 0V. No RF signals applied, and RF input and output ports are terminated with 50Ω. R₁ = 825Ω, T_A = -40°C to +85°C. Typical values are at V_{CC} = +5V and T_A = +25°C, unless otherwise noted.) (Notes 1, 2)

PARAMETER	SYMBOL	CONDITIONS	MIN	TYP	MAX	UNITS
SUPPLY						
Supply Voltage	V _{CC}		4.75	5.00	5.25	V
Supply Current	I _{CC}			60	75	mA
I _{SET} Current	I _{SET}			0.9		mA
CONTROL INPUTS/OUTPUTS						
Control Bits		Parallel		5		Bits
Input Logic High		(Note 3)	2			V
Input Logic Low					0.6	V
Input Leakage Current			-1.2		+1.2	μA

IF Digitally Controlled Variable-Gain Amplifier

MAX2027

AC ELECTRICAL CHARACTERISTICS

(Typical application circuit without matching, $V_{CC} = +4.75V$ to $+5.25V$, $GND = 0V$, max gain ($B0 = B1 = B2 = B3 = B4 = 0$), $R_1 = 825\Omega$, $P_{OUT} = 5dBm$, $f_{IN} = 50MHz$, 50Ω RF system impedance. Typical values are at $V_{CC} = +5V$ and $T_A = +25^\circ C$, unless otherwise noted.) (Notes 1, 2)

PARAMETER	SYMBOL	CONDITIONS	MIN	TYP	MAX	UNITS
Frequency Range	f_R		50		400	MHz
Gain	G	No attenuation		15.5		dB
Noise Figure	NF	Max gain		4.7		dB
Minimum Reverse Isolation		Max gain		22		dB
Output 1dB Compression Point	P_{1dB}	Max gain		20.6		dBm
2nd-Order Output Intercept Point	OIP2	$f_1 + f_2$, $f_1 = 50MHz$, $f_2 = 51MHz$, 5dBm/tone		42		dBm
3rd-Order Output Intercept Point	OIP3	All gain conditions, 5dBm/tone		34.7		dBm
2nd Harmonic	$2f_{IN}$			-44		dBc
3rd Harmonic	$3f_{IN}$			-68		dBc
RF Gain-Control Range				23		dB
Gain-Control Resolution				1		dB
Attenuation Absolute Accuracy		Compared to the ideal expected attenuation		0.15/ -0.05		dB
Attenuation Relative Accuracy		Between adjacent states		± 0.05		dB
Gain Drift Over Temperature		$T_A = -40^\circ C$ to $+85^\circ C$		± 0.1		dB
Gain Flatness Over 50MHz BW		Peak-to-peak for all settings, $F_{CENTER} = 75MHz$		0.1		dB
		Peak-to-peak for all settings, $F_{CENTER} = 200MHz$		0.2		
Attenuator Switching Time		50% control to 90% RF		40		ns
Input Return Loss		$f_R = 50MHz$ to $250MHz$, all gain conditions		15		dB
Output Return Loss		$f_R = 50MHz$ to $250MHz$, all gain conditions		15		dB

Note 1: Guaranteed by design and characterization.

Note 2: All limits reflect losses of external components. Output measurements are taken at RF OUT using the typical application circuit.

IF Digitally Controlled Variable-Gain Amplifier

Typical Operating Characteristics

(Typical application circuit, $V_{CC} = 5.0V$, max gain ($B_0 = B_1 = B_2 = B_3 = B_4 = 0$), $P_{OUT} = 5dBm$, $R_1 = 825\Omega$, $T_A = +25^\circ C$, unless otherwise noted.)

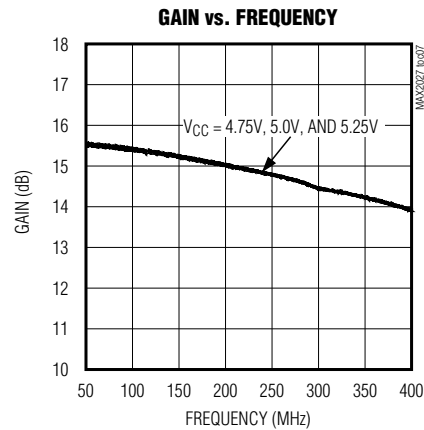
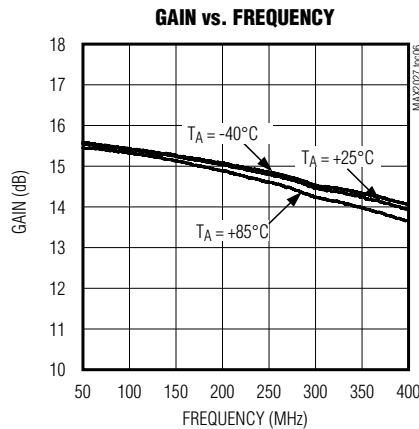
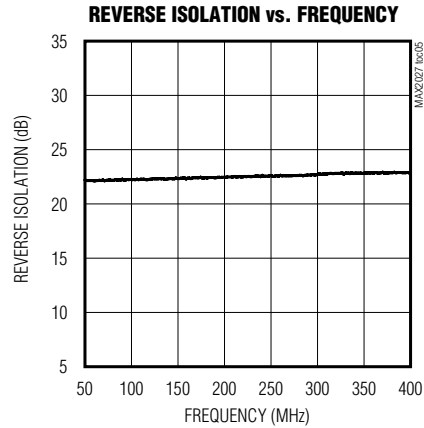
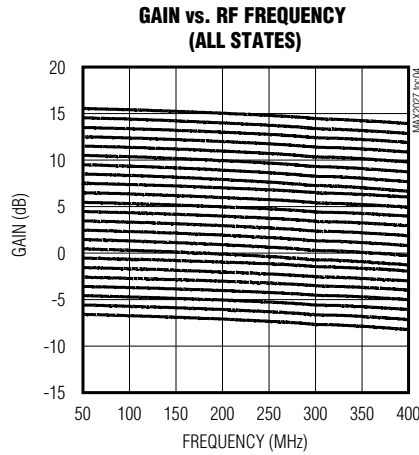
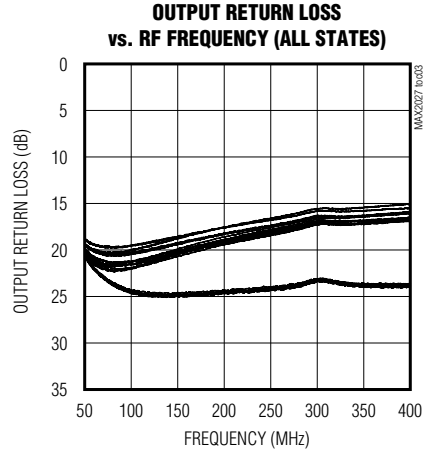
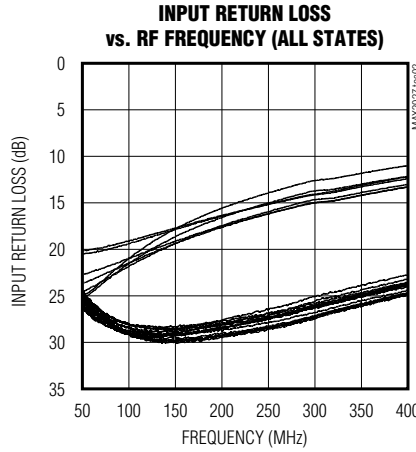
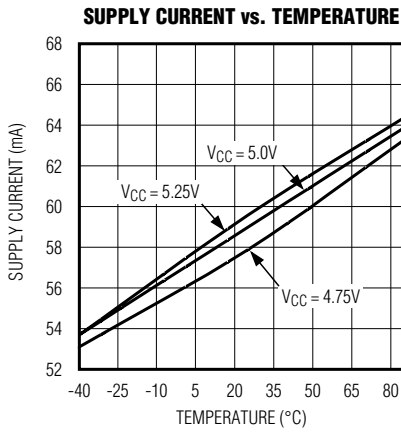

IF Digitally Controlled Variable-Gain Amplifier

MAX2027

Typical Operating Characteristics (continued)

(Typical application circuit, $V_{CC} = 5.0V$, max gain ($B0 = B1 = B2 = B3 = B4 = 0$), $P_{OUT} = 5dBm$, $R_1 = 825\Omega$, $T_A = +25^\circ C$, unless otherwise noted.)

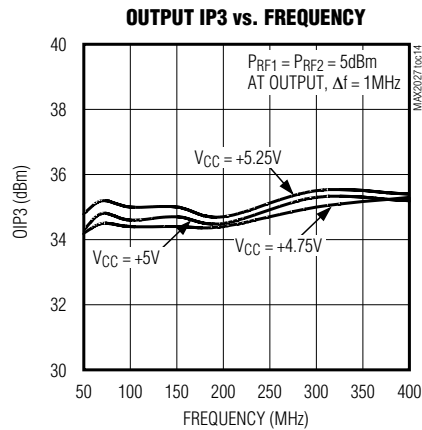
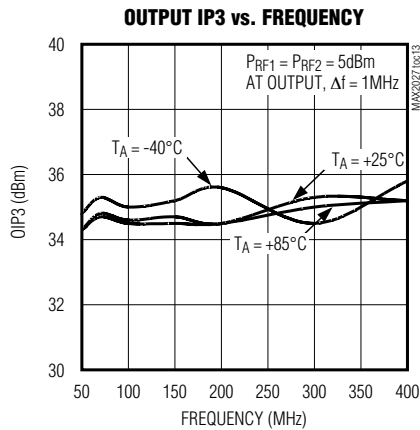
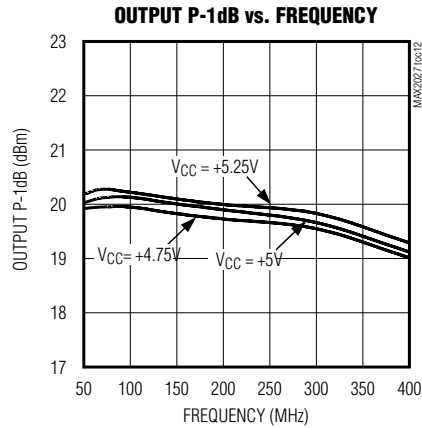
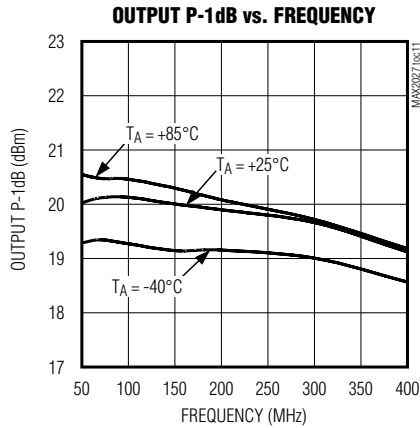
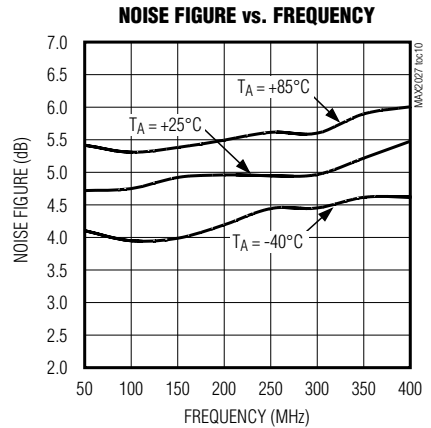
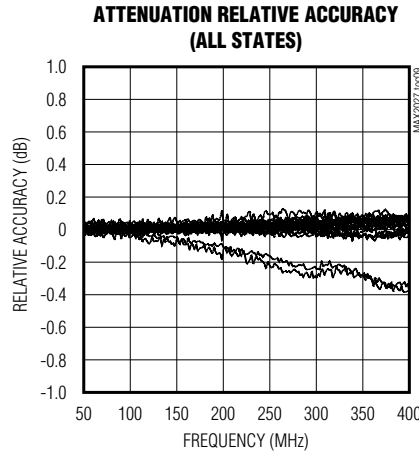
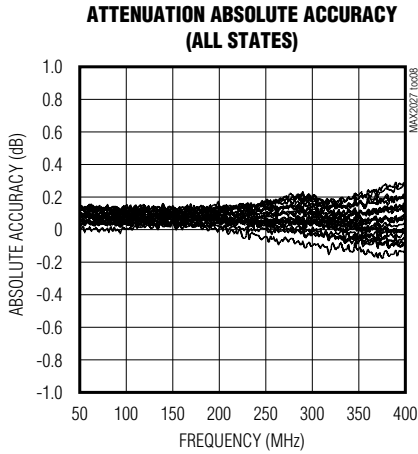

IF Digitally Controlled Variable-Gain Amplifier

Typical Operating Characteristics (continued)

(Typical application circuit, $V_{CC} = 5.0V$, max gain ($B0 = B1 = B2 = B3 = B4 = 0$), $P_{OUT} = 5dBm$, $R_1 = 825\Omega$, $T_A = +25^\circ C$, unless otherwise noted.)

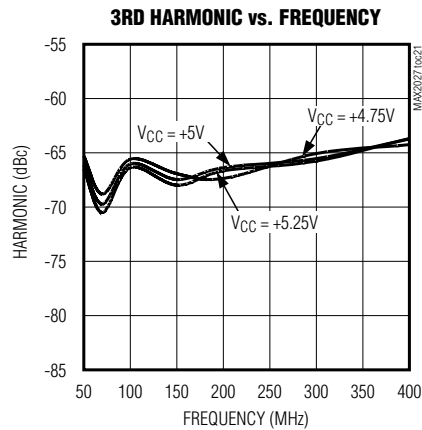
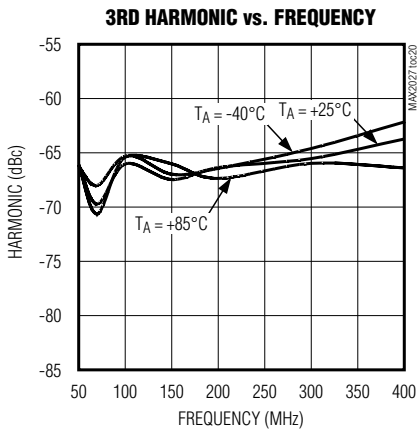
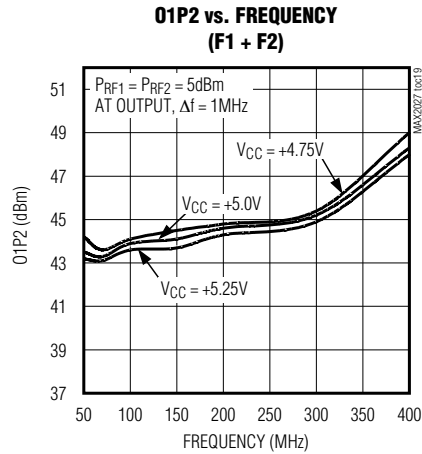
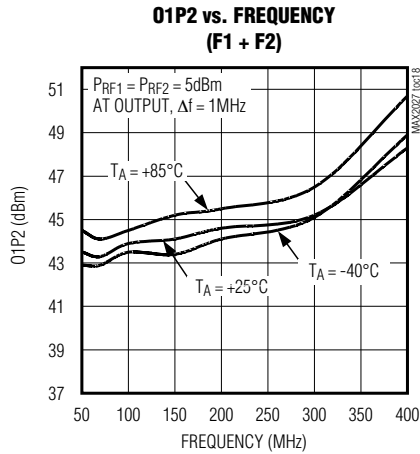
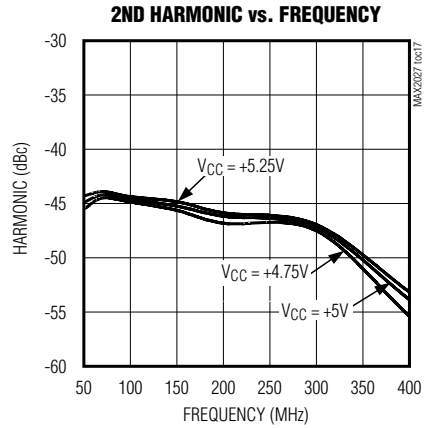
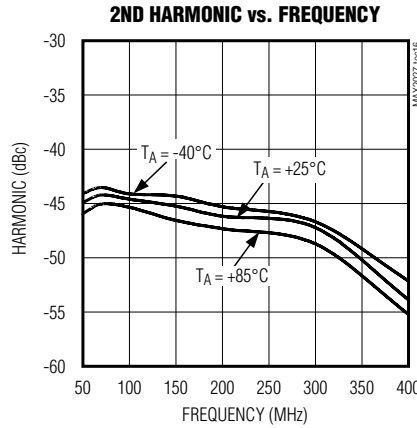
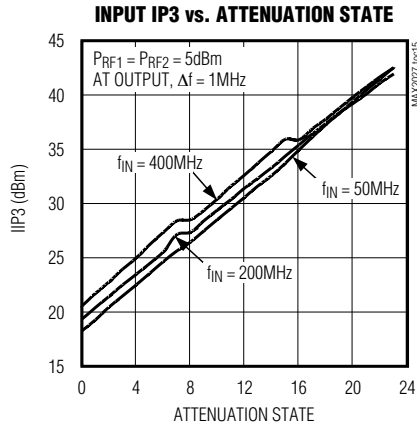

IF Digitally Controlled Variable-Gain Amplifier

MAX2027

Pin Description

PIN	NAME	FUNCTION
1, 2, 11	V _{CC}	Power Supply. Bypass to GND with capacitors as close to the pin as possible as shown in the typical application circuit (Figure 1).
3	RF_IN	Signal Input. See the typical application circuit for recommended component values. Requires an external DC-blocking capacitor.
4, 5, 16, 17, 19, 20, EP	GND	Ground. Use low-inductance layout techniques on PC board. Solder the exposed pad evenly to the board ground plane.
6–10	B4–B0	Gain-Control Bits. See Table 3 for gain setting.
12	RF_OUT	Signal Output. Requires an external pullup choke inductor (52mA typical current) to V _{CC} along with a DC-blocking capacitor (Figure 1).
13	I _{SET}	Connect an 825Ω resistor from I _{SET} to GND.
14	I _{BIAS}	Amplifier Bias. Connect to AMP _{IN} (pin 15) through a choke inductor (0.3mA typ).
15	AMP _{IN}	Amplifier Input. Requires a DC-coupling capacitor to allow biasing.
18	ATTN _{OUT}	Attenuator Output. Requires an external DC-blocking capacitor.

Detailed Description

The MAX2027 is a high-performance, digitally controlled variable-gain amplifier for use in applications from 50MHz to 400MHz.

The MAX2027 incorporates a digital attenuator with a 23dB selectable attenuation range followed by a fixed-gain, high-linearity amplifier. The attenuator is digitally controlled through five logic lines: B0–B4. This on-chip attenuator provides up to 23dB of attenuation with ±0.05dB state-to-state accuracy. The fixed-gain amplifier utilizes negative feedback to achieve high stability, gain, linearity, and wide bandwidth.

Applications Information

Input and Output Matching

The MAX2027 incorporates on-chip input and output matching for operation below 250MHz. Use a DC-blocking capacitor value of 1000pF for pins 3, 12, and 18 (see Figure 1). For operation above 250MHz, external matching improves performance. Table 1 and Table 2 provide recommended components for device operation.

Digitally Controlled Attenuator

The digital attenuator is controlled through five logic lines: B0, B1, B2, B3, and B4. Table 3 lists the attenuation settings. The input and output of this attenuator require external DC-blocking capacitors. This attenuator insertion loss is 2dB when the attenuator is set to 0dB (B0 = B1 = B2 = B3 = B4 = 0).

Table 1. Suggested Components of Typical Application Circuit

COMPONENT	VALUE	SIZE
C1, C3, C4	1000pF	0603
C2, C5	100pF	0603
C6, C7	0.1μF	0603
C10	0.047μF	0603
R1	825Ω ±1%	0603
R2–R6	47kΩ	0603
L1	330nH	0805
L2	680nH	1008

Table 2. Suggested Matching Components

FREQUENCY	COMPONENT	VALUE	SIZE
300MHz	L3, L4	11nH	0603
	C8, C9	6.8pF	0603
400MHz	L3, L4	8.7nH	0603
	C8, C9	5pF	0603

IF Digitally Controlled Variable-Gain Amplifier

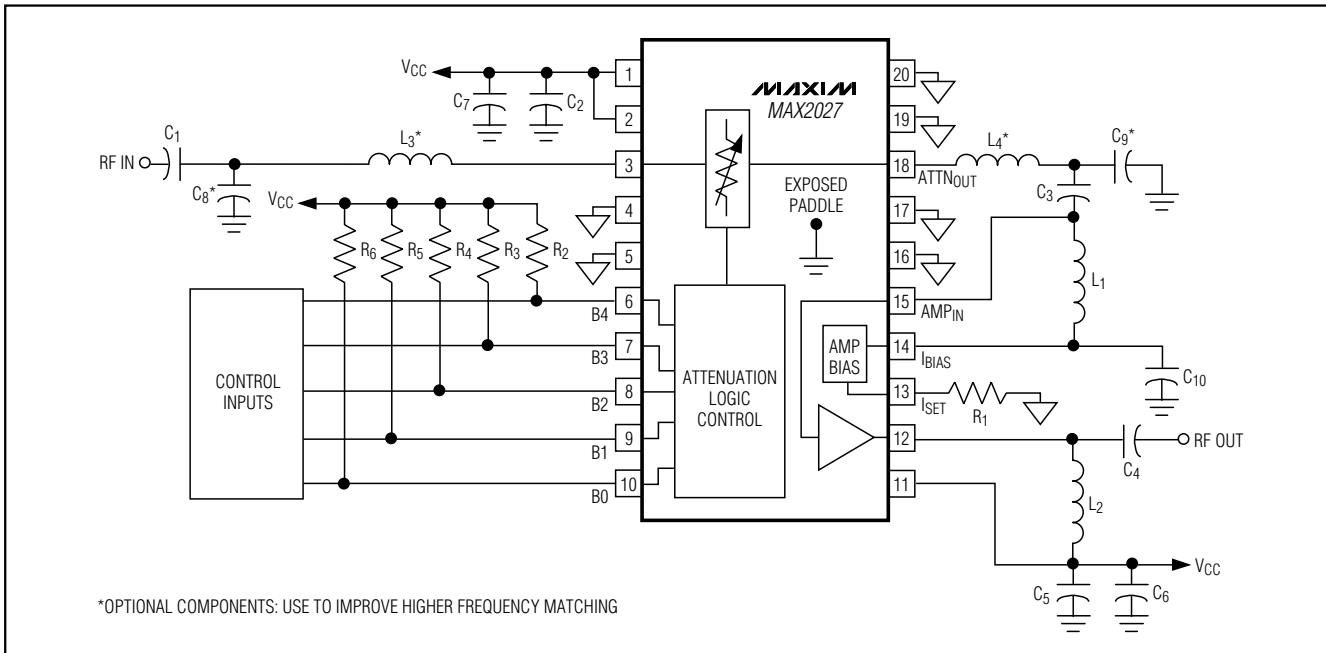

Figure 1. Typical Application Circuit

Fixed-Gain Amplifier

The MAX2027 integrates a fixed-gain amplifier in a negative feedback topology. This fixed-gain amplifier is optimized for a frequency range of operation from 50MHz to 400MHz with a high-output third-order intercept point (OIP3). The bias current is chosen to optimize the IP₃ of the amplifier. When R₁ is 825Ω, the current consumption is 60mA while exhibiting a typical 35dBm output IP₃.

Choke Inductor

The fixed-gain amplifier output port requires an external pullup choke inductor to V_{CC}. At the input, connect a bias inductor of 330nH from AMP_{IN} (pin 15) to IBIAS (pin 14). At the output, connect a 680nH choke inductor from RF_OUT (pin 12) to V_{CC} (pin 11) to provide bias current to the amplifier.

Layout Considerations

A properly designed PC board is an essential part of any RF/microwave circuit. Keep RF signal lines as short as possible to reduce losses, radiation, and induc-

tance. For the best performance, route the ground pin traces directly to the exposed pad under the package. The PC board exposed pad must be connected to the ground plane of the PC board. It is suggested that multiple vias be used to connect this pad to the lower level ground planes. This method provides a good RF/thermal conduction path for the device. Solder the exposed pad on the bottom of the device package to the PC board.

The MAX2027 Evaluation Kit can be used as a reference for board layout. Gerber files are available upon request at www.maxim-ic.com.

Power-Supply Bypassing

Proper voltage-supply bypassing is essential for high-frequency circuit stability. Bypass each V_{CC} pin with a 0.1μF and 100pF capacitor. Connect the 100pF capacitor as close to V_{CC} pins as possible.

Exposed Pad RF/Thermal Considerations

The exposed paddle (EP) of the MAX2027's 20-pin TSSOP-EP package provides a low thermal-resistance path to the die. It is important that the PC board on

IF Digitally Controlled Variable-Gain Amplifier

Table 3. Attenuation Setting vs. Gain-Control Bits

ATTENUATION (dB)	B4 (16dB)	B3* (8dB)	B2 (4dB)	B1 (2dB)	B0 (1dB)
0	0	0	0	0	0
1	0	0	0	0	1
2	0	0	0	1	0
3	0	0	0	1	1
4	0	0	1	0	0
5	0	0	1	0	1
6	0	0	1	1	0
7	0	0	1	1	1
8	0	1	0	0	0
9	0	1	0	0	1
10	0	1	0	1	0
11	0	1	0	1	1
12	0	1	1	0	0
13	0	1	1	0	1
14	0	1	1	1	0
15	0	1	1	1	1
16	1	X	0	0	0
17	1	X	0	0	1
18	1	X	0	1	0
19	1	X	0	1	1
20	1	X	1	0	0
21	1	X	1	0	1
22	1	X	1	1	0
23	1	X	1	1	1

*Enabling B4 disables B3, and the minimum attenuation is 16dB.

Chip Information
TRANSISTOR COUNT: 325

MAX2027

which the MAX2027 is mounted be designed to conduct heat from the EP. In addition, provide the EP with a low-inductance path to electrical ground. The EP must be soldered to a ground plane on the PC board, either directly or through an array of plated via holes.

IF Digitally Controlled Variable-Gain Amplifier

Package Information

(The package drawing(s) in this data sheet may not reflect the most current specifications. For the latest package outline information, go to www.maxim-ic.com/packages.)

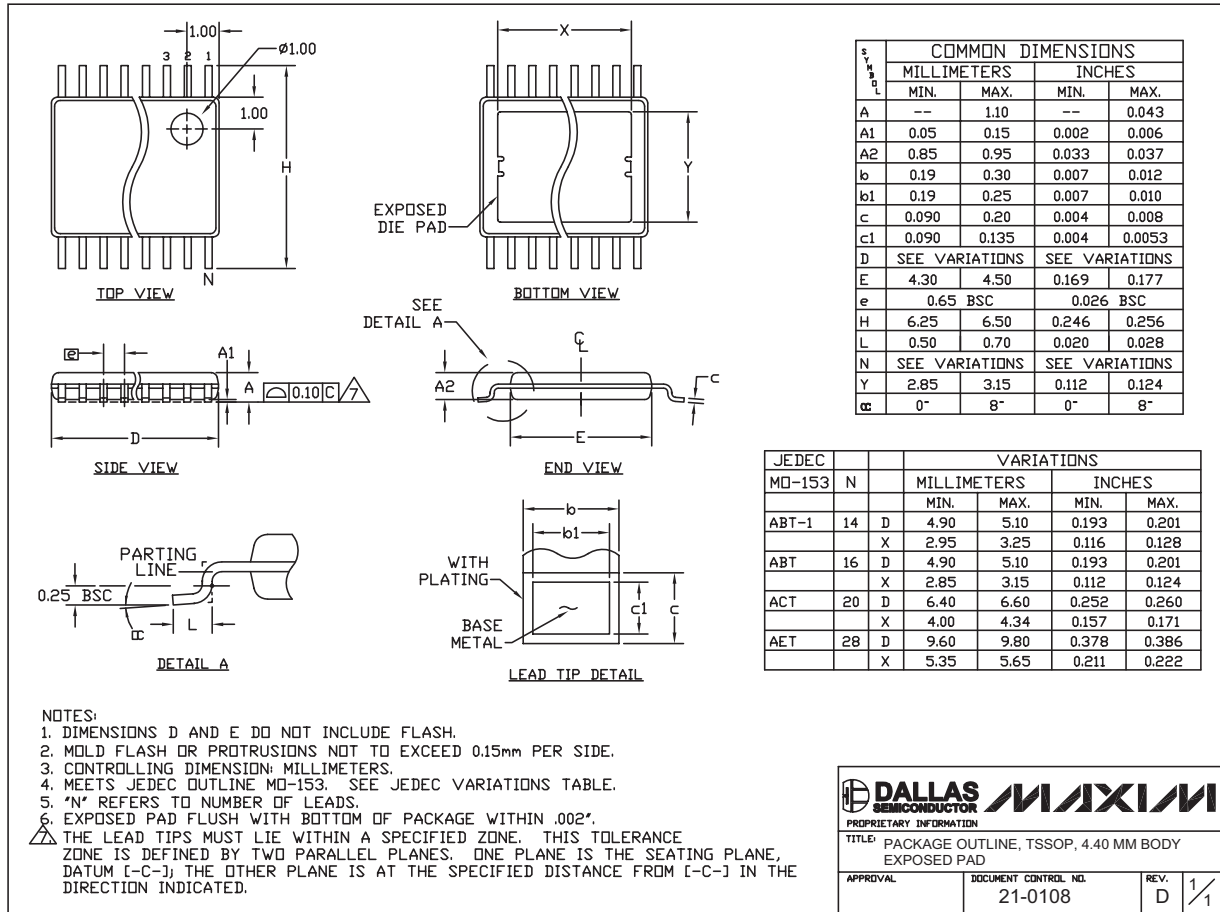

TSSOP 4.4mm BODY.EPS

DALLAS SEMICONDUCTOR **MAXIM**

PROPRIETARY INFORMATION

TITLE: PACKAGE OUTLINE, TSSOP, 4.40 MM BODY EXPOSED PAD

APPROVAL	DOCUMENT CONTROL NO. 21-0108	REV. D	1/1
----------	---------------------------------	-----------	-----

Maxim cannot assume responsibility for use of any circuitry other than circuitry entirely embodied in a Maxim product. No circuit patent licenses are implied. Maxim reserves the right to change the circuitry and specifications without notice at any time.

10 **Maxim Integrated Products, 120 San Gabriel Drive, Sunnyvale, CA 94086 408-737-7600**